



From Rysavy Research & 5G Americas



#SALMANQADIR

# Global 5G:

## Rise of a Transformational Technology

SEPT 2020



## Table of Contents

<b>INTRODUCTION.....</b>	<b>5</b>
<b>INTENSIFYING ROLE OF WIRELESS COMMUNICATIONS.....</b>	<b>7</b>
Global Mobile Adoption .....	8
Transformational Elements.....	10
Expanding Use Cases .....	12
<b>THE IMPACT OF 5G.....</b>	<b>16</b>
5G Rollout.....	16
1G to 5G Evolution.....	17
5G Technical Objectives.....	21
5G Applications .....	22
5G Frequency Use.....	25
5G Schedule.....	30
5G Device Availability .....	31
5G Phase One (Release 15).....	31
5G Phase Two (Release 16).....	34
5G Release 17 .....	35
5G Architecture .....	36
5G Performance.....	40
Dynamic Spectrum Sharing.....	41
5G Network Slicing.....	42
5G NR Cellular Positioning.....	46
5G Network Types and Operator Strategies.....	47
Integrated Access and Backhaul .....	49
<b>2020-2030 TECHNOLOGY EVOLUTION.....</b>	<b>51</b>
Application Evolution .....	52
Radio Evolution .....	54
Network Evolution.....	54
Distributed Computer Intelligence.....	56
Standards Evolution .....	56
Challenges toward this Future .....	57
<b>INTERNET OF THINGS AND INDUSTRIAL IOT.....</b>	<b>58</b>
<b>CELLULAR V2X COMMUNICATIONS.....</b>	<b>63</b>
<b>SPECTRUM DEVELOPMENTS.....</b>	<b>65</b>
3.55 to 3.70 GHz (CBRS).....	68
3.7 to 4.2 GHz (C-Band).....	68
3.1 to 3.55 GHz.....	70
2.5 GHz (EBS).....	71
6 GHz.....	71
5.850 to 5.925 GHz (DSRC) .....	71
5G mmWave Bands.....	72
Spectrum Sharing (CBRS, LSA) .....	74
Harmonization .....	77
Unlicensed Spectrum.....	79
<b>KEY SUPPORTING TECHNOLOGIES .....</b>	<b>80</b>
Virtualization and Cloud Native.....	80

O-RAN.....	83
Edge Computing .....	85
Artificial Intelligence (AI) .....	87
Unlicensed Spectrum Integration .....	91
Multiple Cell Types .....	95
Neutral-Host Small Cells .....	99
Massive MIMO .....	99
Multicast and Broadcast.....	100
Information-Centric Networking .....	101
<b>4G LTE ADVANCES.....</b>	<b>102</b>
LTE-Advanced and LTE-Advanced Pro Features.....	102
LTE 1 Gbps Capability.....	105
<b>3GPP RELEASES.....</b>	<b>106</b>
<b>FIXED WIRELESS ACCESS.....</b>	<b>108</b>
<b>VOLTE, 5G VOICE, RCS, WEBRTC, AND WI-FI CALLING .....</b>	<b>111</b>
Voice Support and VoLTE.....	111
5G Voice Support.....	112
Rich Communications Suite .....	112
WebRTC .....	113
Wi-Fi Calling.....	113
<b>PUBLIC SAFETY .....</b>	<b>114</b>
LTE Features for Public Safety .....	115
Deployment Approaches .....	117
<b>EXPANDING CAPACITY .....</b>	<b>119</b>
<b>CONCLUSION.....</b>	<b>123</b>
<b>APPENDIX: TECHNOLOGY DETAILS .....</b>	<b>124</b>
Spectral Efficiency.....	124
5G .....	134
Architecture in Detail .....	134
Architecture Options .....	139
C-V2X in Detail.....	141
NR-U in Detail .....	144
5G NR Cellular Positioning in Detail .....	155
Dynamic Spectrum Sharing in Detail .....	177
Integrated Access and Backhaul in Detail.....	180
Performance .....	182
Quality of Service .....	189
Spectrum Bands for 4G and 5G .....	191
3GPP Releases to Release 14.....	195
Data Throughput Comparison.....	197
Latency Comparison.....	203
Data Consumed by Streaming and Virtual Reality .....	204
LTE, LTE-Advanced, and LTE-Advanced Pro .....	205
LTE-Advanced and LTE-Advanced Pro.....	205
OFDMA and Scheduling .....	206
LTE Smart Antennas .....	208
LTE-Advanced Antenna Technologies.....	212
Carrier Aggregation .....	216
Coordinated Multi Point (CoMP) .....	220

User-Plane Congestion Management (UPCON) .....	222
Network-Assisted Interference Cancellation and Suppression (NAICS) .....	223
Multi-User Superposition Transmission (MUST) .....	223
IPv4/IPv6 .....	223
TDD Harmonization .....	223
SMS in LTE .....	224
User Equipment Categories .....	224
LTE-Advanced Relays .....	226
Proximity Services (Device-to-Device) .....	226
LTE Throughput .....	227
VoLTE and RCS .....	233
LTE Ultra-Reliable and Low-Latency Communications .....	239
Evolved Packet Core (EPC) .....	239
Heterogeneous Networks and Small Cells .....	242
Enhanced Inter-cell Interference Coordination .....	246
Dual Connectivity .....	251
Internet of Things and Machine to Machine .....	253
Cloud Radio-Access Network (RAN) and Network Virtualization for LTE .....	254
Other Unlicensed Spectrum Integration .....	257
Release 6 I-WLAN .....	258
Release 8 Dual Stack Mobile IPv6 and Proxy Mobile IPv6 .....	258
Release 11 S2a-based Mobility over GTP .....	258
Multipath TCP .....	259
ANDSF .....	259
Bidirectional Offloading Challenges .....	260
Other Integration Technologies (SIPTO, LIPA, IFOM, MAPCON) .....	261
Hotspot 2.0 .....	262
Self-Organizing Networks (SON) .....	264
IP Multimedia Subsystem (IMS) .....	266
Broadcast/Multicast Services .....	268
Backhaul .....	269
Remote SIM Provisioning .....	270
<b>ABBREVIATIONS AND ACRONYMS .....</b>	<b>270</b>
<b>ADDITIONAL INFORMATION .....</b>	<b>281</b>

# Introduction

With the global rollout of 5G networks, the wireless industry has taken another major step in transforming how people interact with the world. In terms of new subscriptions, 5G is the fastest growing generation of cellular wireless technology ever deployed.<sup>1</sup> By mid-2020, 5G was a commercial reality, with more than ninety 5G networks in operation.<sup>2</sup>

By supporting new application types and flexible spectrum use, including frequencies never before used in cellular systems, 5G provides a communications foundation for a future world—one of extended reality, autonomous cars, smart cities, wearable computers, and innovations not yet conceived. 5G will become essential to the economy through investment of hundreds of billions of dollars in infrastructure and creation of millions of new jobs.

4G LTE demonstrated how well wireless technology can support mobile and fixed broadband and Internet of Things (IoT). 4G LTE provides the underpinning for 5G to massively augment capacity, increase throughput speeds, decrease latency, and increase reliability, addressing applications never before possible with wireless connections. 5G will not replace LTE; in many cases, the two technologies will be tightly integrated and co-exist through at least the mid-2020s.

Early deployments based on the first phase 5G standard, emphasizing enhanced mobile broadband, are accelerating, and many 5G devices are already available. The more complete 5G standard, which adds support for items such as Industrial IoT, Integrated Access and Backhaul (IAB), operation in unlicensed spectrum, and vehicle communications, was completed in 2020. Just as LTE continually advanced throughout this decade, so will 5G be constantly enhanced in successive versions of the standard.

Computer intelligence in devices, combined with cloud computing and now edge clouds, is creating a distributed computing environment. This environment, combined with other innovations, such as AI, will result in entirely new consumer and business applications.

Because long-term growth in smartphone and other mobile device use is limited by population, innovators are concentrating on IoT, which already encompasses a wide array of applications. Enhancements to LTE, followed by 5G IoT capabilities, are assisting wearable computers, making cities smarter, facilitating industrial automation, driving adoption of connected autonomous vehicles, and improving health. 5G not only addresses IoT deployments on a huge scale, but also enables applications that depend on ultra-reliable and low-latency communications, paving the way for vast deployments of Industrial IoT.

This paper captures the scope of the industry's current developments, beginning with a summary of the most important developments in Table 1.

---

<sup>1</sup> 5G Americas, "5G's Year One: Fast Start and Healthy Growth," Mar. 23, 2020. <https://www.5gamericas.org/5gs-year-one-fast-start-and-healthy-growth/>.

<sup>2</sup> 5G Americas, "5G & LTE Deployments." <https://www.5gamericas.org/resources/deployments/>, accessed Jul. 16, 2020.

**Table 1: Most Important Wireless Industry Developments in 2020**

Development	Summary
<b>5G Deployment Accelerating</b>	Operators globally continue to deploy 5G in a variety of bands, including low-band, mid-band, and mmWave bands. More than 100 5G devices are now available. <sup>3</sup>
<b>5G Now Fully Specified in 3GPP Releases 15 and 16</b>	3GPP has completed specifications for both Release 15 and Release 16, addressing a range of use cases far beyond LTE. The 5G New Radio (NR) specified in Release 15 supports low-latency, beam-based channels, operation to 52.6 GHz, massive Multiple Input Multiple Output (MIMO) with large numbers of controllable antenna elements, scalable-width subchannels, carrier aggregation, cloud Radio-Access Network (RAN) capability, and coexistence with LTE. Release 16 focuses on enterprise applications with ultra-reliable low-latency communications, operation in unlicensed spectrum, integrated access and backhaul, vehicle communications, industrial IoT, and efficiency and performance enhancements.
<b>5G Innovation Continues with Release 17</b>	Release 17 work has begun to define support for low-complexity devices, operation in 52.6 to 71 GHz, satellites, multiple SIMs, NR multicast and broadcast, and a wide range of feature enhancements.
<b>Standalone Architecture</b>	Operators are transitioning to standalone architecture, which will improve performance, enable slicing, support industrial IoT, and facilitate edge computing.
<b>Fiber Densification</b>	The eventual hundreds of thousands of new small cells to support dense 5G networks will require extensive amounts of new fiber. Planned 5G capabilities, such as IAB, however, will mean not every base station has to have a fiber connection, especially at mmWave frequencies.
<b>Harnessing Spectrum Never Before Feasible</b>	Radio methods including massive MIMO and beamforming are enabling use of spectrum above 6 GHz that was never previously feasible for cellular networks. The huge amounts of spectrum above 6 GHz will result in wider channels with correspondingly faster data rates, capacity gains, or a combination thereof.
<b>Internet of Things Poised for Wide-Scale Adoption</b>	IoT, evolving from machine-to-machine (M2M) communications, is seeing rapid adoption, with tens of billions of new connected devices expected over the next decade.  Drivers include improved LTE and NR support, such as low-cost and low-power modems, enhanced coverage, and higher densities. Network slicing, edge computing, and private networks in 5G will further accelerate deployment.
<b>Unlicensed Spectrum Becomes More Tightly</b>	The industry is now deploying versions of LTE that can operate in unlicensed spectrum, such as LTE-Unlicensed (LTE-U), LTE-Licensed Assisted Access (LTE-LAA), and MulteFire. <sup>4</sup> NR support for unlicensed spectrum is now available in Release 16 of the 5G standard.

<sup>3</sup> GSA, "5G Ecosystem – July 2020 – Devices update," Jul. 2020. <https://gsacom.com/paper/5g-ecosystem-july-2020-devices-update/?utm=devicereports5g>.

<sup>4</sup> Specified by the MulteFire Alliance.

Development	Summary
<b>Integrated with Cellular</b>	
<b>Spectrum Remains Essential</b>	<p>Spectrum in general, and licensed spectrum in particular, remains essential for the industry.</p> <p>Forthcoming new spectrum in the United States includes the 3.5 GHz Citizens Broadband Radio Service (CBRS), with up to 70 MHz of licensed spectrum, and 280 MHz of mid-band spectrum in the C-band.</p>
<b>Small Cells Accelerating</b>	<p>Operators have begun installing small cells, which now occupy more than 100,000 outdoor sites in the United States. Eventually, hundreds of thousands, if not millions, of small cells will increase capacity and provide a viable alternative to wireline broadband.</p> <p>The industry is slowly overcoming challenges that include restrictive regulations, site acquisition, self-organization, interference management, power, and backhaul, but deployment remains a challenge.</p>
<b>Network Function Virtualization (NFV) Emerges and Proves Central to 5G</b>	<p>Network function virtualization (NFV) and software-defined networking (SDN) tools and architectures are enabling operators to reduce network costs, simplify deployment of new services, reduce deployment time, and scale their networks.</p> <p>The Open RAN Alliance (O-RAN) is standardizing interfaces to enable the disaggregation of the radio access network, embracing intelligence and openness.</p>
<b>Edge Computing Deployment Begins</b>	<p>Operators are deploying edge clouds to reduce server latencies and the traffic volume across backbone networks, benefiting applications such as IoT data processing, video processing, augmented reality, virtual reality, cloud gaming, and connected cars.</p>
<b>5G Potential Synergistic with AI</b>	<p>Artificial intelligence will optimize network efficiency, make devices easier to use, enable new applications, and leverage a hybrid architecture of central cloud, edge clouds, and device computing capability.</p>

The main part of this paper covers the intensifying role of wireless communications, the impact of 5G, 2020 to 2030 evolution, IoT and industrial IoT, cellular communications, spectrum developments, key supporting technologies, 4G LTE advances, 3GPP releases, fixed wireless access, voice support, public safety, and capacity expansion.

The appendix delves into more technical aspects of the following topics: spectral efficiency, 5G in detail, spectrum bands, 3GPP releases, data throughput, latency, LTE, heterogeneous networks and small cells, Internet of Things, cloud RAN, unlicensed spectrum integration, self-organizing networks, the IP multimedia subsystem (IMS), broadcast/multicast, backhaul, remote SIM provisioning, UMTS-HSPA, and EDGE/GRPS.

## Intensifying Role of Wireless Communications

Wireless technology is playing an ever-increasing role in the economy. By harnessing more spectrum and achieving ever greater efficiency, wireless technology will not only continue to support pervasive mobile computing but also rapidly displace many fixed broadband

connections and connect vast numbers of items in the environment. This section addresses global adoption of wireless technologies, transformational elements, expanding use cases, fixed wireless access, and the Internet of Things.

## Global Mobile Adoption

Until now, mobile broadband has been the key driver for wireless technology deployment, and indeed, enhanced mobile broadband was the focus of the first phase of the 5G standard.<sup>5</sup> Today's smartphones and tablets, dominated by the iOS and Android ecosystems combined with sophisticated cloud-based services, provide a stable, well-defined application environment that allows developers to target billions of users.

Figure 1 shows an Ericsson data projection for the 2015 to 2025 period.

**Figure 1: Global Mobile Data Traffic (Exabytes/Month) 2015 to 2025<sup>6</sup>**

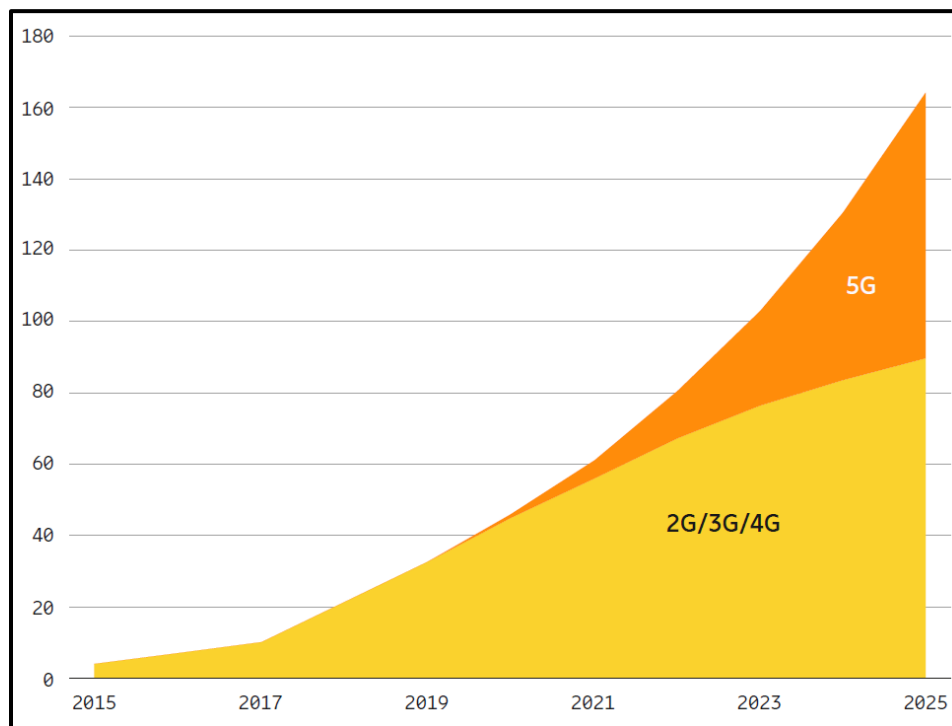

The faster 5G speeds are accelerating data usage. For example, in May 2019, Korea's Ministry of Science and ICT (MSIT) reported 18.3 GBytes/month of data usage by 5G users compared to 9.0 GBytes/month for 4G users.<sup>7</sup>

---

<sup>5</sup> 3GPP Release 15.

<sup>6</sup> Ericsson, *Ericsson Mobility Report*, Jun. 2020.

<sup>7</sup> Samsung, *5G Launches in Korea*, 2019.  
<https://images.samsung.com/is/content/samsung/p5/global/business/networks/insights/white->



Billions of devices will also employ wireless connections. Figure 2 from Cisco shows the growth of cellular IoT through 2023, reaching 4.4 billion connections by 2023.

**Figure 2: Global Mobile IoT (Billions)<sup>8</sup>**

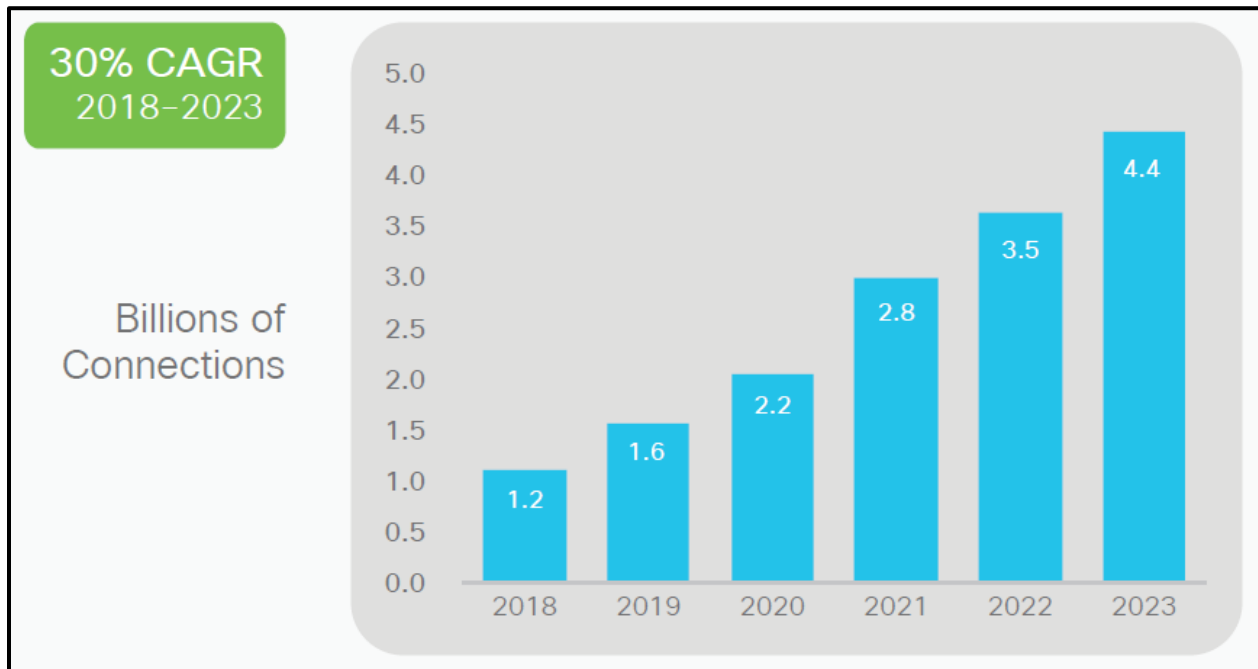

In June 2020, 9.12 billion GSM-HSPA-LTE active connections were in effect<sup>9</sup>—more than the world’s 7.66 billion population.<sup>10</sup> By the end of 2024, the global mobile broadband market is expected to include 10.3 billion subscribers.<sup>11</sup> 1.3 billion subscribers will be on 5G, representing 12.6% market share.<sup>12</sup>

LTE has experienced faster deployment than any mobile technology ever developed. All major U.S. operators now offer nationwide LTE coverage. LTE has also been chosen by U.S. national public safety organizations as their broadband technology of choice.

As shown in Figure 3, 2G GSM has peaked and is now declining, as are CDMA and WCDMA/HSPA. LTE subscriptions will continue to rise for one more year. By 2025, 5G will represent almost 30% of market share.

---

[paper/5g-launches-in-korea-get-a-taste-of-the-future/5G-Launches-in-Korea-Get-a-taste-of-the-future.pdf](#).

<sup>8</sup> Cisco, *Annual Internet Report (2018-2023)*, Mar 2020.

<sup>9</sup> Omdia, Jul. 2020.

<sup>10</sup> U.S. Census Bureau, “U.S. and World Population Clock,” <http://www.census.gov/popclock/>, accessed Jul. 13, 2020.

<sup>11</sup> Omdia, Jul. 2020.

<sup>12</sup> *Ibid.*

**Figure 3: Mobile Subscriptions by Technology (Billions)<sup>13</sup>**

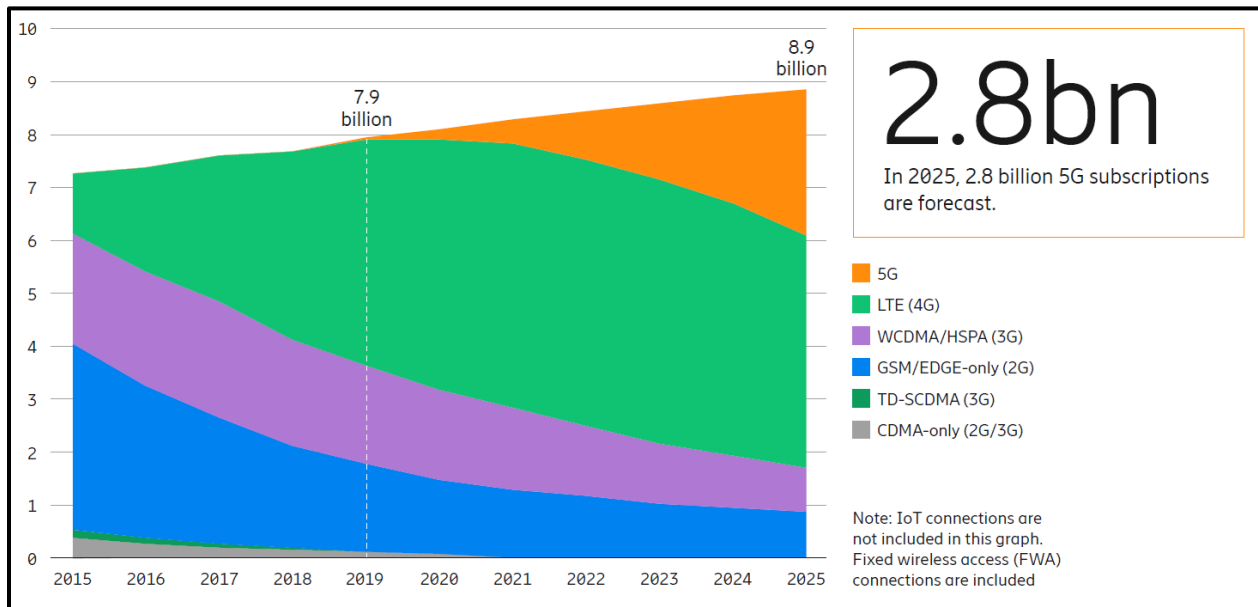

### ***Transformational Elements***

Many elements are interacting to transform wireless technology, but the most important factors are radio advances that grant access to far more spectrum, increased radio performance through massive MIMO, specific capabilities for IoT, network densification, new network architectures that leverage network function virtualization and software-defined networking, and new means to employ unlicensed spectrum. Except for the 5G objective of high-band spectrum access, these advances apply to both LTE and 5G.

<sup>13</sup> Ericsson, *Ericsson Mobility Report*, Jun. 2020.

**Figure 4: Fundamental Transformational Elements**

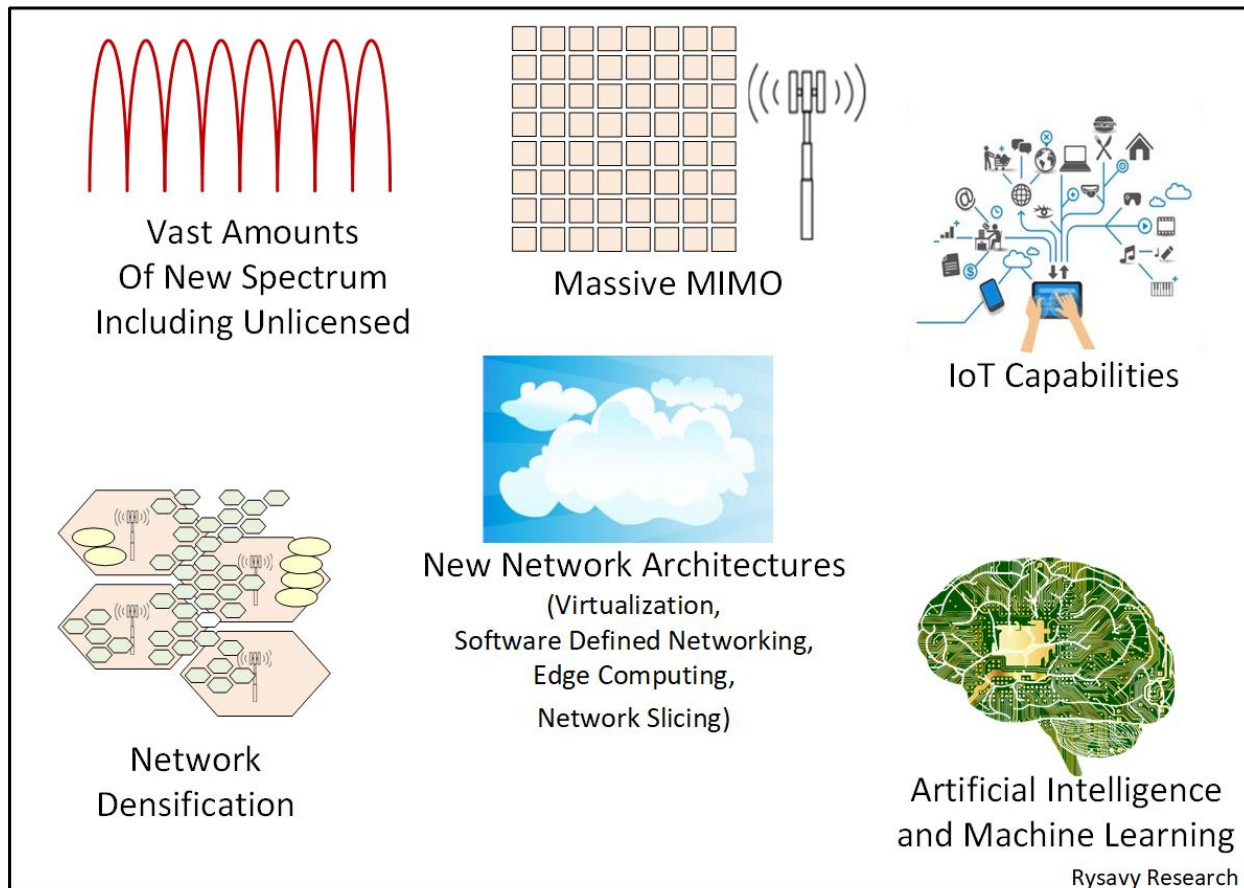

Throughout radio history, technology has climbed a ladder to use higher frequencies; the initially dubbed “ultra-high frequencies” made available for television are now considered low-band frequencies for cellular. Frequencies above 6 GHz, particularly mmWave frequencies that begin at around 24 GHz, are the new frontier. Networks will ultimately increase current spectrum usage by tenfold, using even more as radio technology crosses 100 GHz and begins to exploit terahertz frequencies. Although higher frequencies pose challenges such as propagation limitations and higher penetration loss, methods such as massive MIMO, beam steering, beam tracking, dual connectivity, carrier aggregation, and small-cell architectures with self-backhauling help mitigate these challenges.

In addition to accessing higher bands, cellular technologies are integrating unlicensed spectrum more efficiently with technologies such as LAA in LTE. 5G in Release 16 allows similar approaches with NR in a capability called “NR-U.”

Small cells, on the roadmap for many years but held back by implementation difficulties such as backhaul, are now proceeding with large-scale deployments. These deployments will ultimately lead to densities as high as four to ten small cells for every macro cell.

Meanwhile, networks are becoming programmable. Using a distributed, software-enabled network based on virtualization, operators and third parties can deploy new services and applications more rapidly and in a more scalable fashion. This distributed computing architecture, along with cloud services and powerful device computers, will allow AI to make networks more efficient and able to deliver entirely new services.

For millions, and ultimately billions of people, wireless connections will be the only connections that they need. These networks will also provide the foundation for entire new industries not yet conceived.

Beyond human-to-human communications, LTE and 5G have many features to address the huge opportunity of communications between things. The emphasis of 5G is to expand the use cases for wireless communications, as discussed next.

## ***Expanding Use Cases***

The International Telecommunication Union (ITU)'s 5G recommendations divides use cases into the three main categories shown in Figure 5.

- ❑ **Enhanced Mobile Broadband (eMBB).** eMBB is the most obvious extension of LTE capability, providing higher throughputs for applications such as streaming, Web access, video conferencing, and virtual reality. Highest throughputs will occur in small cells with limited movement speed of end users, such as pedestrians. This is the emphasis of the first phase of 5G, specified in Release 15 of 3GPP specifications.
- ❑ **Massive Machine-Type Communications (mMTC).** Massive machine-type communications capability extends LTE Internet of Things capabilities—for example, NB-IoT—to support huge numbers of devices with lower costs, enhanced coverage, and long battery life. As shown in the ITU objectives below, 5G supports ten times as many devices in an area as LTE.
- ❑ **Ultra-Reliable and Low-Latency Communications (URLLC).** Of the three categories, URLLC enables new wireless applications requiring low latency. Driven by high dependability and extremely short network traversal time, URLLC, also referred to as “mission-critical” communications, enables industrial automation, drone control, new medical applications, and autonomous vehicles. This category is also referred to as critical machine-type communications (cMTC).

**Figure 5: ITU Use Case Model<sup>14</sup>**

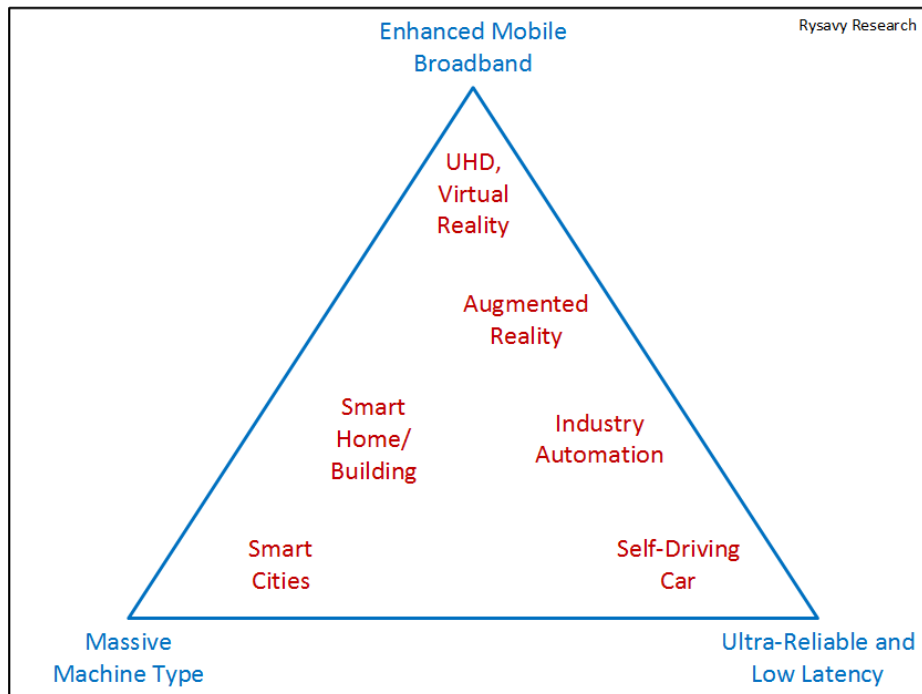

In a project called “SMARTER,” 3GPP identified multiple specific use cases for 5G, consistent with ITU’s model.<sup>15</sup>

With increased capabilities in successive 5G releases, 5G (and LTE) will evolve from supporting business-critical communications to mission-critical communications, as shown in Figure 6.

---

<sup>14</sup> For background, see ITU, *IMT Vision – Framework and overall objectives of the future development of IMT for 2020 and beyond*, Recommendation ITU-R M.2083-0, Sep. 2015.

<sup>15</sup> 3GPP TR22.891, *Feasibility Study on New Services and Markets Technology Enablers*; TR22.861 (Massive Internet of Things); TR22.862 (Critical Communications); TR 22.863 (Enhanced Mobile Broadband); TR22.864 (Network Operation).

**Figure 6: Evolution from Business-Critical to Mission-Critical Communications<sup>16</sup>**

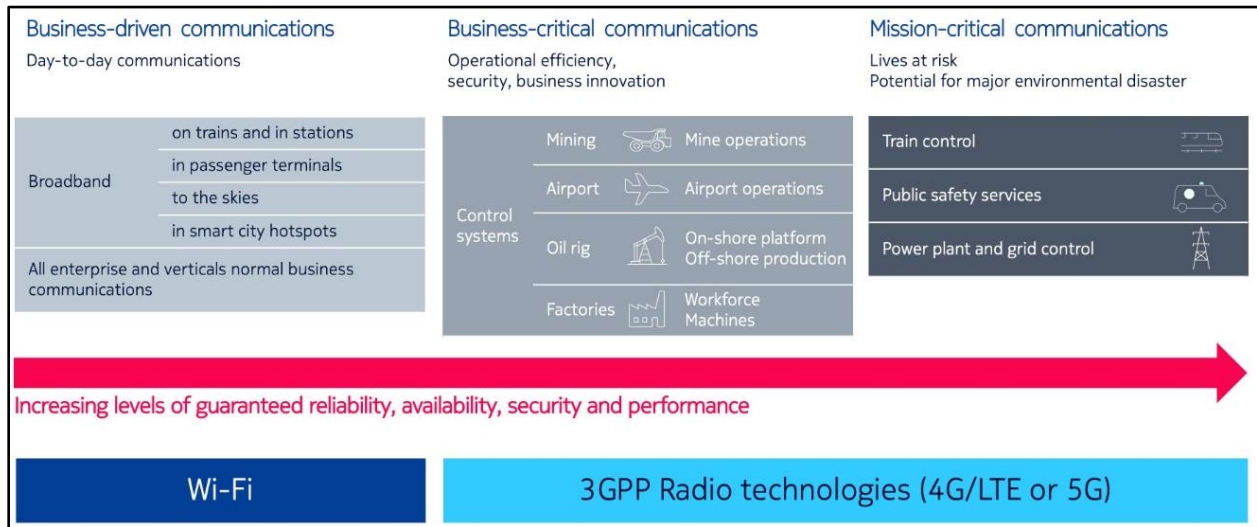

Figure 7 shows different use case requirements for throughput, latency, and reliability.

**Figure 7: Requirements for Different 5G Use Cases<sup>17</sup>**

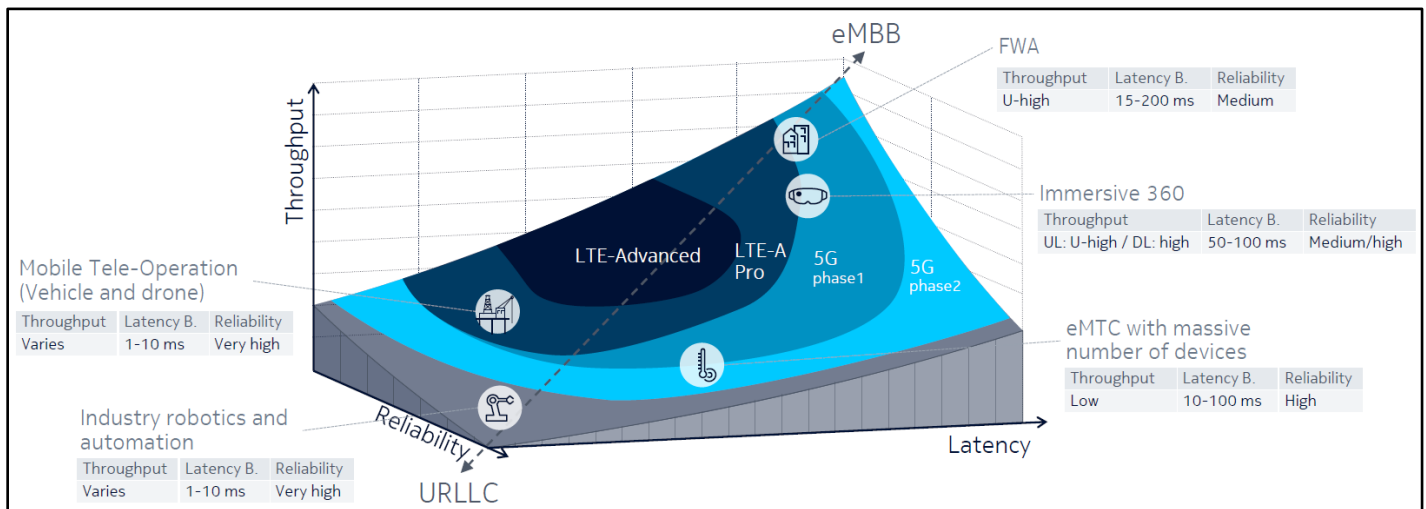

Figure 8 compares the ability of LTE and 5G to address ITU use case categories. For mobile broadband and IoT, 5G significantly augments LTE capabilities. With mission-critical support, however, 5G will introduce capabilities to address many new applications not previously feasible with 4G.

<sup>16</sup> Nokia contribution. Nokia, *Industrial-grade private wireless for Industry 4.0 applications*, 2019. <https://pf.content.nokia.com/t004f8-why-private-wireless/white-paper-industrial-grade-private-wireless-for-industry-4-0-applications>.

<sup>17</sup> Nokia contribution. See also Ericsson discussion, "5G Use Cases." <https://www.ericsson.com/en/5g/use-cases>.

**Figure 8: Comparison of Use Case Categories between LTE and 5G<sup>18</sup>**

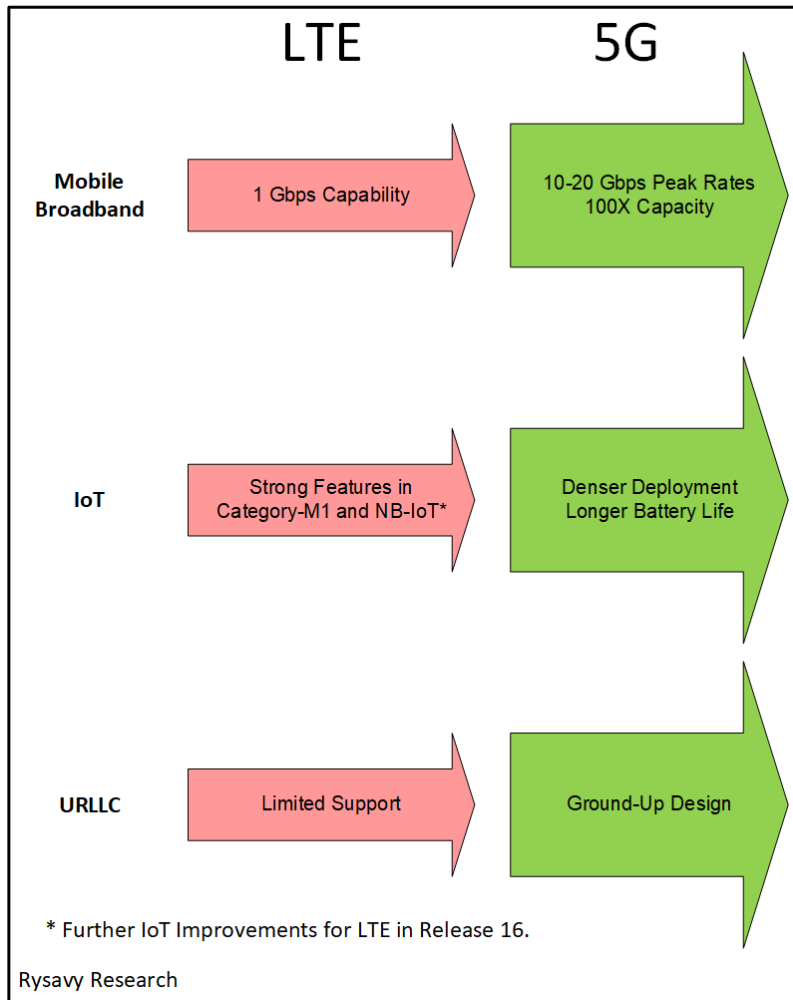

Table 2 summarizes the requirements of the expanding number of use cases that employ wireless technology. The exact values are not as important as how different the requirements are across varied use cases; the value of 5G is its broad use case support.

**Table 2: Requirements for Different Use Cases<sup>19</sup>**

Use Cases	Requirements	Desired Value
Autonomous vehicle control	Latency	5 msec
	Availability	99.999 percent
	Reliability	99.999 percent
Emergency communication	Availability	99.9 percent victim discovery rate
	Energy efficiency	One-week battery life
Factory cell automation	Latency	Down to below 1ms

<sup>18</sup> 100X capacity of 5G over LTE, as explained later in the paper in the section “5G Frequency Use,” assumes access to more spectrum, denser networks, and extensive use of massive MIMO.

<sup>19</sup> Ericsson, *5G Systems – Enabling the Transformation of Industry and Society*, Jan. 2017. <https://www.ericsson.com/assets/local/publications/white-papers/wp-5g-systems.pdf>. Adapted from Table 1.

Use Cases	Requirements	Desired Value
	Reliability	Down to packet loss of less than 10 <sup>-9</sup>
High-speed train	Traffic density	Downlink (DL): 100Gbps/km <sup>2</sup> , uplink (UL): 50 Gbps/km <sup>2</sup>
	User throughput	DL: 50Mbps, UL: 25Mbps
	Mobility	500 km/h
	Latency	10ms
Large outdoor event	User throughput	30Mbps
	Traffic density	900Gbps/km <sup>2</sup>
	Connection density	Four devices/m <sup>2</sup>
Massive IoT	Connection density	1,000,000 devices/km <sup>2</sup>
	Availability	99.9 percent coverage
	Energy efficiency	10-year battery life
Remote surgery and examination	Latency	Down to 1ms
	Reliability	99.999 percent
Smart city	User throughput	DL: 300Mbps, UL: 60Mbps
	Traffic density	700 Gbps/km <sup>2</sup>
	Connection density	200,000 devices/km <sup>2</sup>
Virtual and augmented reality	User throughput	4-28Gbps
	Latency	< 7msec
Broadband to the home	Connection density	4,000 devices/km <sup>2</sup>
	Traffic density	60Gbps/km <sup>2</sup>

## The Impact of 5G

3GPP completed the first 5G specification in early 2018, enabling deployment of standards-based networks in late 2018. This section on 5G explains the 5G rollout, 1G-to-5G evolution, technical objectives, applications, frequency use, schedule, devices, details of Release 15 through 17, architecture, performance, network slicing, NR cellular positioning, network types, operator strategies, and Integrated Access and Backhaul.

### **5G Rollout**

Figure 9 shows key capabilities and deployment types over time. Today's networks, based on Release 15 specifications, emphasize enhanced mobile broadband, whereas Releases 16 and 17 emphasize capabilities of greater interest to enterprises, such as URLLC and industrial IoT.



**Figure 9: Key Capabilities and Deployment Over Time**

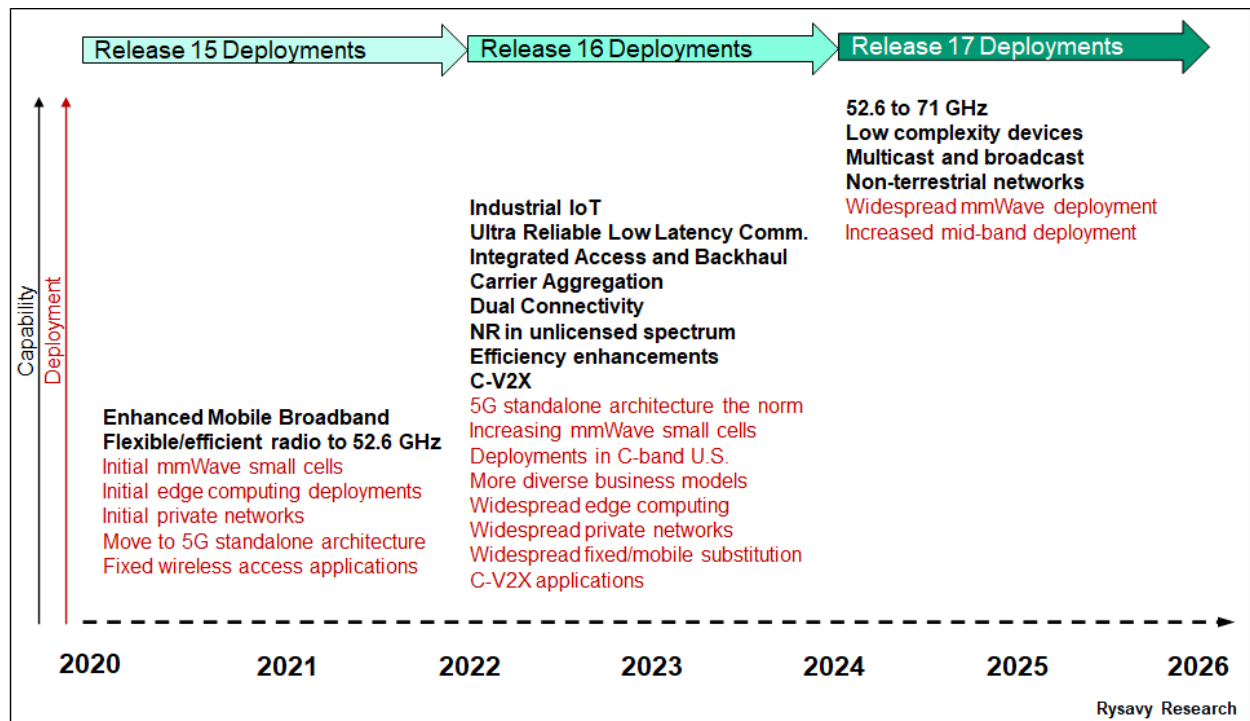

The rollout of 5G in these stages ensures a smooth transition from 4G LTE by initially targeting the smartphone market. With Release 16 deployments beginning in the 2022 timeframe, however, operators will have greater flexibility as to which business models they pursue. Given the wide range of new applications that Release 16 will support (as discussed in the section “5G Applications” below), some operators could, for example, emphasize fixed wireless access, whereas others might pursue industrial automation or smart cities. As a result, different operators may emphasize deployment in different spectrum bands to find the best fit between their network capabilities and target use cases.

## 1G to 5G Evolution

For historical context, “1G” refers to analog cellular technologies that became available in the 1980s. “2G” denotes initial digital systems that became available in the 1990s that introduced services such as short messaging and lower-speed data. 3G requirements were specified by the International Telecommunication Union (ITU) as part of the International Mobile Telephone 2000 (IMT-2000) project, which focused significantly on voice capacity improvement, and digital networks had to provide 144 Kbps of throughput at mobile speeds, 384 Kbps at pedestrian speeds, and 2 Mbps in indoor environments. UMTS-HSPA and CDMA2000 are the primary 3G technologies. 3G technologies began to be deployed early last decade and will begin to decline in usage as 4G and 5G become prevalent.

In 2008, the ITU issued requirements for IMT-Advanced, which many people initially used as a definition of 4G. The focus on 4G was to improve data coverage, capacity, and quality of experience. Requirements included operation in up to-40 MHz radio channels and extremely high Spectral Efficiency. The ITU required peak spectral efficiency of 15 bps/Hz and recommended operation in up-to-100 MHz radio channels, resulting in a theoretical throughput rate of 1.5 Gbps. In 2009 and 2010, the term “4G” became associated with

mobile broadband technologies deployed at the time, such as HSPA+, WiMAX, and initial LTE deployments. Today, 4G usually refers to HSPA+ or LTE.

The ITU defined 5G requirements in IMT-2020, and since then, 3GPP has developed specifications that address those requirements.

Table 3 summarizes the generations of wireless technology.

**Table 3: 1G to 5G**

Generation	Requirements	Comments
<b>1G</b>	No official requirements.  Analog technology.  First mobile networks, emphasizing voice service.	Deployed in the 1980s.  Analog technologies such as Advanced Mobile Phone Service (AMPS) and Nordic Mobile Telephone (NMT). NMT had simple integrated data and messaging.
<b>2G</b>	No official requirements.  Digital technology for voice and circuit-switched data, followed by packet-switched data.	First digital systems.  Deployed in the 1990s.  New services such as SMS and low-rate data.  Primary technologies include IS-95 CDMA (cdmaOne), IS-136 (D-AMPS/TDMA), and GSM/GPRS/EDGE.
<b>3G</b>	ITU's IMT-2000 required 144 Kbps mobile, 384 Kbps pedestrian, 2 Mbps indoors.	First deployment in 2000.  Primary technologies include CDMA2000 1X/EV-DO and UMTS-HSPA.  WiMAX.
<b>4G (Initial Technical Designation)</b>	ITU's IMT-Advanced requirements include the ability to operate in up-to-40-MHz radio channels and with very high spectral efficiency.	First deployment in 2010.  IEEE 802.16m and LTE-Advanced meet the requirements.
<b>4G (Current Marketing Designation)</b>	Systems that significantly exceed the performance of initial 3G networks. No quantitative requirements.	Today's HSPA+, LTE, and WiMAX networks meet this requirement.
<b>5G</b>	ITU IMT-2020 defined technical objectives, and 3GPP has developed and is continuing to develop 5G	First standards-based deployments began in 2018. <sup>21</sup> Rapid deployment in 2020.

<sup>21</sup> AT&T, "AT&T First to Make Mobile 5G Service Live in the U.S. on Dec. 21," Dec. 18, 2018. [https://about.att.com/story/2018/att\\_brings\\_5g\\_service\\_to\\_us.html](https://about.att.com/story/2018/att_brings_5g_service_to_us.html).

Generation	Requirements	Comments
	specifications. <sup>20</sup> Requirements include three-times higher spectral efficiency than 4G and peak downlink throughputs to 20 Gbps.	

The interval between each significant technology platform has been about ten years. Within each platform, however, innovators keep improving the technology. For example, with 2G technology, EDGE significantly improved data performance compared with initial General Packet Radio Service (GPRS) capabilities. Similarly, HSPA hugely increased data speeds compared with initial 3G capabilities. LTE and LTE-Advanced also acquired continual improvements over the past decade, including faster speeds, greater efficiency, and the ability to aggregate spectrum more flexibly. 5G capabilities will continue to improve throughout this decade.

At a high level, 4G LTE provides a foundation of capability and knowledge on which 5G (NR and LTE) will grow, as shown in Figure 10.<sup>22</sup>

---

<sup>20</sup> Other organizations, as discussed below, are developing related specifications, such as for virtualization.

<sup>22</sup> Note that Release 15 LTE-Advanced Pro was submitted to the ITU for IMT-2020 approval as a Set of Radio Interface Technologies (SRIT), along with the other SRIT component of NR, and the entire package was named by 3GPP as "5G".

**Figure 10: Initial LTE as Foundation for 5G Enhancements**

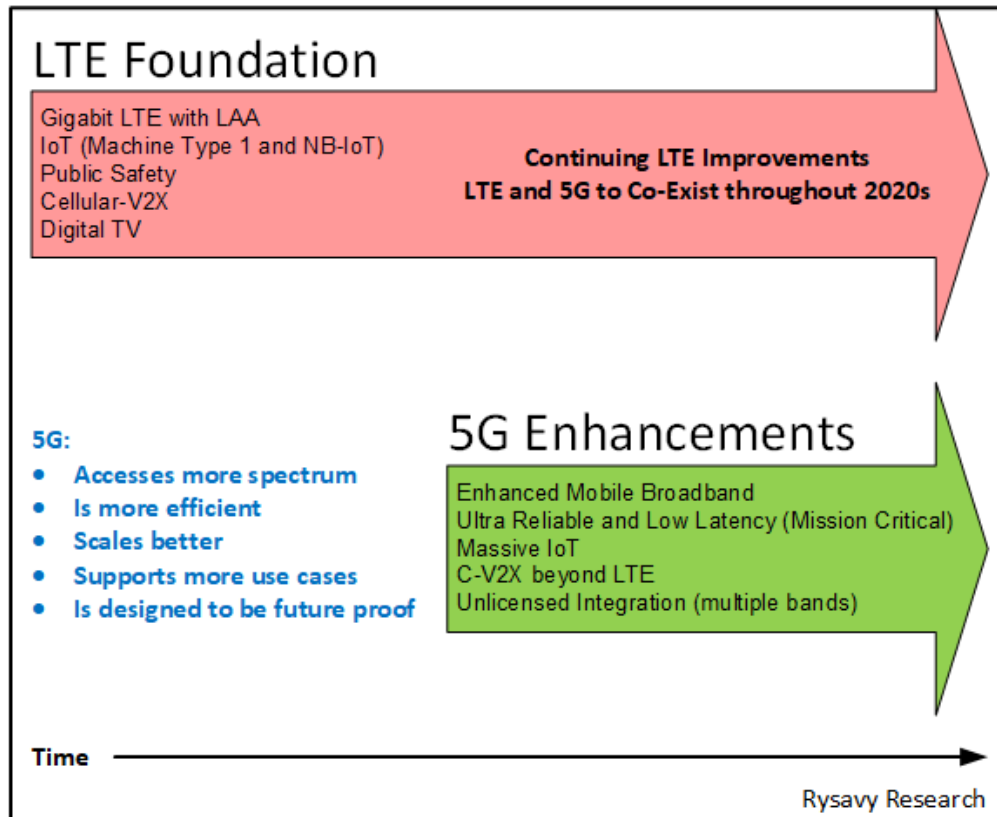

Because each generation of cellular technology is more efficient, the cost of delivering data decreases, and so prices are lower for users, expanding the number of feasible applications. The same will be true with 5G, as analyzed in an Ericsson report and shown in Figure 11.<sup>23</sup> The report states, “A site fully evolved with 4G and 5G capacity will deliver mobile data 10 times more cost efficiently than a basic 4G site does today.”

<sup>23</sup> Ericsson, *The 5G Consumer Business Case – An Economic Study of Enhanced Mobile Broadband*, 2018.

**Figure 11: Reduced Cost per GB of 5G Compared to 4G**

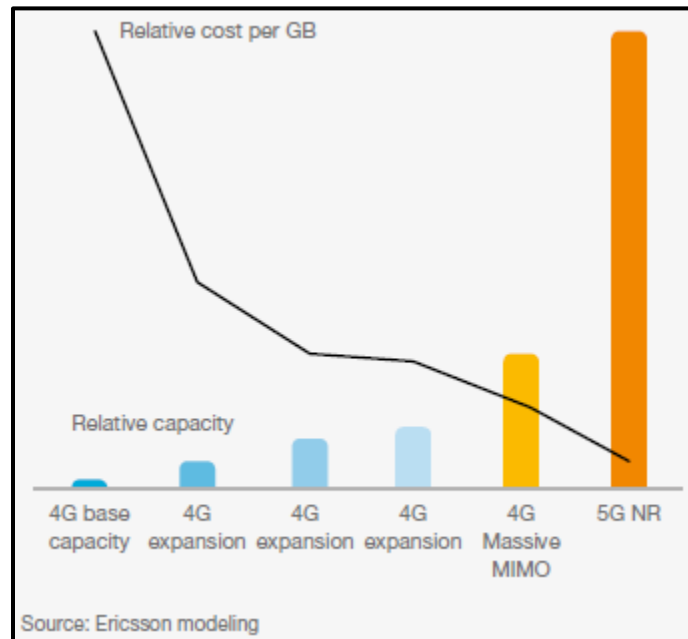

## 5G Technical Objectives

Table 4 shows the ITU's objectives for IMT-2020 (5G) relative to IMT-Advanced (4G).

**Table 4: ITU Objectives for IMT-2020 compared with IMT-Advanced<sup>24</sup>**

	IMT-Advanced	IMT-2020
<b>Peak Data Rate</b>	DL: 1 Gbps UL: 0.05 Gbps	DL: 20 Gbps UL: 10 Gbps
<b>User Experienced Data Rate</b>	10 Mbps	100 Mbps <sup>25</sup>
<b>Peak Spectral Efficiency</b>	DL: 15 bps/Hz UL: 6.75 bps/Hz	DL: 30 bps/Hz UL: 15 bps/Hz
<b>Average Spectral Efficiency</b>		DL eMBB indoor: 9 bps/Hz DL eMBB urban: 7.8 bps/Hz DL eMBB rural: 3.3 bps/Hz  UL eMBB indoor: 6.75 bps/Hz UL eMBB urban: 5.4 bps/Hz UL eMBB rural: 1.6 bps/Hz
<b>Mobility</b>	350 km/h	500 km/h

<sup>24</sup> ITU Working Party 5D, *Minimal Requirements Related to Technical Performance for IMT-2020 Radio Interfaces*, Feb 22, 2017. See also 3GPP TR 38.913, *Study on Scenarios and Requirements for Next Generation Access Technologies (Release 14)*, V14.2.0, Mar. 2017.

<sup>25</sup> Per ITU, "User experienced data rate is the 5% point of the cumulative distribution function (CDF) of the user throughput."

	IMT-Advanced	IMT-2020
<b>User Plane Latency</b>	10 msec	1 msec <sup>26</sup>
<b>Connection Density</b>	100 thousand devices/sq.km.	1 million devices/sq.km.
<b>Network Energy Efficiency</b>	1 (normalized)	100X over IMT-Advanced
<b>Area Traffic Capacity</b>	0.1 Mbps/sq. m.	10 Mbps/sq. m. (hot spots)
<b>Bandwidth</b>	Up to 20 MHz/radio channel (up to 100 MHz aggregated)	Up to 1 GHz (single or multiple RF carriers)

Analysis performed by 5G Americas member organizations shows that 5G NR will meet the ITU objectives.<sup>27</sup>

In supporting different usage scenarios, not all of these objectives will necessarily be simultaneously available. For example, an IoT application may need to support a large number of devices but at lower throughput rates, while a vehicular application may need high mobility and low latency.

Figure 7 above shows these tradeoffs.

## 5G Applications

As mentioned, 5G dramatically increases the number of use cases and potential applications for wireless connectivity. The wide 5G connection between devices and virtually unlimited computing power at the edge and in the cloud means that users can expect boundless innovation. Based on experience with 4G, a number of applications may be good candidates for 5G. However, in the same way that nobody predicted an application such as ride hailing (e.g., Lyft, Uber) when operators first deployed 4G some ten years ago, many applications for 5G remain to be invented. Many of these will have huge economic and societal impact. Until then, expected applications likely to use 5G include:

- ❑ **Increased fixed-mobile substitution.** With much higher network capacity, operators will be able to offer plans with higher data allowances, making it feasible for a greater percentage of users to have mobile broadband as their only data plan.
- ❑ **Fixed wireless access.** 5G will provide a viable alternative to wireline broadband networks. See discussion above.

---

<sup>26</sup> Per 3GPP TR 38.913 (V14.2.0, Mar. 2017), 0.5 msec for DL and 0.5 msec for UL for URLLC and 4 msec for UL and 4 msec for DL for eMBB.

<sup>27</sup> For example, see Ericsson, *An overview of the IMT-2020 Evaluations, R1-1806431*, May 2018. Intel, *Initial Results for IMT-2020 Self-Evaluation, R1-1804758*, May 2018. Nokia, *IMT-2020 self evaluation: Initial UP latency analysis, R1-1807288*. Nokia, *Spectral Efficiency Results for the IMT-2020 Self-Evaluation, R1-1807284*, May 2018. These 3GPP contributions are available at <https://portal.3gpp.org/ngppapp/TdocList.aspx?meetingId=18784>.

- ❑ **Synergistic AI.** AI will find its way into countless new communications-oriented applications, including personal assistants, health, education, transportation, and professional occupations.
- ❑ **Augmented reality and virtual reality.** Higher throughputs, lower latency, and edge computing will make AR and VR over 5G mainstream. See further discussion below in this section.
- ❑ **Ultra-high definition video.** Extremely high-resolution video streaming and downloads, including 4K, 8K, and 3D, will be possible over 5G, although such usage may only be feasible on a wide scale in higher capacity mmWave bands.
- ❑ **Live TV at scale.** With high capacity and multicast/broadcast capabilities, TV operators will be able to broadcast TV channels over 5G.
- ❑ **Healthcare.** 5G will support applications such as health monitoring through wearable/implanted devices, telemedicine, and robotic or remote surgery.
- ❑ **Cloud gaming.** High throughputs, low latency, and edge computing will enable games to be hosted in the cloud.<sup>28</sup>
- ❑ **Automotive.** Sensors in roadways, communications between infrastructure and cars, and communications between cars, will make driving safer and more efficient, and will also support autonomous cars.<sup>29</sup> Other automotive applications, some already possible with 4G, include vehicular internet, augmented navigation, and infotainment.
- ❑ **Other transportation.** 5G will support additional transportation applications, such as connected trucks, connected bus-stops, parking information systems, and fleet monitoring.
- ❑ **Drones.** High bandwidth will allow video streaming from drones. High reliability with low latency will safely control them.
- ❑ **Video surveillance.** Video cameras coupled with AI will become ubiquitous, improving safety and supporting many IoT applications.
- ❑ **Education.** Many forms of connected education will be enhanced, including high-resolution, telepresence-based distance learning. AR/VR will also play a role.
- ❑ **Smart cities, smart neighborhoods, and smart homes.** 5G will support high densities of sensors, surveillance, smart infrastructure, smart lighting, and safety enhancements.
- ❑ **Wearable computing.** Low-power operation and simplified, low-cost devices will enable 5G connectivity with long battery life for health and fitness.

---

<sup>28</sup> For example, see Fierce Wireless, "Google's streaming game platform Stadia has implications for 5G," Mar. 25, 2019. <https://www.fiercewireless.com/wireless/google-s-new-streaming-game-stadia-has-implications-for-5g>.

<sup>29</sup> See the section below, "Cellular V2X Communications," for details.

- ❑ **Monitoring of infrastructure.** Low-latency and long battery life sensors will allow rapid responses to events involving water, energy, and other critical utilities.
- ❑ **Manufacturing and other industrial applications.** High reliability, precision timing, low latency, and private-network options in 5G will significantly expand use in industry, including factory automation and real-time monitoring of plants and processes. See further discussion below in this section.
- ❑ **Agriculture.** Low-cost sensors, precise positioning, and asset tracking will improve efficiency and costs.

Some of these applications are already being addressed by 4G, but 5G's lower costs, higher throughputs, high reliability, and lower latency will hasten realization of their potential.

With respect to VR and AR, the evolution of edge computing, the high-bandwidth and low-latency in 5G, and increasingly capable wearable devices will provide the critical mass over the next five-year period for the proliferation and growth of VR and AR. Figure 12 explains the extended reality (XR), VR, and AR concepts.

**Figure 12: VR, AR, Mixed, and Extended<sup>30</sup>**

Extended reality (XR) is a term referring to all real-and-virtual combined environments and human-machine interactions generated by computer technology and wearables. Examples: flying drones, underwater exploration.



**Mixed Reality:** Mixed reality (MR), sometimes referred to as hybrid reality, is the merging of real and virtual worlds to produce new environments and visualizations where physical and digital objects co-exist and interact in real time. Examples: entertainment industry.



**Virtual reality (VR)** is an immersive multimedia or computer simulated environment which allows one to interact with it. Examples: complete immersive gaming, virtual aviation training, medical/ surgical training, mental treatment.



**Augmented reality (AR)** is a view of a real-world environment whose elements are supplemented and enhanced by computer-generated sensory input such as sound, video, or graphics. Examples: tourism, retail-furniture visualizers, clothes visualizer.

<sup>30</sup> Cisco contribution. See associated report, Cisco Visual Networking Index: Global Mobile Data Traffic Forecast Update, 2017–2022, Feb. 2019.



Cisco projects that globally, augmented and virtual reality traffic will grow nearly twelvefold from twenty-two petabytes per month in 2017 to 254 petabytes per month in 2022.<sup>31</sup>

As for industrial IoT, usage will increase through 5G capabilities, as well as other technology developments:

- ❑ 5G mission-critical-communications capability based on URLLC.
- ❑ 5G ability to support up to one million devices per sq. km.
- ❑ 5G network slicing addressing precise quality-of-service (QoS) requirements.
- ❑ High accuracy 5G positioning information.
- ❑ 5G New Radio NR-U (New Radio Unlicensed) operation facilitating private network deployment.
- ❑ 5G support for time-sensitive networking.
- ❑ Private edge clouds that provide scalable, secure local computing.
- ❑ Machine learning (AI) for monitoring, prediction, and optimization.
- ❑ Supporting organizations, such as the 5G Alliance for Connected Industries and Automation.

Industry has gone through a number of stages: industrial mechanization the first stage, electrification the second, and digitalization the third. 5G connectivity enables what some now refer to as "Industry 4.0."<sup>32</sup>

## **5G Frequency Use**

Whereas previous generations of cellular technology used low bands (sub 1 GHz) for coverage and mid-bands for capacity, Figure 13 shows how 5G will use low bands for coverage, mid-band frequencies for a blend of coverage and capacity, and mmWave bands for extremely high capacity but with restricted coverage.

The cornerstone of 5G frequency use is flexibility. 5G will:

- ❑ Operate in a broad range of frequencies (to 52.6 GHz in Release 15/16 and to 71 GHz in Release 17), far greater than previous generations of technology.
- ❑ Support a wide range of radio channel bandwidths, up to 100 Mhz sub 6 GHz and up to 400 MHz in mmWave, coupled with the ability to aggregate radio channels for even higher bandwidths.
- ❑ Operate in either Time Division Duplex (TDD) or Frequency Division Duplex (FDD) modes in sub-6 GHz bands and in TDD mode in mmWave bands.

---

<sup>31</sup> Ibid.

<sup>32</sup> For example, see Qualcomm webinar, "The Role of 5G in Private Networks for Industrial IoT," May 2019.

- Support both licensed and unlicensed spectrum.

**Figure 13: Three-Tier Spectrum Usage for 5G**

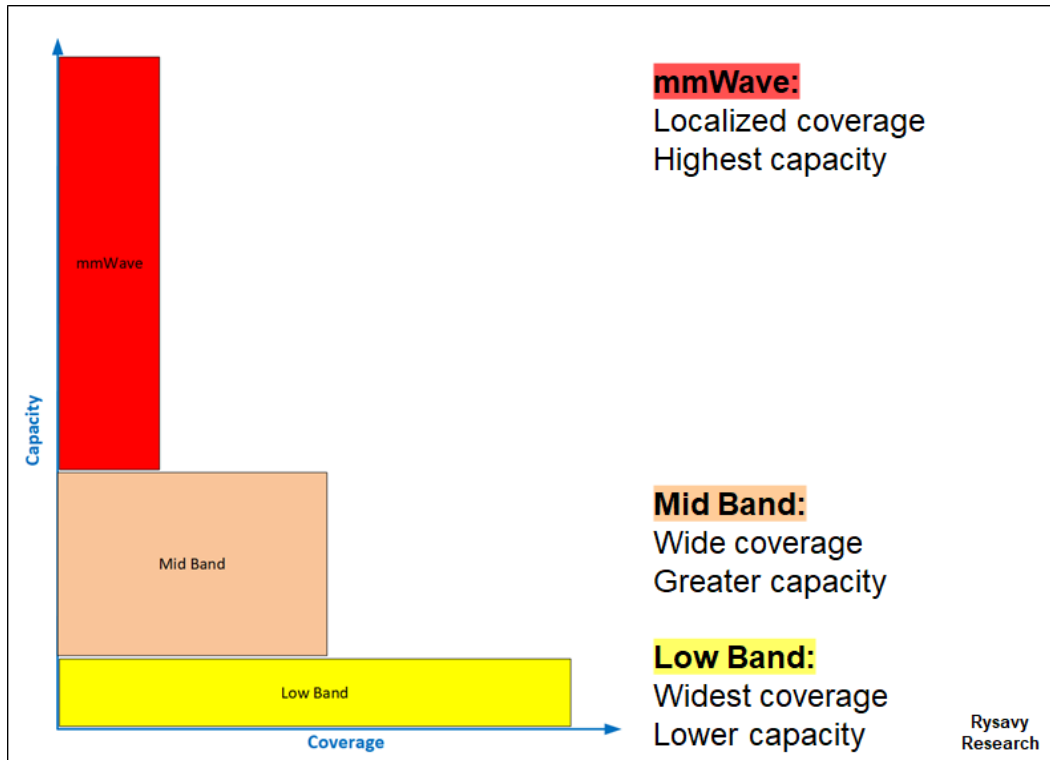

Mid-band frequencies in particular are a sweet spot for today's 5G technology; mid-band frequencies allow massive MIMO for significant performance and capacity gains while still facilitating deployment through collocation on existing urban cell sites. A 64T64R antenna configuration can triple the capacity of a cell relative to 4X4 MIMO.<sup>33</sup> A vendor reports 1.6 Gbps peak throughputs using NR with 64T64R antennas and a 100 MHz radio channel.<sup>34</sup> Relative to mmWave, mid-band frequencies also have better in-building penetration.

A core 5G design objective has been to leverage existing technology investments in LTE while exploiting new spectrum and technology capabilities. 5G design emphasizes ways to combine existing 4G LTE networks with capabilities provided by 5G. One potential approach is to use LTE in existing frequency bands and the 5G NR in new bands, such as mmWave, as shown in Figure 14. An operator can pursue this approach using an LTE core network (nonstandalone architecture) with LTE providing base coverage and NR providing augmented capacity and performance in select areas.

<sup>33</sup> Commscope, *4G and 5G Capacity solutions - comparative study*, July 2019. <https://www.commscope.com/globalassets/digizuite/2154-capacity-solutions-comparative-study-wp-113400-en.pdf?r=1>.

<sup>34</sup> Light Reading webinar, "Huawei's View: State-of-the-Art in 5G RAN Equipment," Dec. 18, 2019. [https://www.lightreading.com/webinar.asp?webinar\\_id=1540](https://www.lightreading.com/webinar.asp?webinar_id=1540).

See also Fierce Wireless, "Nokia touts 5G C-band trial in Dallas," Jun. 19, 2020. <https://www.fiercewireless.com/tech/nokia-touts-5g-c-band-trial-dallas>.

**Figure 14: 5G Combining of LTE and New Radio Technologies**

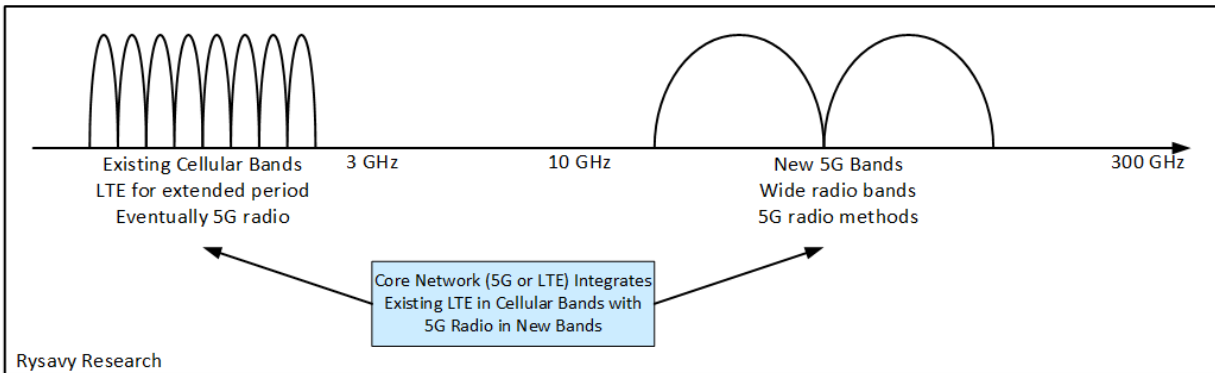

5G NR, however, will operate in all frequencies, and just as 2G and 3G spectrum has been re-farmed for LTE, so will existing cellular bands will be re-farmed for 5G. In addition, with Dynamic Spectrum Sharing (DSS), the same radio channel can support both LTE and 5G, facilitating the rollout of 5G in existing cellular bands. See the section “Dynamic Spectrum Sharing” for more details about this important capability.

As shown in Figure 15, higher frequency bands in 5G provide capacity with smaller cells, and lower bands can provide coverage with larger cells. This is similar to the approach taken in 4G.

**Figure 15: Characteristics of Different Bands<sup>35</sup>**

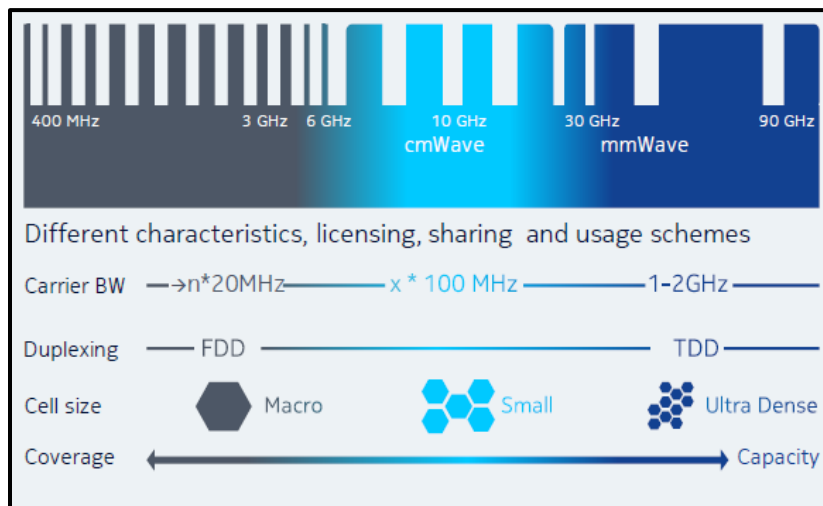

One important aspect of 5G is its ability to use mmWave spectrum from 24 to 100 GHz<sup>36</sup> and eventually higher. This differs from previous cellular technology deployments in which lower frequencies had significantly better propagation characteristics than higher frequencies. 5G can address such a wide range of spectrum thanks to massive MIMO,

<sup>35</sup> Nokia, “Vision & Priorities for Next Generation Radio Technology,” 3GPP RAN workshop on 5G, Sep. 17-18, 2015.

<sup>36</sup> Exact frequencies supported depend on release. Release 15 and 16 operate to 52.6 GHz, with higher frequencies anticipated for Release 17.

which exploits the fact that at higher frequencies, wavelengths are shorter, so antenna elements can be closer to one another, allowing for more antenna elements.<sup>37</sup> As shown in Figure 16, the greater number of antenna elements in higher bands enables more tightly focused beams that can compensate for the otherwise poorer propagation of the radio signal.<sup>38</sup>

**Figure 16: Higher-Order MIMO Compensation for Poorer Propagation**

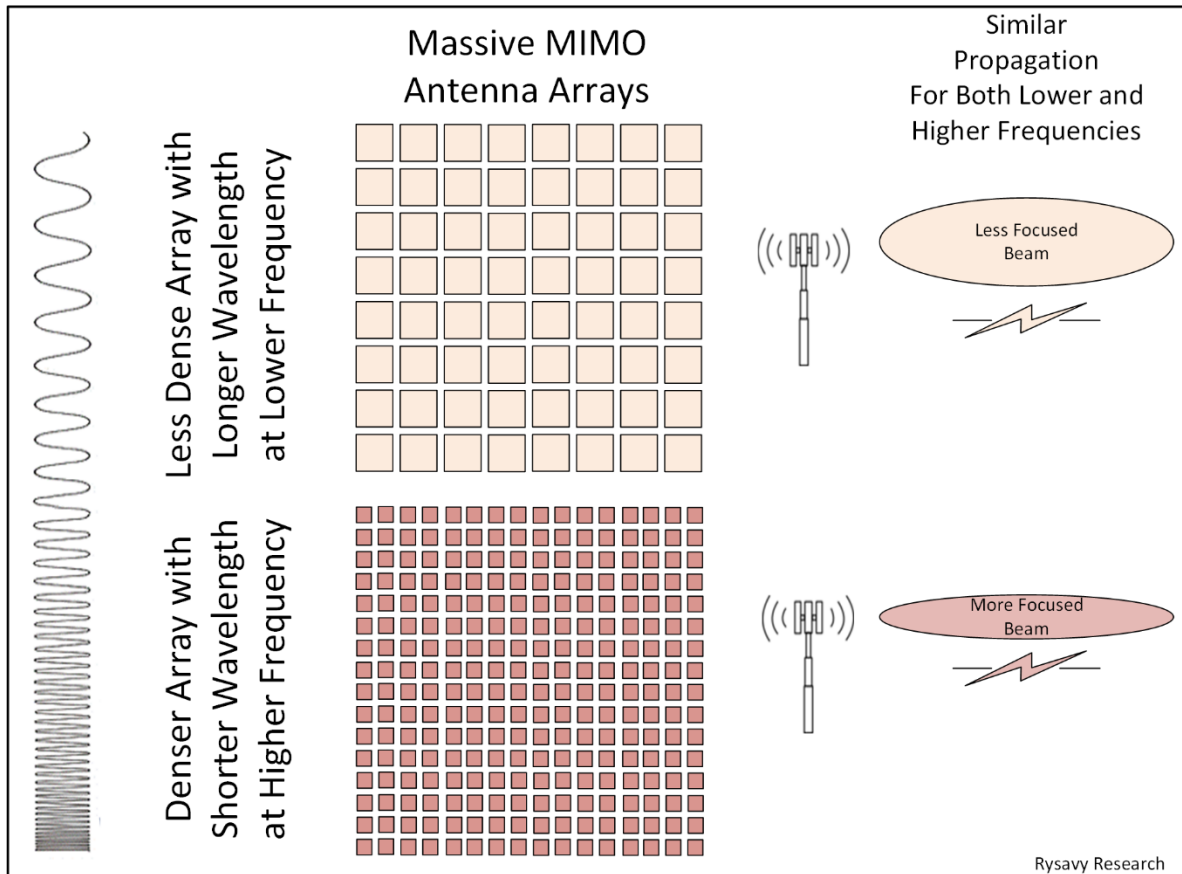

The consequence of this ability is that the industry will be able to rapidly deploy 5G in a wide range of frequencies. For this reason, the FCC is now evaluating future allocations of spectrum all the way to 275 GHz with provisions for experimental licensing up to 3000 GHz.<sup>39</sup> With previous licensed cellular spectrum reaching only 2.5 GHz, current developments are reaching for spectrum that spans a range two orders of magnitude greater. The outcomes in new services and applications will be dramatic.

Use of higher frequencies, such as above 6 GHz, represents one of the greatest opportunities for higher throughputs and higher capacity. But these higher frequencies,

<sup>37</sup> Note that massive MIMO is also effective at mid-band frequencies.

<sup>38</sup> For a detailed examination of the antenna systems used in 5G, refer to the 5G Americas paper, *Advanced Antenna Systems for 5G*, Aug. 2019. <https://www.5gamericas.org/white-papers/>.

<sup>39</sup> FCC, *Notice of Proposed Rulemaking and Order, Spectrum Horizons*, ET Docket No. 18-21, Feb. 2018.

especially mmWave frequencies (24 GHz and higher), are suitable only over short distances. The combination of lower and higher frequencies is therefore crucial for 5G operation.

Compared with lower frequencies, mmWave frequencies suffer from poorer penetration and propagation characteristics, even in line-of-sight conditions, because the comparatively smaller aperture area of the receiver's antenna requires some form of beamforming at the transmit side and potentially even at the receive side. Fortunately, the smaller form factors of mmWave antennas allow for dense packing of antenna arrays.

More typically, mmWave cells will employ shorter ranges of 50 to 200 meters. Extreme densification is another way that 5G networks will augment capacity. 3G networks reached densities of four to five base stations per sq. km, 4G networks eight to ten, but 5G networks could reach densities of more than 100 sites per sq. km. Either wireless connections or fiber will provide backhaul. Figure 17 shows how such an approach employs beamforming and beam tracking when using mmWave bands in the small cells.

**Figure 17: 5G Architecture for Low-Band/High-Band Integration**

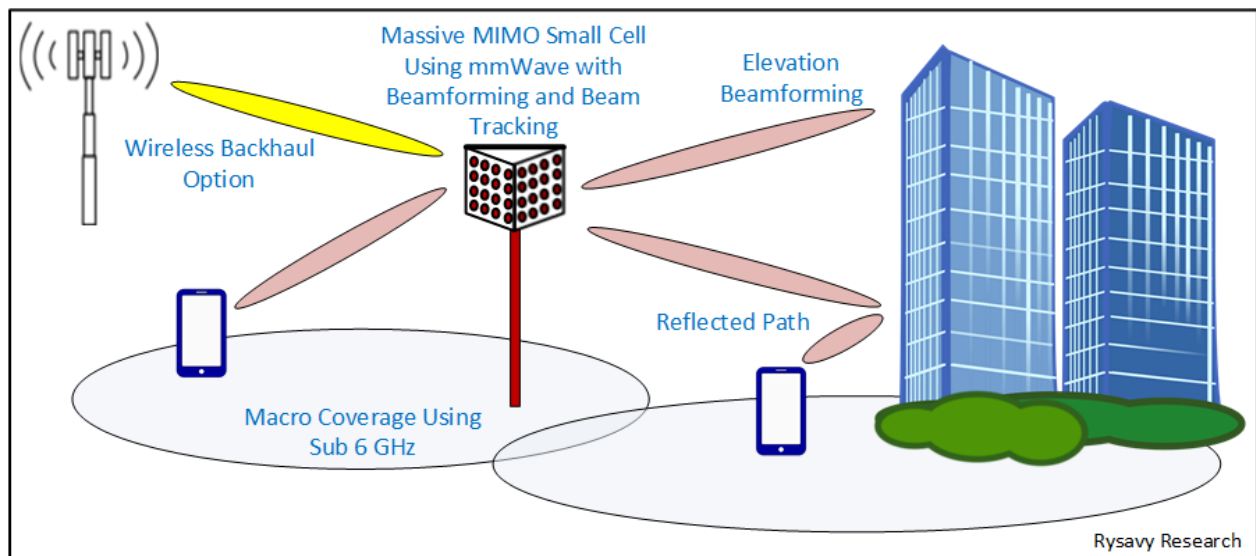

In combination, the various methods in 5G can provide users in mmWave band hotspot coverage at least a 100-fold increase in throughput over LTE, achieved by:

- ❑ Five to tenfold gains due to a high number of small cells, each with fewer users.
- ❑ Tenfold gains from access to much larger amounts of spectrum.
- ❑ Threefold gains or more from improved spectral efficiency.

This huge increase in capacity, combined with Gbps performance, that will allow 5G to compete with wireline networks.<sup>40</sup>

<sup>40</sup> For a further discussion of 5G capacity and ability to compete with wireline networks, refer to Rysavy Research, *5G Network Planning—Capacity, Performance, Wireline Competitiveness*, 2019. <https://rysav.com/broadband-reports/>.

## 5G Schedule

Figure 18 shows the current schedule for 5G development and deployment.<sup>41</sup> 3GPP standardized the first version of 5G in Release 15 and completed the non-standalone (NSA) version of 5G in March 2018, which implemented architecture option 3. Architecture option 3 supports LTE and NR access to an LTE core network, referred to as Evolved Packet Core (EPC). See the section below, “5G Architecture” for a discussion of architecture options. Normally, the industry takes approximately eighteen to twenty-four months after standards completion to begin deploying networks and devices, but in the case of 5G NSA, operators compressed the deployment timeframe, with many deployments beginning in 2019.

3GPP issued another version of the Release 15 specification in September 2018 with support for architecture option 2 (NR only radio access to a 5G NGC), the standalone (SA) version. 3GPP then issued a final version of the Release 15 specifications in June 2019, with support for architecture options 4 and 7 (LTE and NR radio access to a 5G NGC) and option 5 (LTE-only radio access to a 5G NGC). Options 4, 5, and 7 provide alternative deployment paths for migration from NSA to SA. For example, one possible migration path is Option 3 (NSA with LTE core) to Option 4 (NSA with 5G NGC) to Option 2 (SA).

Because the final version of Release 15 provides optional migration paths from Option 3 to Option 2, Release 15 deployments based on the different options may not be sequential, as suggested by the figure.

Release 16, which is the second phase of 5G, was completed mid-2020, and Release 16 deployments will occur in the late 2021 to early 2022 timeframe. In 2020, 3GPP began work on Release 17 with scheduled completion in 2021.

**Figure 18: 5G Timeline**

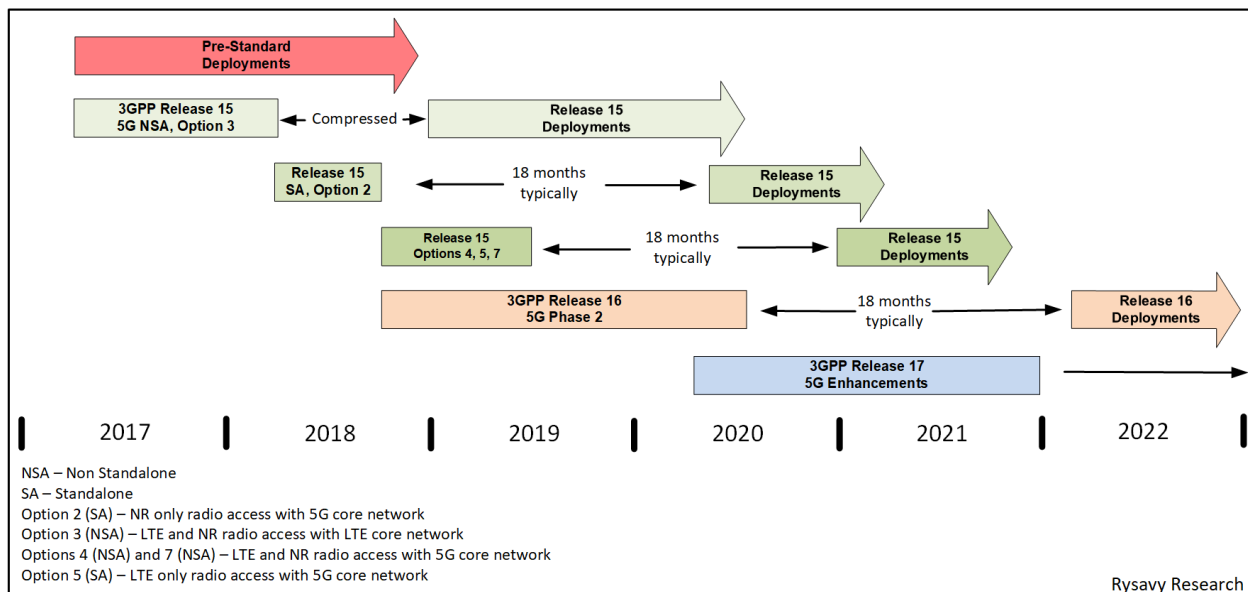

<sup>41</sup> Note that schedules shown are based on Abstract Syntax Notation One (ASN.1) completion, meaning the specifications are fully complete. Stage 3 completion of specifications is when features are frozen and precedes ASN.1 completion by a typical three months.

## 5G Device Availability

Initial devices<sup>42</sup> included routers that had a 5G radio and used Wi-Fi for local Hotspot capability, and USB modems. 5G smartphones, first available in 2019, have a variety of choices available in 2020. Vendors are also developing laptops with integrated 5G capability.

Figure 19 shows a timeline of device availability based on bands supported and whether networks are standalone (5G core network) or non-standalone (LTE core network).

**Figure 19: 5G Device Timeline<sup>43</sup>**

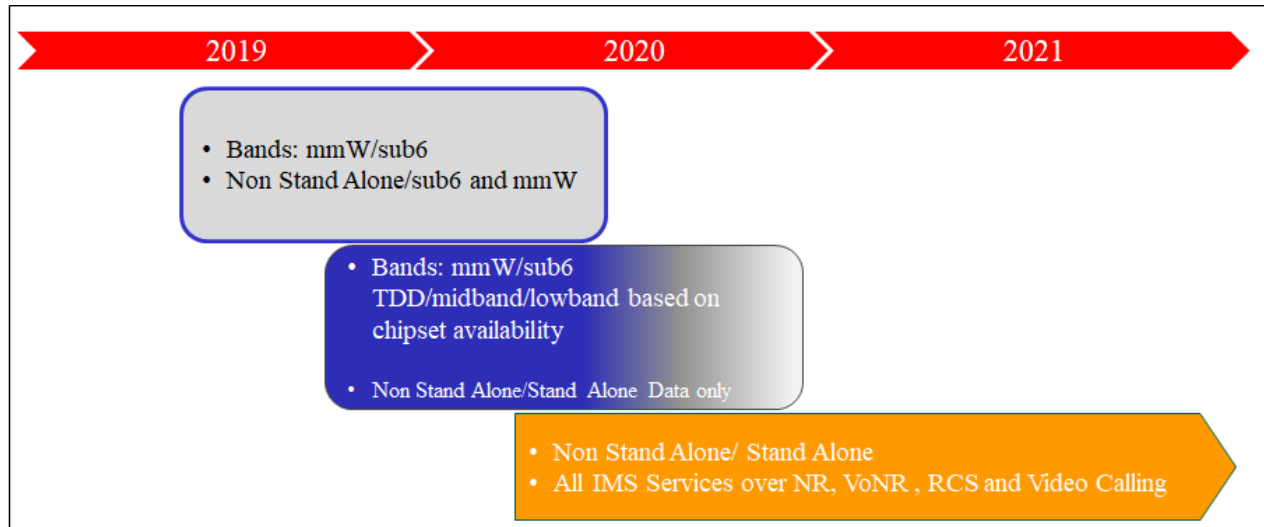

## 5G Phase One (Release 15)

The capabilities of the New Radio and Next Generation Core in 5G, based on Release 15 specifications, include:

- ❑ **Frequency Agility.** Ability to operate in any frequency band, including low, mid, and high bands.
- ❑ **Dual Connectivity.** Network can support both LTE and 5G NR, including dual connectivity with which devices can have simultaneous connections to LTE and NR.
- ❑ **Virtualization.** Operators are building their 5G networks using network function virtualization and software defined networking. See the sections “Virtualization and Cloud Native” and “O-RAN” for more detail.
- ❑ **High Data Rates.** 5 Gbps peak downlink throughput in initial releases, increasing to 50 Gbps in subsequent versions.

<sup>42</sup> Ibid.

<sup>43</sup> 5G Americas member contribution.

- ❑ **OFDMA and SC-FDMA.** OFDMA in downlink and uplink, with optional Single Carrier Frequency Division Multiple Access (SC-FDMA) for uplink.<sup>44</sup>
- ❑ **Initial URLLC Support.** Physical layer frame structure and numerology support with radio approach are defined in Release 15.
- ❑ **Massive MIMO and Beamforming.** Data, control, and broadcast channels are all beamformed.
- ❑ **FDD and TDD.** Ability to support either FDD or TDD modes for sub 6 GHz radio bands.
- ❑ **Scalable Radio.** Numerologies of  $2^N \times 15$  kHz for subcarrier spacing up to 120 kHz or 240 kHz.<sup>45</sup> This scalable OFDM approach, depicted in Figure 20, supports both narrow radio channels (for example, 1 MHz), or wide ones (up to 100 MHz per component carrier sub 6 GHz and up to 400 MHz in higher frequencies).
- ❑ **Carrier Aggregation.** Carrier aggregation for up to 16 NR carriers.
- ❑ **High Radio Bandwidth.** Aggregation of up to 16 component carriers.
- ❑ **Efficient Coding.** Error correction through low-density parity codes (LDPC) for data transmission, which are computationally more efficient than LTE turbo codes at higher data rates. Control channels use polar codes.
- ❑ **Cloud RAN.** Standards-based cloud RAN support specifies a split between the Packet Data Convergence Protocol (PDCP) and Radio Link Control (RLC) protocol layers. See the sections “Virtualization and Cloud Native” and “O-RAN” for more details.
- ❑ **Efficient Slot Structure.** Self-contained integrated subframes (slots) that combine scheduling, data, and acknowledgement. Benefits include fast and flexible TDD switching, lower latency, and efficient massive MIMO.
- ❑ **Scalable Time Intervals.** Scalable transmission time intervals with short time intervals for low latency and longer time intervals for higher spectral efficiency.
- ❑ **Futureproofing.** Futureproofing by providing a flexible radio framework that has forward compatibility to support future, currently unknown services, such as URLLC to be specified in Release 16 and unlicensed/shared spectrum.
- ❑ **Security.** A comprehensive security architecture, including confidentiality and integrity of user data and signaling, subscriber privacy, a bi-directional authentication framework, and key management.<sup>46</sup>

---

<sup>44</sup> SC-FDMA limited to Rank 1 and just for propagation-limited scenarios.

<sup>45</sup> 240 kHz spacing is for sync, not data.

<sup>46</sup> For details, see 5G Americas, *Security Considerations for the 5G Era*, Jul. 2020.  
<https://www.5gamericas.org/security-considerations-for-the-5g-era/>.

See also 3GPP, *Security architecture and procedures for 5G System*, TS 33.501.  
<https://portal.3gpp.org/desktopmodules/Specifications/SpecificationDetails.aspx?specificationId=3169>



- ❑ **Quality of Service.** QoS support using a new model and implementation via network slicing.
- ❑ **Network Slicing.** See the section "Network Slicing" for more details.
- ❑ **Dynamic Spectrum Sharing.** Dynamic coexistence with LTE in the same radio channels. See the section "Dynamic Spectrum Sharing" for more details.
- ❑ **Edge Computing.** Flexible support for edge computing with 5G core, including User Plane Function (UPF) selection. See the section "Edge Computing" for more details.
- ❑ **Service Based Architecture.** Protocol support for the service-based architecture (SBA), network slicing, Policy and Charging Control (PCC) function, and mobility and session management. See the appendix section "5G – Architecture in More Detail" for further information.
- ❑ **IMS Support.** Support for IMS services, including IMS emergency services over 5G. See the appendix section "IP Multimedia Subsystem" for more detail.
- ❑ **Future Railway Mobile Communication System (FRMCS).**<sup>47</sup>
- ❑ **Regulatory Aspects including Lawful Intercept.**

**Figure 20: Example of 5G Numerology**

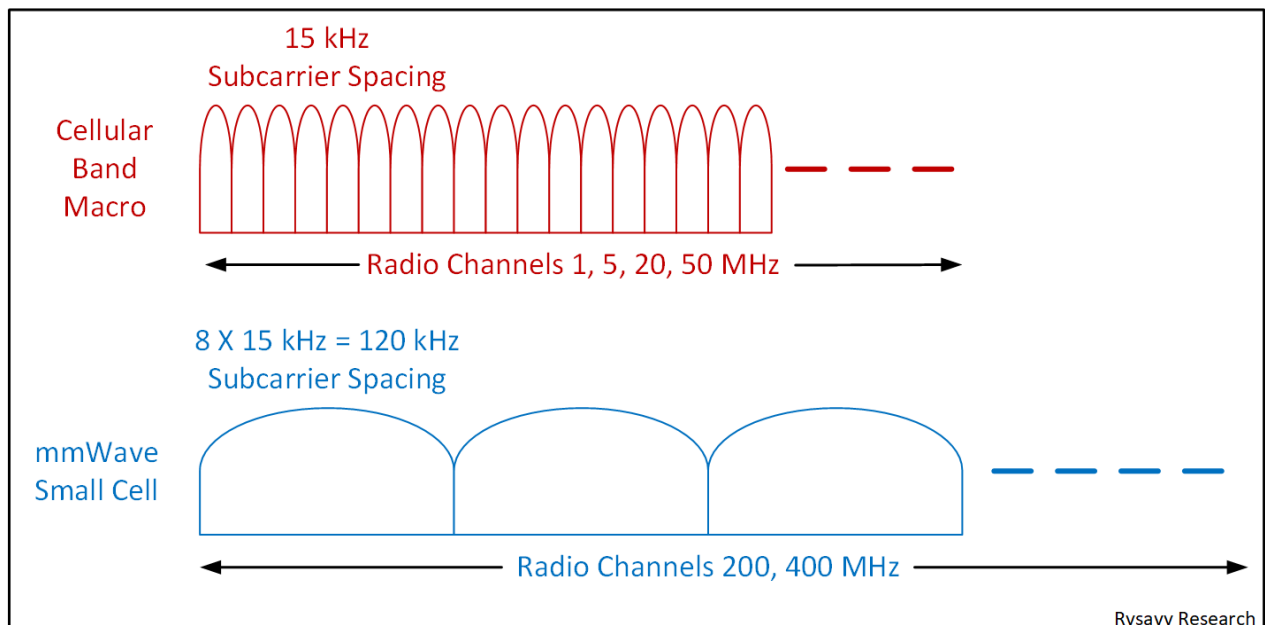

Operators globally have expressed interest in deploying NR in a wide variety of bands, including current cellular bands, 3.5 GHz, and mmWave bands.

<sup>47</sup> For further details, see UIC, "Future Railway Mobile Communication System," <https://uic.org/rail-system/frmcs/>.

## 5G Phase Two (Release 16)

Release 16 adds support for:

- ❑ **URLLC.** Based on methods such as configured-grant transmissions and protocol data unit (PDU) duplication, enhanced error correction, and enhanced scheduling. See the section "Internet of Things" for more details.
- ❑ **NR-U.** New Radio-Unlicensed for unlicensed spectrum operation in 5 GHz and 6 GHz bands. See the section "Unlicensed Spectrum Integration" for more details.
- ❑ **Integrated Access and Backhaul.** Uses the 5G radio signal for a backhaul connection. See the section "Integrated Access and Backhaul" for more information.
- ❑ **Industrial IoT.** Features include URLLC and time-sensitive communications (with deterministic communications and/or isochronous communications with high reliability and availability). Also includes support for non-public networks, 5G LAN-type services, and positioning. See the section "Internet of Things and Industrial IoT" for more detail.
- ❑ **C-V2X.** NR-based C-V2X, including side-link communications (direct vehicle-to-everything communication). See the section "Cellular V2X Communications" for more detail.
- ❑ **Positioning.** Commercial and regulatory uses. Location using a variety of approaches. See the section "5G NR Cellular Positioning" below and the appendix section "5G NR Positioning Methods in Detail" for further detail.
- ❑ **Non-Public Networks.** Support for both standalone private networks and ones integrated with public networks.
- ❑ **Network Automation.** Network data collection and analytics via the Network Data Analytics Function (NWDAF) to support network slicing management and facilitate AI integration within the network.
- ❑ **Two-step Random Access Procedure.** More efficient uplink operation.
- ❑ **Convergence.** Wireless and wireline convergence for the 5G system architecture.
- ❑ **Mission Critical Support.** Includes public warnings, railways, and maritime.
- ❑ **Cross link interference and remote interference management.**
- ❑ **Service Enabler Architecture Layer for Verticals (SEAL).** Application-level functional architecture for verticals, including V2X and mission-critical services. Services address group management, configuration management, location management, identity management, key management, and network resource management.<sup>48</sup>

---

<sup>48</sup> Rohde & Schwarz, *5G Evolution – On the Path to 6G*, 2019.  
[https://www.mobilewirelesstesting.com/wp-content/uploads/2019/10/5G-evolution-on-the-path-to-6G- wp\\_en\\_3608-3326-52\\_v0100.pdf](https://www.mobilewirelesstesting.com/wp-content/uploads/2019/10/5G-evolution-on-the-path-to-6G- wp_en_3608-3326-52_v0100.pdf).

- ❑ **FRMCS Phase 2.**
- ❑ **Enhancements.** Enhancement of features introduced in Release 15, including network slicing, MIMO, dual-connectivity, carrier aggregation, Common API Framework (eCAPIF), security (including IOT, network slicing, mission critical, and false base stations), efficiency, signaling, security, and reduced UE power consumption.
- ❑ **Study Items.** Operation above 52.6 GHz, non-orthogonal multiple access, and non-terrestrial networks (NTN).

## 5G Release 17

Just as LTE continued to be enhanced from its first release in Release 8 through today's Release 15 version of LTE, 5G will also continue to be improved during the 2020s. 3GPP agreed-upon capabilities for Release 17 include:<sup>49</sup>

- ❑ **NR-Light.** Low complexity and low power, with reduced capability, for devices such wearables, IoT, industrial sensors, and video surveillance. Performance falls between LTE Narrowband IoT/LTE-M and full NR.
- ❑ **NR operation in 52.6 - 71 GHz.** Unlicensed band support in this frequency range expected in Release 18.
- ❑ **Multiple SIMs.** Multiple SIMs in UE.
- ❑ **NR Multicast and Broadcast.** Targets V2X, public safety, IPTV, group communication IoT, and software delivery over wireless.
- ❑ **Non-terrestrial networks.** Includes low earth orbit (LEO) and geostationary satellites, as well as High Altitude Platform Stations (HAPS) such as balloons and airplanes.<sup>50</sup> Use cases include global IoT, coverage, public safety, and transportation.
- ❑ **ONAP.** Integration of Open Network Automation Platform (ONAP) and 3GPP 5G management framework.
- ❑ **Network Slicing enhancements.**
- ❑ **Edge Computing in 5G Core.**
- ❑ **Network Automation Phase 2.**
- ❑ **Enhancements.** Enhancements of 5G features specified in earlier releases, including industrial IoT and URLLC (to support wider use cases), efficient transmission of small amounts of data, sidelink (device-to-device communications for V2X, commercial, and critical communications), MIMO, V2X, NR coverage, IAB,

---

<sup>49</sup> 3GPP, "Release 17," <https://www.3gpp.org/release-17>, viewed Apr. 7, 2020. See also 5G Americas, *The 5G Evolution, 3GPP Releases 16-17*, Jan. 2020.

<sup>50</sup> ITU, "HAPS – High-altitude platform systems." <https://www.itu.int/en/mediacentre/backgrounders/Pages/High-altitude-platform-systems.aspx>.

unlicensed operation, high-accuracy positioning, dynamic spectrum sharing, SON, dual-connectivity, and power saving.

- ❑ **Study Items.** Includes architecture for edge applications, application layer support for unmanned aerial systems, application layer support for factories of the future, and application layer support for V2X services.<sup>51</sup>

Refer to the appendix section “3GPP Releases to Release 14” for a summary of features in prior specification releases.

## **5G Architecture**

Release 15 also defines initial core network capabilities (5G Next Generation Core) that support QoS and network slicing. Many operators will virtualize their 5G core networks, just as they have for LTE, but such virtualization is outside the scope of 3GPP specifications.

3GPP specified the first phase of 5G in Release 15. So that operators can deploy 5G sooner, 3GPP divided Release 15 into three sets of specifications. The first set of specifications defined how a 5G RAN can integrate with an LTE network in what 3GPP calls a non-standalone option. In this earliest version (architecture option 3), NR relies on an existing LTE network, both in the RAN and in the core.

The complete Release 15 specifications also define a 5G-NGC. Figure 21 shows some of the architecture options. Options 3, 4, and 7 are non-standalone options, and options 1, 2, and 5 are standalone.

---

<sup>51</sup> 3GPP, “3GPP SA6 accelerates work on new verticals!” Jun. 17, 2019. [https://www.3gpp.org/news-events/2045-sa6\\_verticals](https://www.3gpp.org/news-events/2045-sa6_verticals), accessed May 21, 2020.

**Figure 21: Release 15 Non-Standalone and Standalone Options**

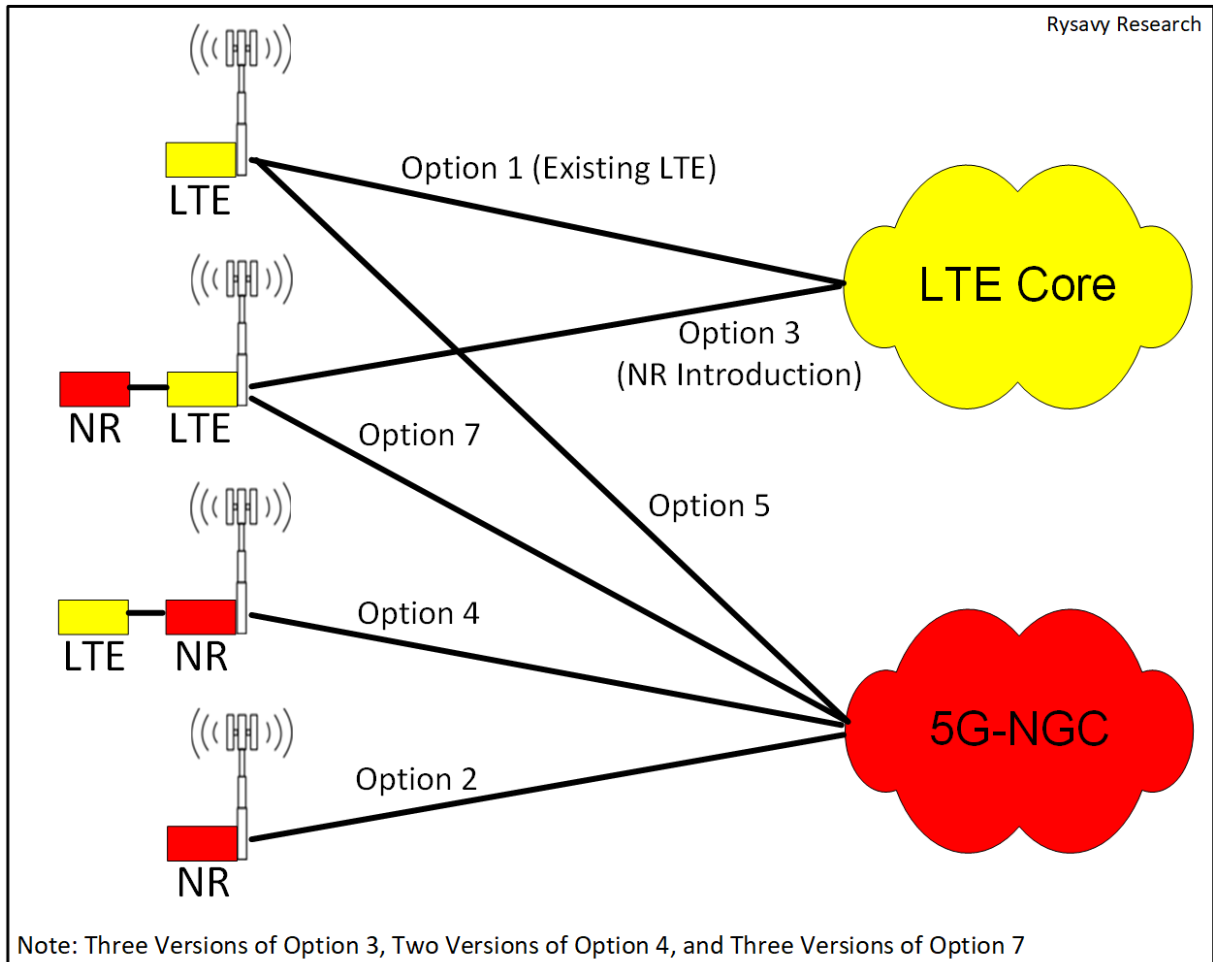

Option 3 is a common initial architecture for deploying 5G because it allows the introduction of NR using an existing LTE core network. However, Option 2, a standalone configuration with NR radio and 5G core, represents the end-game architecture. Option 2 provides the most powerful network configuration with the greatest network simplicity.

The benefits of standalone architecture are as follows:

- ❑ Enables all 5G use cases to be addressed.
- ❑ Supports industrial IoT through lower end-to-end latency and higher number of devices.
- ❑ Supports network slicing with which operators can fine tune network QoS to address specific business cases.
- ❑ Improves edge computing with a more flexible architecture in which traffic steering to a target User Plane Function (UPF) enables local breakout of data.
- ❑ Combination of edge computing with low latency helps realize V2X/URLCC applications.

- ❑ Improves coverage with carrier aggregation across bands.<sup>52</sup>
- ❑ Reduces up-switching delays that currently occur in handing off from LTE in a lower band to NR in a higher band.<sup>53</sup>
- ❑ Provides faster connection times via a function called Radio Resource Control (RRC) Inactive.
- ❑ Simplifies deployment for private networks where LTE support is not required.

By leveraging virtualization, the standalone architecture employs what is called a Service Based Architecture (SBA). With SBA, every network function can discover services offered by other network functions. SBA incorporates principles of modularity, reusability, and self-containment of network functions. See the appendix section "5G – Architecture in More Detail" for further information.

5G Americas states that it, "believes the benefit of focusing on the currently planned Options (3 and 2) will allow the industry to scale the 5G eco-system . . . The target architecture for the 5G migration is to use SA NR and 5GC as far as possible, even though LTE/EPC will need to remain for a long time to handle legacy devices."<sup>54</sup> GSMA states in its SA Option 2 guidelines, "Compared with Non-Standalone (NSA) Option 3, 5G Standalone (SA) Option 2 network demonstrates advantages in uplink (UL), End-to-End (E2E) latency, edge computing. . ."<sup>55</sup> In the United States, AT&T, Dish Networks, T-Mobile, and Verizon have indicated they will begin deploying standalone 5G, as have Chinese operators.<sup>56</sup>

---

<sup>52</sup> Ericsson, "Carrier aggregation in 5G." <https://www.ericsson.com/en/networks/offerings/5g/carrier-aggregation>.

<sup>53</sup> LightReading, "'Upswitching' From LTE Trips Up 5G Latency In South Korea," Sep. 10, 2019. <https://www.lightreading.com/mobile/5g/upswitching-from-lte-trips-up-5g-latency-in-south-korea/d/d-id/753956>.

<sup>54</sup> 5G Americas, *The 5G Evolution, 3GPP Releases 16-17*, Jan. 2020. <https://www.5gamericas.org/white-papers/>.

<sup>55</sup> GSMA, *5G Implementation Guidelines: SA Option 2*, Feb. 2020. <https://www.gsma.com/futurenetworks/wp-content/uploads/2020/02/5G-SA-Option-2-ImplementationGuideline-v1.2.pdf>.

<sup>56</sup> Light Reading, "AT&T to Begin Standalone 5G Rollout Next Year," Oct. 9 2019. <https://www.lightreading.com/mobile/5g/atandt-to-begin-standalone-5g-rollout-next-year-/d/d-id/754717>.

Fierce Wireless, "Dish selects Fujitsu, Altiostar for 5G radios, Open vRAN," Jun. 30, 2020. <https://www.fiercewireless.com/operators/dish-selects-fujitsu-altiostar-for-5g-radios-open-vran>.

T-Mobile, "T-Mobile Achieves Significant 5G Firsts with Cisco, Ericsson, MediaTek, Nokia, OnePlus and Qualcomm," May 4, 2020. <https://www.t-mobile.com/news/network/tmobile-achieves-significant-5g-firsts>.

Fierce Wireless, "Verizon readies shift to 5G standalone core after successful trial," Jul. 9, 2020. <https://www.fiercewireless.com/tech/verizon-readies-initial-shift-to-5g-standalone-core-after-successful-trial>.

Dynamic spectrum sharing, which enables the same radio channel to carry both LTE and NR signals, will facilitate widespread coverage for NR and hasten the transition to an Option 2 architecture. See the section “Dynamic Spectrum Sharing” for more details.

The Option 2 standalone architecture will be particularly attractive to enterprises for private deployments using CBRS spectrum because it dispenses with the overhead of supporting LTE.

The standalone architecture, however, presents logistical challenges in the medium term. For instance, the architecture requires handset support, a feature lacking in first-generation 5G devices that were developed for Option 3 networks. Also, so long as operators operate LTE networks to support legacy devices and provide coverage, they will need to operate both 5G core and LTE core networks in configurations such as the one shown in Figure 22.

**Figure 22: Combination 5G Core and LTE Core Network<sup>57</sup>**

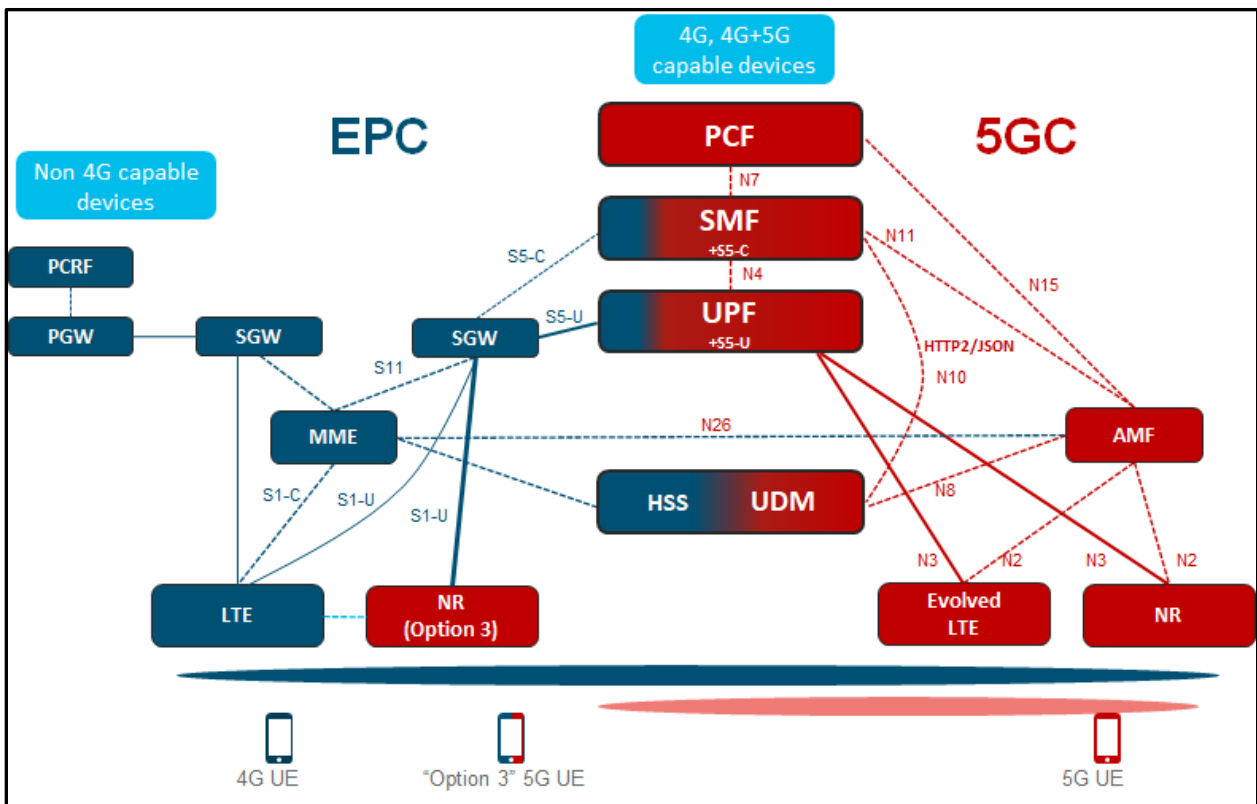

The appendix section “5G Architecture Options” discusses deployment options in greater detail.

Light Reading, “China Targets Standalone 5G in Year of the Rat,” Jan. 23, 2020. <https://www.lightreading.com/asia-pacific/china-targets-standalone-5g-in-year-of-the-rat/d/d-id/757033>.

<sup>57</sup> Cisco contribution. See also Cisco, “Cisco Ultra 5G Packet Core Solution.” [https://www.cisco.com/c/m/en\\_us/network-intelligence/service-provider/digital-transformation/ultra-5g-packet-core-solution.html](https://www.cisco.com/c/m/en_us/network-intelligence/service-provider/digital-transformation/ultra-5g-packet-core-solution.html).

## 5G Performance

Quantifying the 5G user experience is challenging because 5G will be deployed in many configurations, including different bands and with varying width radio channels. In addition, the throughput rates a user experiences depend on signal quality, device capability, and network loading.

Integrating information from a variety of sources, including ITU objectives, simulations, and test results, indicates that 5G NR can:

- ❑ Have more consistent performance over the coverage area.
- ❑ Support peak theoretical rates of 20 Gbps in an 800 MHz radio channel.<sup>58</sup>
- ❑ Support 95% of users experiencing at least 100 Mbps (cell-edge throughput) using a 400 MHz radio channel.<sup>59</sup>
- ❑ Provide peak user-experienced throughputs of greater than 1 Gbps assuming 400 MHz radio channels.<sup>60</sup> See the appendix section on 5G performance for details.
- ❑ Support peak theoretical speeds of more than 4 Gbps.<sup>61</sup>
- ❑ Have 25-30% greater spectral efficiency than LTE assuming same-order MIMO and full implementation of 5G optimizations.<sup>62</sup>
- ❑ Support ten times as many devices.

In testing early 5G networks relative to LTE, Signal Research Group reports that it observed average gains of at least two times with peak performance gains of ten times or higher, depending on the LTE network load and the available LTE and 5G bandwidth, among other factors.<sup>63</sup> The same report indicates measurement of mmWave throughputs in an NFL stadium that frequently exceeded 1 Gbps and peaked at just over 2 Gbps.

Many operators will offer a combination of 4G and 5G using dual connectivity, with which 5G can augment 4G performance. For example, Samsung and SK Telecom in South Korea

---

<sup>58</sup> Ericsson, *An overview of the IMT-2020 Evaluations*, R1-1806431, May 2018. <https://portal.3gpp.org/ngppapp/TdocList.aspx?meetingId=18784>.

<sup>59</sup> Ibid.

<sup>60</sup> 5G Americas member contributions. Higher throughput for 90/10 TDD than 50/50 TDD. Higher throughput for line of sight than non-line of sight.

<sup>61</sup> Samsung, "Samsung Demonstrates the Full Potential of 5G mmWave with Speeds of 8.5Gbps Across Multiple Devices," Apr. 16, 2020. <https://news.samsung.com/us/samsung-5g-mmwave-speeds-8-5gbps-multiple-devices-demonstrates-full-potential/>.

Fierce Wireless, "Nokia tests clock 4.7 Gbps 5G speed in Dallas," May 20, 2020. <https://www.fiercewireless.com/5g/nokia-tests-clock-4-7-gbps-5g-speed-dallas>.

<sup>62</sup> Nokia presentation, "5G New Radio (NR) Interface for Sub 6 GHz & mmWave Bands," IEEE ICC – 2018, May 22, 2018.

<sup>63</sup> Signal Research Group, *A Global Perspective of 5N Network Performance*, Oct. 2019. <https://signalsresearch.com/issue/a-global-perspective-of-5g-network-performance/>.



demonstrated a peak rate of 2.65 Gbps by combining 1.5 Gbps of 5G (100 MHz at 3.5 GHz) with 1.15 Gbps of 4G (65 MHz at 1.8 GHz, 2.1 GHz, and 2.6 GHz).<sup>64</sup>

Just as LTE throughputs have increased significantly over this decade, 5G performance will continue improving over the next ten years, as shown in Figure 23.

**Figure 23: Global Mobile Average Speeds by Network Type<sup>65</sup>**

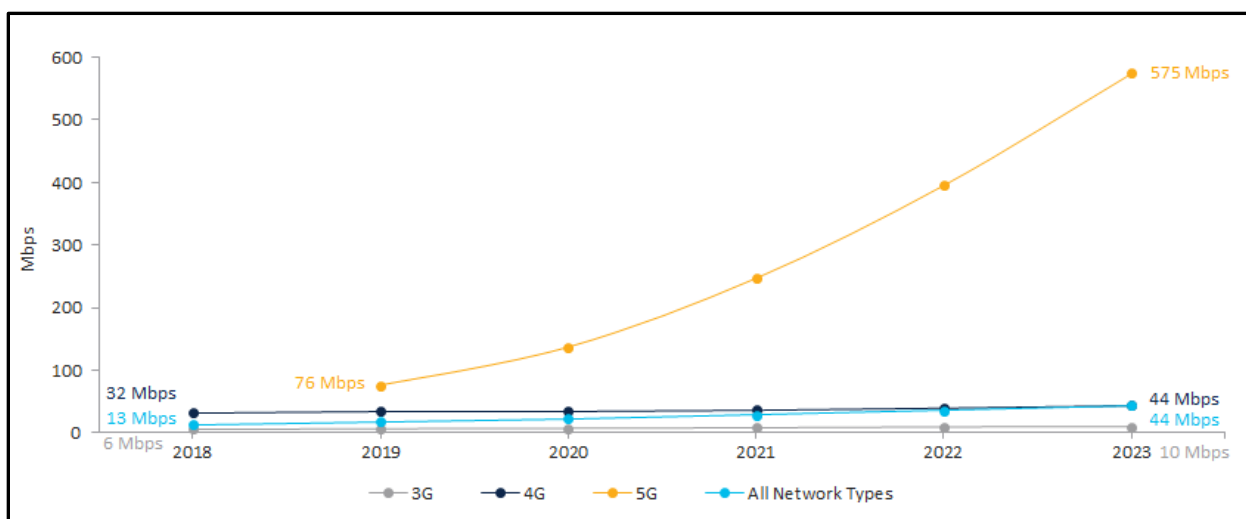

## Dynamic Spectrum Sharing

Traditionally, spectrum has been allocated to various technology generations in a static manner, typically in blocks of 5 MHz or multiples thereof. As new technology generations are introduced, spectrum has been re-farmed block by block to serve the next generation as device mix changes. Manual spectrum re-farming, however, creates an operational burden because it requires careful planning, coordination, and execution to avoid degradation in end-user performance.

DSS technology creates the ability to introduce 5G faster and more efficiently compared to static spectrum re-farming, while also leveraging pooling gains by operating two technologies in the same spectrum band.

Additionally, DSS improves spectrum use by reducing the effect of having a spectrum block tied up to a technology that is lightly loaded. DSS achieves this result by enabling dynamic allocation of radio resources as required by a technology (LTE and 5G). In terms of system performance, DSS does not improve spectral efficiency; rather, it increases spectrum utilization when possible.

Figure 24 illustrates 5G spectrum sharing.

<sup>64</sup> Samsung, "SK Telecom and Samsung Completed 4G-5G Network Dual Connectivity Test Achieving 2.7Gbps," Mar. 13, 2019. <https://news.samsung.com/global/sk-telecom-and-samsung-completed-4g-5g-network-dual-connectivity-test-achieving-2-7gbps>.

<sup>65</sup> Cisco, *Annual Internet Report, Complete Forecast Update, 2018-2023*, Feb. 2020. <https://www.cisco.com/c/en/us/solutions/executive-perspectives/annual-internet-report/index.html>.

**Figure 24: Dynamic Spectrum Sharing<sup>66</sup>**

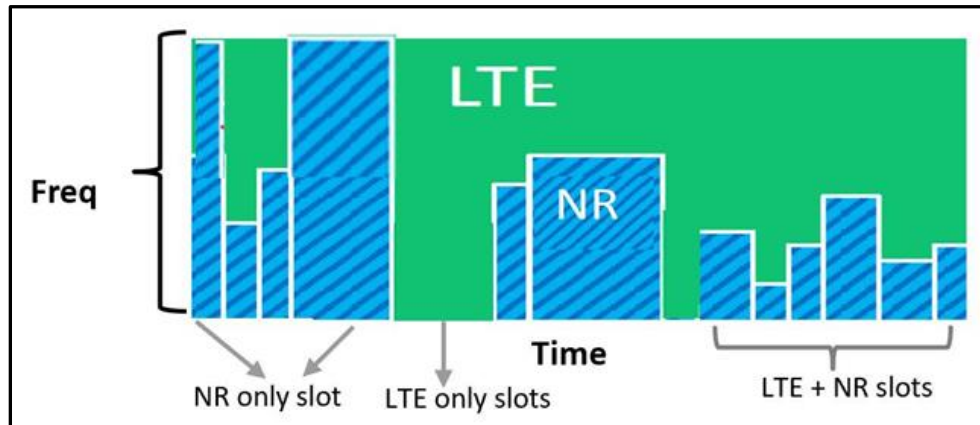

Despite its advantages, DSS does result in some loss of capacity, including voice, due to the additional overhead of having two radio access technologies operating in the same spectrum block. DSS can only be implemented for channel bandwidths of at least 10+10MHz.

In order for resource allocation to be coordinated, DSS requires LTE and NR schedulers to communicate with each other, and so LTE and NR baseband hardware needs to be collocated with low latency. Radio hardware should also support RF sharing between LTE and NR.

For further information, refer to the appendix section, "Dynamic Spectrum Sharing in More Detail."

## **5G Network Slicing**

Not only do 5G networks include a new radio and core, but thanks to virtualization, these networks can present multiple faces for different use cases using an architectural approach called network slicing. Network slicing is defined in the 3GPP Release 15 specifications. Further enhancements to network slicing occur in successive releases. This architecture allows an operator to provide multiple services with different performance characteristics. Each network slice operates as an independent, virtualized version of the network designed to serve a defined business purpose or customer. Thus, each slice consists of all the network resources required to address the specific need. For a given application, the network slice is the only network it sees. The other slices, to which the customer is not subscribed, are invisible and inaccessible. The advantage of this architecture is that the operator can create isolated, fine-tuned slices for specific use cases.

Slicing can accommodate:

- ❑ Requirements on functionality, such as priority, charging, policy control, security, and mobility.
- ❑ Performance, including latency, availability, data rates, and reliability.

---

<sup>66</sup> T-Mobile contribution.

- ❑ Specific users, such as public safety, specific enterprise, roaming, and MVNOs.

GSMA has identified the following industry segments as ones that will benefit from network slicing:<sup>67</sup>

- ❑ Augmented Reality and Virtual Reality
- ❑ Automotive
- ❑ Energy
- ❑ Healthcare
- ❑ Manufacturing
- ❑ Internet of Things
- ❑ Public Safety
- ❑ Smart Cities

Network Slice identification is done via the Single Network Slice Selection Assistance Information (S-NSSAI), which contains the Slice/Service type (SST). The SST refers to the expected Network Slice behavior in terms of features and services. The NSSAI (Network Slice Selection Assistance Information) is a collection of S-NSSAIs.

Currently, 3GPP allows up to eight S-NSSAIs in the NSSAI to be sent in signaling messages between the mobile device and the network. This means a single UE may be served by at most eight network slices at a time.

3GPP has identified four standardized Slice/Service Types (SSTs) shown in Figure 25.

**Figure 25: Standardized Slice/Service Types<sup>68</sup>**

Slice/Service type	SST value	Characteristics
eMBB	1	Slice suitable for the handling of 5G enhanced Mobile Broadband.
URLLC	2	Slice suitable for the handling of ultra- reliable low latency communications.
MIoT	3	Slice suitable for the handling of massive IoT.
V2X	4	Slice suitable for the handling of V2X services.

3GPP also defines Network Slice as a Service (NSaaS). NSaaS can be offered by a Communication Service Provider (CSP) to its Communication Service Customer (CSC) in the form of a communication service. NSaaS also allows the CSC to use and optionally manage the network slice instance. CSC can play the role of CSP and offer its own services (e.g. communication services) on top of the network slice instance.

<sup>67</sup> GSMA, *Network Slicing, Use Case Requirements*, April 2018.  
<https://www.gsma.com/futurenetworks/wp-content/uploads/2018/04/NS-Final.pdf>.

<sup>68</sup> 3GPP, *System architecture for the 5G System*, Table 5.15.2.2-1, 3GPP TS 23.501 V16.4.0 (2020-03).  
<https://portal.3gpp.org/desktopmodules/Specifications/SpecificationDetails.aspx?specificationId=3144>

**Figure 26: Network Slice as a Service**

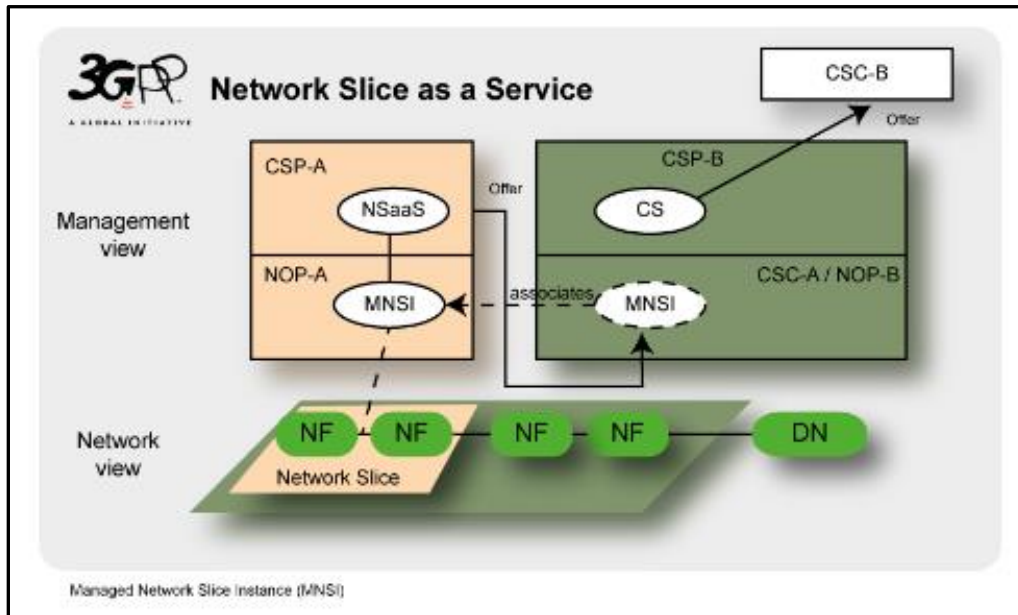
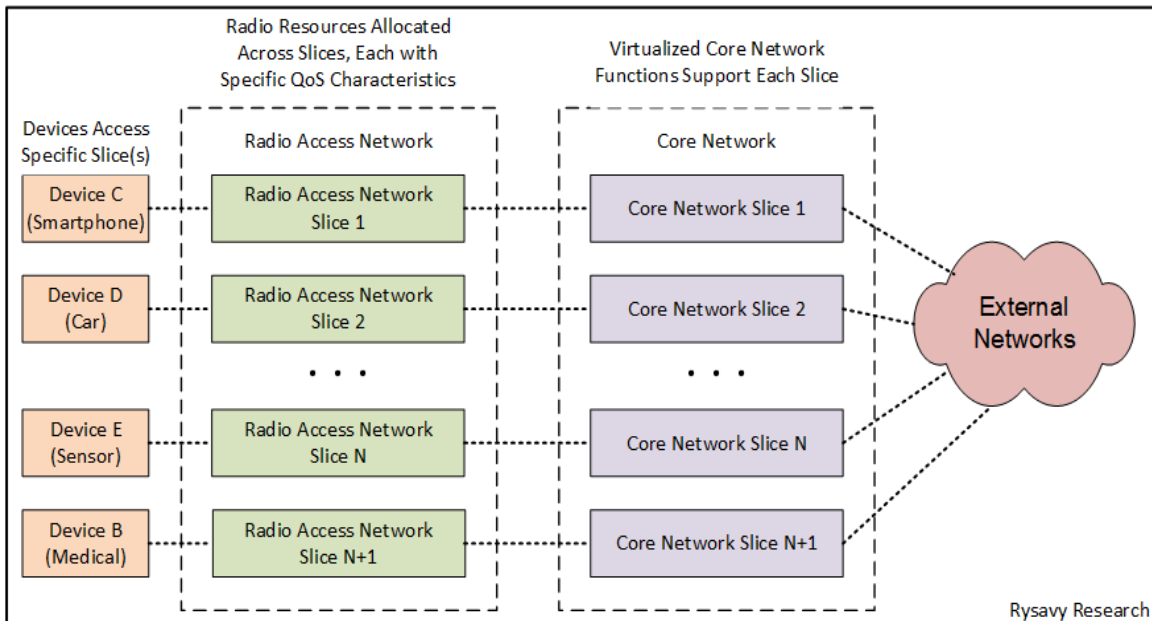

Figure 27 shows the network slicing architecture, with devices having access to only the slice or slices for which they have subscriptions. Each slice has radio resources allocated, with specific QoS characteristics. Within the core network, virtualized core network functions support each slice and provide connections to external networks.

**Figure 27: Network Slicing Architecture**



End-to-end data analytics will facilitate advanced network slicing capabilities in 5G networks. In support of such analytics, 3GPP and other organizations have defined a

number of capabilities, including 3GPP's Management Data Analytics Services (MDAS).<sup>69</sup> Within this architecture, The Network Data Analytics Function (NWDAF), RAN Data Analytics Function (RAN-DAF), and Management Data Analytics Function (MDAF) collect and provide data analytics for use by other functions, including the Policy Control Function for policy decisions and the Network Slice Selection Function (NSSF) for slice management.

Telemetry data analytics-based statistics from NWDAF and RAN-DAF, combined with artificial intelligence and machine learning, will allow operators to dynamically optimize their networks and automate 5G network slicing management. Network slicing will likely progress from a smaller number of manually configured static slices that evolve to larger numbers of slices dynamically configured for shorter periods of time.

5GPPP MoNArch has developed the "5G Mobile Network Architecture"<sup>70</sup> that specifies a detailed management framework for 5G network slicing. Its Integrated Data Analytics Framework employs NWDAF, RAN-DAF, and MDAS.

Figure 28 shows the data analytics framework in 5G-MoNArch, including the interaction between the network layer and orchestration-and-management (O&M) layer for data collection and analytics sharing.

**Figure 28: 5G-MoNArch Data Analytics Framework**

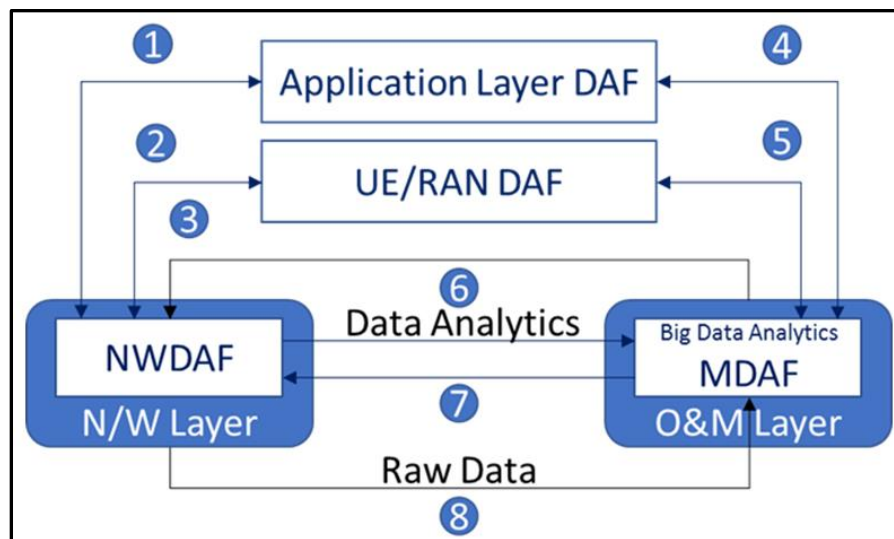

The interfaces in this framework, as explained in the MoNArch architecture document, are as follows:

<sup>69</sup> 3GPP, *Management and orchestration; Architecture framework*, 3GPP TS 28.533. <https://portal.3gpp.org/desktopmodules/Specifications/SpecificationDetails.aspx?specificationId=3416>

IEEE, "End-to-End Data Analytics Framework for 5G Architecture," Mar. 5, 2019. <https://ieeexplore.ieee.org/stamp/stamp.jsp?arnumber=8660442>.

<sup>70</sup> 5GPPP MoNArch, *5G Mobile Network Architecture*, Deliverable D2.3, Apr. 30, 2019. [https://5g-monarch.eu/wp-content/uploads/2019/05/5G-MoNArch\\_761445\\_D2.3\\_Final\\_overall\\_architecture\\_v1.0.pdf](https://5g-monarch.eu/wp-content/uploads/2019/05/5G-MoNArch_761445_D2.3_Final_overall_architecture_v1.0.pdf).

- ❑ Interface 1: NWDAF interacts with the Analytics Function (AF) via the Network Exposure Function (NEF) using the network (NW) layer Service Based Interface (SBI).
- ❑ Interface 2: N1/N2 interface.
- ❑ Interface 3: The O&M layer configures the Network Function (NF) Profile in the Network Repository Function (NRF), and NWDAF collects the NF capacity information from the NRF.
- ❑ Interface 4: MDAF interacts with application/tenant using the Northbound Interface (NBI).
- ❑ Interface 5: MDAF interacts with the RAN DAF using O&M layer SBI.
- ❑ Interface 6: NWDAF consumes the services provided by MDAF using the cross-layer SBI.
- ❑ Interface 7: MDAF consumes the services provided by MDAF using the cross-layer SBI.
- ❑ Interface 8: MDAF collects data from NW layer via trace file/monitoring services.

Although managing QoS across multiple slices is complex, a number of factors drive such capability:

- ❑ New use cases enabled by 5G, representing significant new business opportunities, will depend on network management and traffic prioritization.
- ❑ The virtualization of 5G networks augmented by eventual AI-capabilities will facilitate the necessary network management.
- ❑ Small or smaller cells with a smaller number of devices in the coverage area along with greater capacity will simplify RAN QoS management.

## ***5G NR Cellular Positioning***

Cellular Positioning Technologies make use of signal measurements from cellular base stations and devices, and therefore, typically rely on existing cellular infrastructure.

Historically, the main driver for cellular-based location services were requirements from regulatory authorities. However, multiple applications and use cases can benefit from commercial location-based services, which often require higher location accuracy and lower latency. The use cases for such cellular-based or cellular-aided location accuracy are broad and include augmented reality, wearables, industry, automotive, traffic management, hospitals (for example, person and medical equipment location), bikes, and aerial vehicles (drones).

5G nR Release 16 Positioning is designed to offer a variety of positioning technologies delivering UE position information depending on the needs of specific use cases. To address the diverse location requirements resulting from new applications and industry verticals, NR Release 16 cellular positioning supports multiple positioning technologies enabled by the following key features:

Key physical-layer technologies:

- ❑ New NR positioning reference signals (PRS) for DL & UL

- ❑ Round-trip time (RTT) measurements with multiple base stations (Multi-RTT)
- ❑ DL & UL time difference of arrival (TDOA) measurements
- ❑ gNB Angle of Arrival (AoA) or Angle of Departure (AoD) measurements

Key upper-layer technologies:

- ❑ LTE Positioning Protocol (LPP) for NR Positioning
- ❑ Support for UE-based NR Downlink-only positioning methods
- ❑ Support for broadcast of location assistance data

Refer to the appendix section “5G NR Cellular Positioning in Detail” for additional information.

## **5G Network Types and Operator Strategies**

Because the scalability and flexibility of 5G allows operators to leverage their specific spectrum and fiber assets, and because 5G supports many use cases, operators can pursue a variety of business models.

On a global basis, some countries are licensing mmWave spectrum (see the section “5G mmWave Bands”), but most are emphasizing mid-band deployments in the 3 GHz to 5 GHz range. Mid-band, assuming 100 MHz licensed to each operator, provides a good capacity and performance boost compared to lower bands, but does not require the dense small-cell deployment needed for mmWave. Specifically, mid-band 5G can be deployed in cells with 500-meter or even 1000-meter inter-site distance (ISDs), whereas mmWave typically will employ ISDs of 250 meters.<sup>71</sup> The denser mmWave network, however, will offer significantly greater capacity and performance. Consequently, mid-band could be used as a wireline replacement in rural areas, but such capability will mandate mmWave in urban areas.

For mid-band and low-band deployments, 5G signals from outdoor cell sites will have reasonable indoor penetration. Figure 29 shows significant indoor coverage when co-siting NR with existing outdoor LTE cell sites.

---

<sup>71</sup> Rysavy Research, *5G Network Planning—Capacity, Performance, Wireline Competitiveness*, 2019. <https://rysavy.com/broadband-reports/>.

**Figure 29: Indoor 5G NR Coverage Co-Siting with Existing Outdoor LTE Sites<sup>72</sup>**

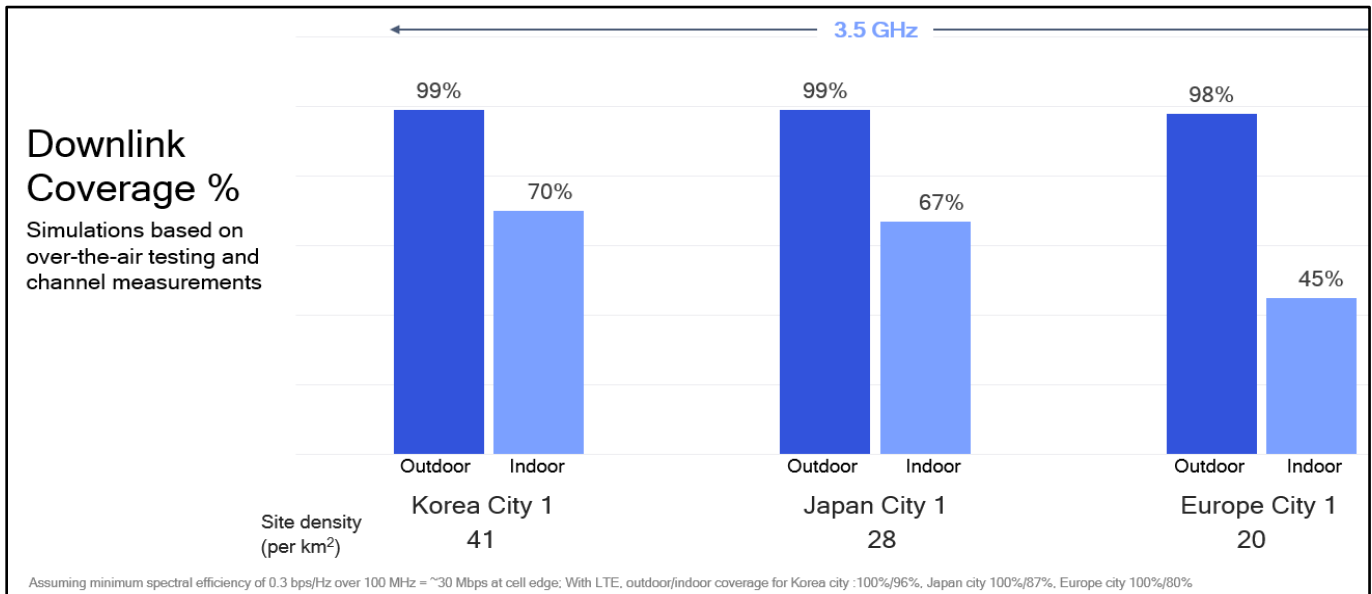
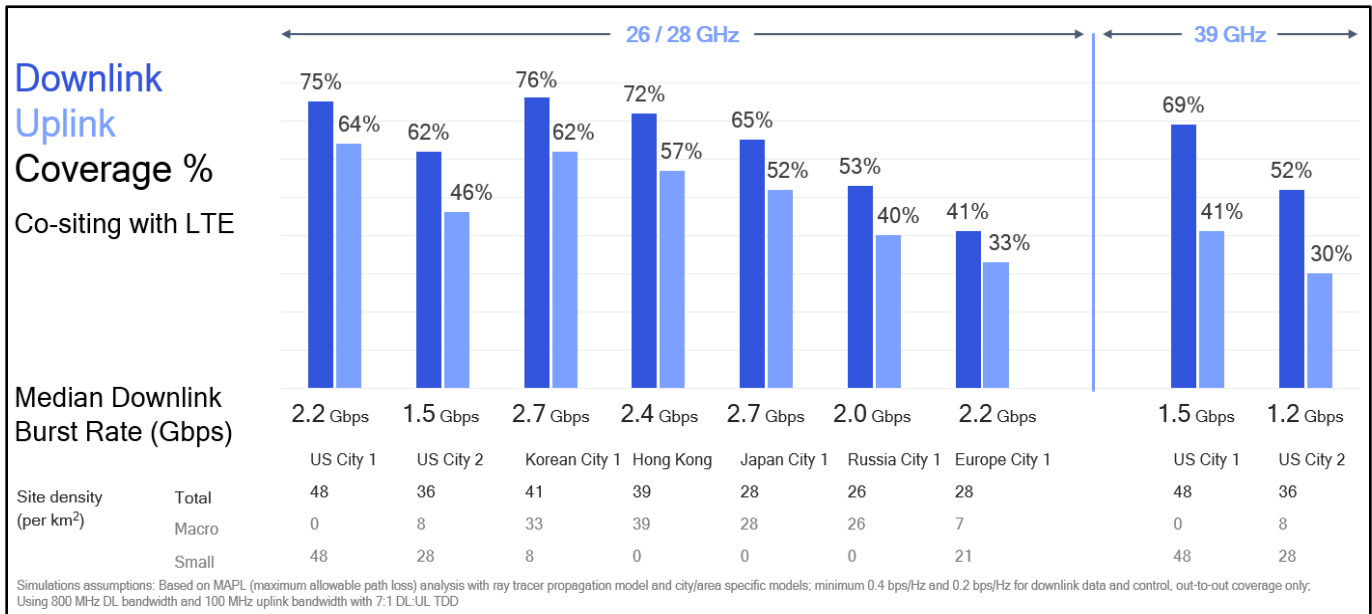

Figure 30 shows effective outdoor coverage at mmWave frequencies by co-siting at LTE cell sites, meaning that in urban areas with already dense LTE coverage, fewer 5G cells will be needed to provide effective outdoor coverage.

**Figure 30: mmWave Coverage Achieved by Co-Siting with LTE<sup>73</sup>**



<sup>72</sup> Qualcomm contribution. Qualcomm webinar, "How do we plan for 5G NR network deployments coming in 2019?" Nov. 2018.

<sup>73</sup> Qualcomm contribution. Qualcomm webinar, *What new indoor opportunity will 5G NR mmWave bring?* Feb. 2019.



However, mmWave signals are easily blocked by walls, requiring the following approaches to provide effective indoor coverage:

- ❑ Repeaters that forward the 5G NR signal indoors
- ❑ Routers that receive the 5G signal outside, then provide a Wi-Fi signal indoors (the approach used for fixed wireless access)
- ❑ Indoor access points

Although mmWave operates at higher frequencies than Wi-Fi, co-siting with Wi-Fi can provide effective coverage because the signal reflects off indoor surfaces, as shown in Figure 31.

**Figure 31: Co-Siting mmWave 5G NR with Wi-Fi Indoors for Effective Coverage<sup>74</sup>**

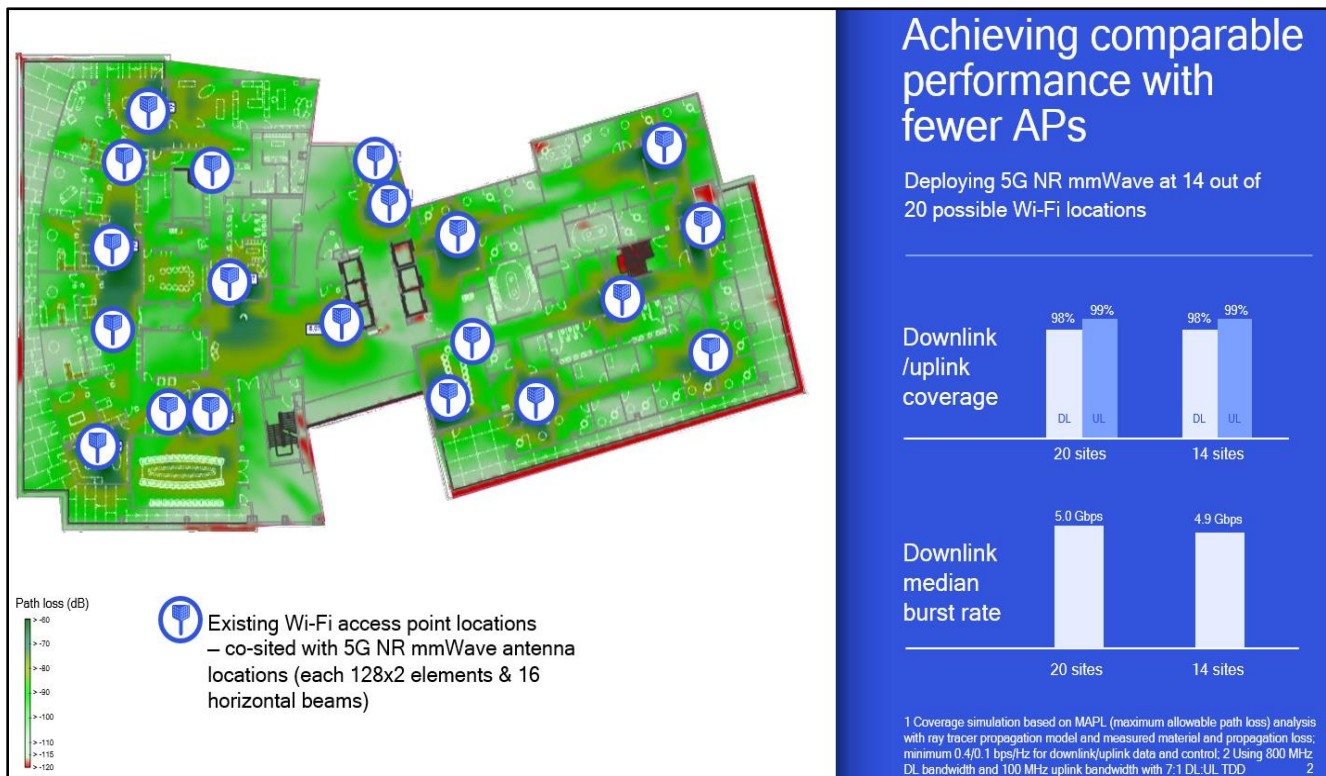

Engineers generally expect that with mmWave, indoor access points will supply indoor coverage and outdoor cell sites will provide outdoor coverage. This approach, although requiring more infrastructure, allows effective frequency re-use and will ultimately create networks with extraordinary capacity and performance.

### ***Integrated Access and Backhaul***

With increasing network densification, providing traditional fiber backhaul access to every cell site has become extremely difficult; this is especially true for small cell base stations. One of the technologies specified in Release 16 is wireless self-backhaul, called integrated

<sup>74</sup> Ibid.

access and backhaul, which can enable flexible and very dense network deployment without the need for densifying the transport network accordingly, especially when using mmWave bands. Compared with LTE, 5G NR can achieve much wider bandwidth and offer much higher throughput and network capacity through massive MIMO and multi-beam systems deployment. IAB links in 5G will be able to share the same radio resources with the macro donor access links to provide backhaul for other IAB nodes, as shown in Figure 32.

**Figure 32: 5G Integrated Access and Backhaul**

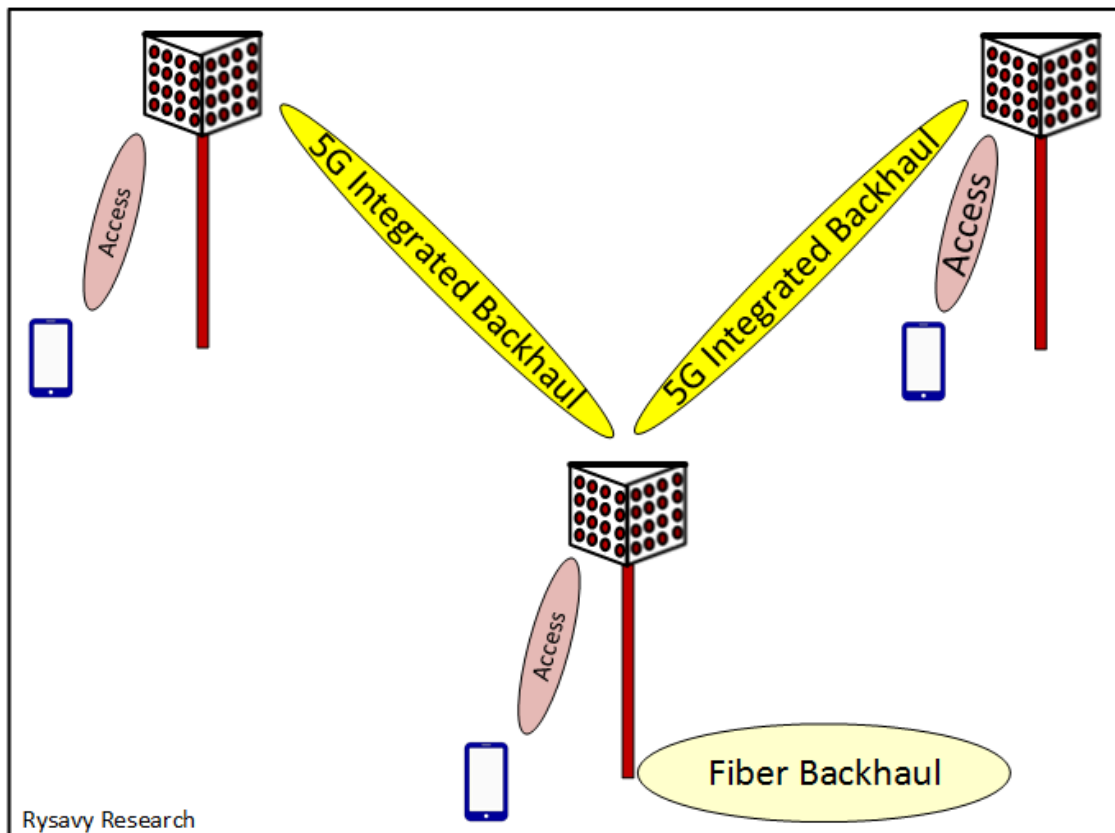

IAB will provide multiple benefits, including reducing the need for fiber to each cell site, remediating isolated coverage gaps, enhancing capacity, and bridging from outdoor to indoor.

Specific capabilities include:

- ❑ Support for legacy terminals, requiring no specific UE features.
- ❑ Spectrum allocation between access and backhaul for efficient spectrum usage.
- ❑ In-band (same band for both access and backhaul) and out-of-band (separate bands for access and backhaul) capability for maximum spectrum flexibility.
- ❑ Support for both standalone and non-standalone 5G architectures.
- ❑ Multi-hop capability for extended range or to support complex topologies such as convoluted urban canyons.

- ❑ Flexible QoS support including end-to-end QoS and individual traffic flows across both access and backhaul links.
- ❑ Robustness with path redundancy in the wireless backhaul topology.
- ❑ Dynamic load balancing across backhaul links to optimize backhaul capacity for time-dependent traffic loads.
- ❑ Centrally controlled management functions with local decision-making processes for flexible and fast response to dynamic resource demand.

IAB use cases include cell densification, filling coverage holes, extending coverage along streets or highways, and providing infrastructure on demand, such as at a stadium or hazard zone.

See the 5G appendix sections “Architecture in More Detail” and “Integrated Access and Backhaul in More Detail” for additional information. See also the 5G Americas white paper, *Innovations in 5G Backhaul Technologies*.<sup>75</sup>

## 2020-2030 Technology Evolution

To appreciate wireless technology in the broader, evolving technology landscape, this new section presents a speculative ten-year view of technology evolution in the 2020-2030 period. Development of current standards through 3GPP Release 17 provides a detailed view of network capability only about four years into the future. Seeing what comes beyond then requires forward thinking and examination of the technology currently being researched.<sup>76</sup>

---

<sup>75</sup> 5G Americas, *Innovations in 5G Backhaul Technologies*, Jun. 2020.  
<https://www.5gamericas.org/innovations-in-5g-backhaul-technologies/>.

<sup>76</sup> Material for this section contributed by Cisco and T-Mobile and inspired by the following:

Dean Buble, “Predictions for the next decade: looking out to 2030 for telecoms, wireless & adjacent technologies,” Jan 3, 2020.

IEEE Communications, “Towards 6G Networks: Use Cases and Technologies,” Mar. 2020.

IEEE, *6G: The Next Frontier*, May 2019.

IEEE, *What Will 6G Be?* May 2019.

IEEE Spectrum, *It’s Never Too Early to Think About 6G*, May 2018.

Institute for Communications and Navigation, German Aerospace Center, DLR, Department of Electronic Systems, Aalborg University, *From 5G to 6G: Has the Time for Modern Random Access Come?* Mar. 2019.

ITU, *Network 2030, A Blueprint of Technology, Applications and Market Drivers Towards the Year 2030 and Beyond*, 2019.

NTT DOCOMO, *5G Evolution and 6G*, Jan. 2020.

Samung, *6G – The Next Hyper-Connected Experiences for All*, Jul. 2020.  
<https://cdn.codeground.org/nsr/downloads/researchareas/6G%20Vision.pdf>.

Organizations are already examining the future. For instance, Alliance for Telecommunications Industry Solutions (ATIS) launched the “3GPP Release 17 & Beyond” initiative in January 2019<sup>77</sup> to develop ATIS’s vision of standards roadmap for 3GPP post-Release 16. ATIS’s initiative identified key technologies and considered how the transformational societal/business impacts of these technologies will drive requirements. 5G innovation and other trends are emerging with a surprising number of futuristic technologies on the horizon over the next decade, the estimated date for widespread 5G deployment.

In addition, the ITU Focus Group on Technologies for Network 2030 states that it, “intends to study the capabilities of networks for the year 2030 and beyond, when it is expected to support novel forward-looking scenarios, such as holographic type communications, extremely fast response in critical situations and high-precision communication demands of emerging market verticals.”<sup>78</sup>



## ***Application Evolution***

Improving wireless capability will bring new use cases and applications. 4G enabled applications such as video streaming, but these had restrictions, such as resolution and hours viewed per day. 5G, especially if deployed at the wide bandwidths enabled by 5G, will have far greater capacity and can function as an effective wireline broadband replacement. It will also enable high-bandwidth applications such as AR and VR. But even greater-bandwidth applications that will demand even more from the network, such as 3D holographic communication and digital replication of the physical world, are on the way.

Table 5 summarizes what is possible today with 4G, what 5G brings, and what may be possible in future (beyond 5G) networks.

---

University of Bologna, Marco Chiani, Enrico Paolini, Franco Callegati, *Open issues and beyond 5G*.

Walid Saad, Mehdi Bennis, Mingzhe Chen, Virginia Tech, *A Vision of 6G Wireless Systems: Applications, Trends, Technologies, and Open Research Problems*, Feb. 2019.

<sup>77</sup> ATIS, “3GPP Release 17 & Beyond.” [https://www.atis.org/01\\_topsc/r17b/](https://www.atis.org/01_topsc/r17b/)

<sup>78</sup> ITU, “Focus Group on Technologies for Network 2030,” <https://www.itu.int/en/ITU-T/focusgroups/net2030/Pages/default.aspx>, last viewed Apr. 13, 2020. See also IEEE Future Networks, <https://futurenetworks.ieee.org/>; 6G Flagship, <https://www.oulu.fi/6gflagship/>.

**Table 5: Evolution from 4G to Beyond 5G**

	4G	5G	Future Technology Beyond 5G (Speculative)
<b>Peak Theoretical Throughput</b>	1 Gbps	20 Gbps	1 Tbps (1000 Gbps)
<b>Typical Throughputs</b>	10s of megabits per second (Mbps)	100s of Mbps to more than 1 Gbps	10s or 100s of Gbps
<b>Wireline Broadband Replacement</b>	Only viable for small percentage of users	Viable for many users	Viable for nearly all users
<b>Video</b>	Streaming video but with restrictions, HD possible	Fewer restrictions, UHD possible	Super-high resolution
<b>Types of Communications</b>	Voice, interactive video	HD interactive, VR	Immersive telepresence and 3D holographic
<b>Reliability</b>	Networks mostly operates on best-effort basis	Designed for mission-critical applications (capable of six nines of reliability 99.9999%)	Nine nines of reliability
<b>Latency (radio network delay)</b>	As low as 10 msec	As low as 1 msec	Even greater timing precision, for example, 100 microseconds
<b>Device Density</b>	100 thousand devices/sq. km	1 million devices/sq. km	10 million devices/sq. km
<b>Spectral Efficiency</b>	High	Three times higher than 4G	Two times higher than 5G

The evolved-5G capabilities expected during the 2020s, combined with developments in computer miniaturization and artificial intelligence, will create an augmented-reality overlay on human experience.

Research underway could make device interaction touchless, based only on natural human voice communication or gestures. Wearable devices will become ubiquitous, for example in watches, and others speculate devices that can be implanted in our bodies, on contact lenses, via direct-brain interfaces, or in our ears. An in-ear device, for example, could measure brain electrical activity, temperature, skin resistance, stress hormone levels, blood oxygen, vagus nerve stimulation, eye movements, movement, and heart rate. With this data, a health application could detect mental effort, stress, engagement, excitement, physical health, what is calming, what a person is paying attention to, and where their eyes are directed.<sup>79</sup> These devices must account for privacy and security issues.

---

<sup>79</sup> For further details, refer to IEEE Spectrum, "Here Come the Hearables," May 2019.

## **Radio Evolution**

Radio technology continues to increase in sophistication. 5G represents today's state of the art for what can be practically deployed, but researchers are already studying what comes next by examining dimensions such as:

- ❑ Expansion from the approximate 100 GHz limit of 5G to 400-700 GHz,<sup>80</sup> the upper limits for wireless communications and referred to as terahertz frequencies.<sup>81</sup>
- ❑ Going beyond radio and harnessing free-space optical communications (now only used in limited ways).
- ❑ Evolving antenna technology, both at sub-6 GHz and mmWave/THz, including using new materials to create even higher-order MIMO and a greater number of elements for narrower radio beams. Researchers anticipate 1000 simultaneous beams that reach 10 Tbps of aggregate throughput. Virtual massive MIMO approaches have also been proposed, by which a single antenna simulates multiple antennas through oversampling and variation of antenna characteristics.
- ❑ Advanced repeaters and multi-hop relays that help propagate mmWave signals.
- ❑ Transmission and reception of radio signals by large, intelligent surfaces based on electromagnetically active surfaces (e.g., using metamaterials).
- ❑ AI-based spectrum sharing approaches with which multiple entities can efficiently share the same spectrum.
- ❑ Wireless energy transfer enabling extended or infinite battery life for mobile devices.
- ❑ Full-duplex communications for simultaneous transmission and reception on the same radio channel.
- ❑ Cell-less architecture by which user equipment connects to the radio access network and not a specific cell.
- ❑ Higher consideration for lower energy use than in 5G.
- ❑ Modern random-access methods, including advanced receivers and non-orthogonal multiple access, that could be more efficient for IoT communications.

## **Network Evolution**

Beyond radio advances, networks themselves will continue to evolve during the 2020s with innovations such as:

- ❑ Application of intelligence and machine learning in every aspect of the network to increase efficiency, security, and reliability.

---

<sup>80</sup> 5G Americas member analysis.

<sup>81</sup> One terahertz is 1,000 GHz; however, the terahertz frequency range can denote 100 GHz (0.1 THz) to 10 Hz. For example, see ITU, *Technology trends of active services in the frequency range 275-3000 GHz*, Report ITU-R SM.2352-0, Jun. 2015. [https://www.itu.int/dms\\_pub/itu-r/opb/rep/R-REP-SM.2352-2015-PDF-E.pdf](https://www.itu.int/dms_pub/itu-r/opb/rep/R-REP-SM.2352-2015-PDF-E.pdf).

- ❑ Ultra-densification with access points at every street corner and mmWave distributed throughout indoor environments, making extensive use of wireless self-backhaul.
- ❑ Terrestrial networks augmented with non-terrestrial networks, including UAVs, high altitude platform stations (e.g., 20 km altitude), and low-earth orbiting (LEO) satellites.
- ❑ Virtualization of every aspect of the network, except the radio head, using open interfaces. (Building on work in 4G and 5G, including efforts such as Open Radio Access Network [O-RAN].)
- ❑ High resilience against attacks and disasters, especially as these networks become critical infrastructure.
- ❑ Elasticity for on-demand service configurations to address specific use cases supported by dynamic radio and computing resources.
- ❑ Intent-based network management by which the network translates business policies into network planning and device configuration.
- ❑ Greater adoption by enterprises of private cellular-technology networks, many integrated with public networks. These will be standalone or operated in partnerships with cellular operators.
- ❑ New business models, such as “spectrum-as-a-service” with flexible resale and temporary usage permissions, new forms of network aggregators, and new types of virtual operators.

With these new networks, spectral-efficiency design considerations will move from efficiency over area to efficiency over volume.

Figure 33 shows the transformation of networks, moving from 4G to beyond 5G.

**Figure 33: Network Transformation**

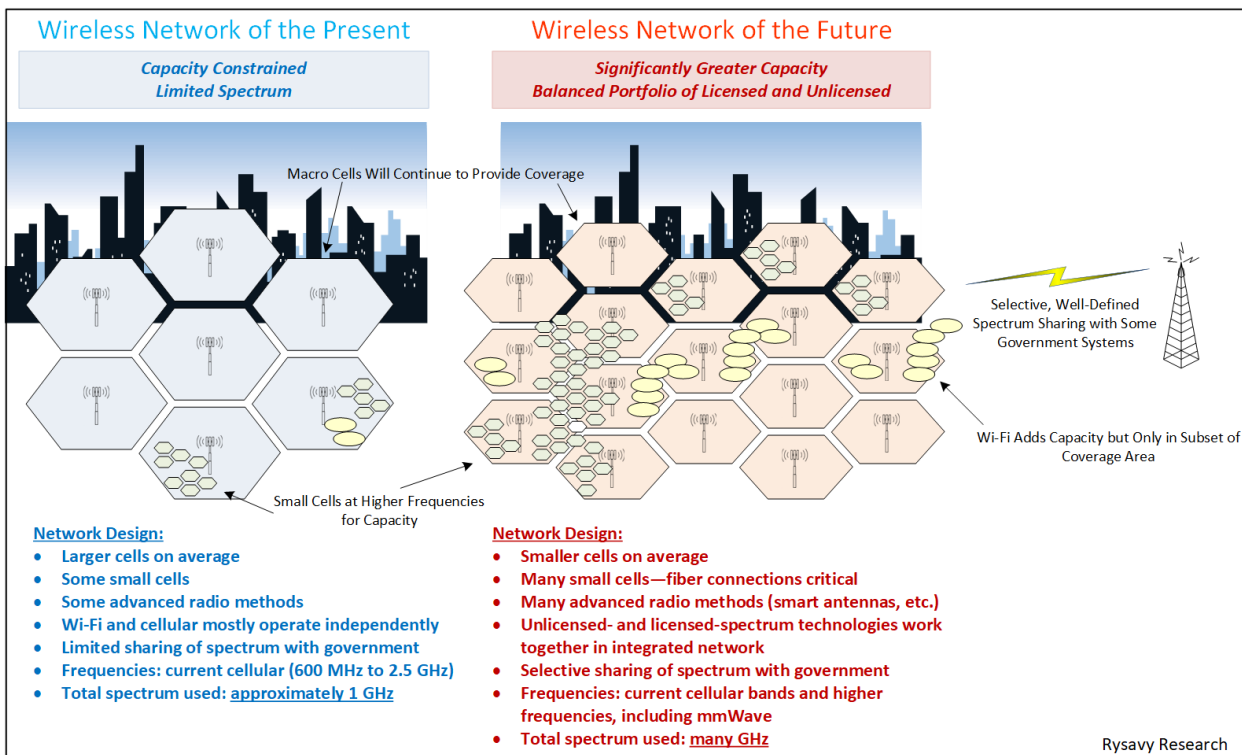

## ***Distributed Computer Intelligence***

The power of the advancing capability of networks in the 2020s will be augmented in computer innovations, including:

- ❑ Widespread adoption of edge computing.
- ❑ Artificial intelligence distributed from cloud to edge to device with deep-learning capabilities.
- ❑ Quantum computing for cryptographic and other as-of-yet unimagined applications.

## ***Standards Evolution***

Wireless networking standards will need to evolve to keep pace with advancing technology. Figure 34 presents the timeline of technology generations, including past and future, showing initial deployment, the year of the peak number of subscribers, and decline. Each cellular generation spans multiple decades, with peak adoption occurring some twenty years after initial deployment. An ITU IMT-2030, or “6G” standards development in the 2030 timeframe, though highly speculative, is consistent with previous generations. Acceleration in technology development, combined with virtualization, software-defined networks, and open source, could tighten the development timeframe.

Within any decade-long generational development cycle, researching technologies that might be feasible for the next generation occupies about the first one-third of time. Envisioning the future system and developing the associated requirements occupies about



the second third of time, and developing specifications for the new generation occupies about the final third of time.

**Figure 34: Timeline of Cellular Generations**

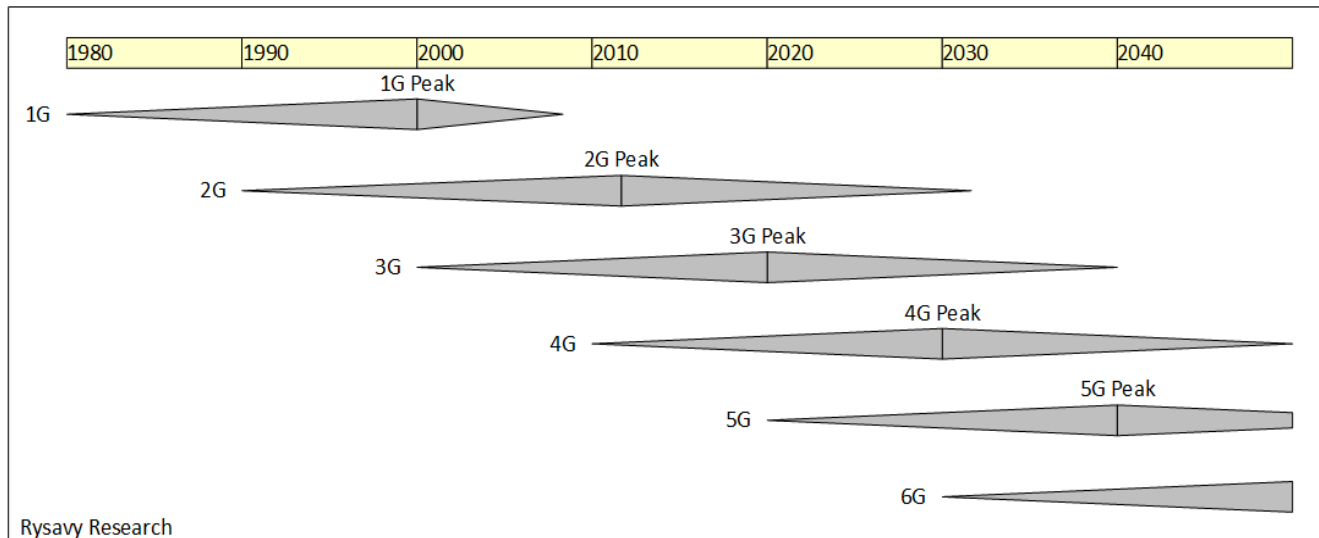

## ***Challenges toward this Future***

The future of wireless technology is promising, with significant progress occurring over the next decade, but challenges will be multifold, including the following:

- ❑ Edge computing shows great promise, but it could be fragmented by different operator architectures, different types of entities (existing cloud vendors, operators, enterprises, new entrants), and a multitude of software development environments. Edge computing will also have to integrate with existing cloud services.
- ❑ Higher-frequency components will require greater real-time processing.
- ❑ Terahertz signals will be even more difficult to propagate than mmWave signals.
- ❑ Close component spacing and increased processing will generate heat, limiting how compact devices can be.
- ❑ Communities may resist or reject the placement of millions of access devices needed for super-dense networks.
- ❑ QoS capabilities, essential for architectures such as network slicing, are still in early stages of adoption on a widespread basis. Much remains to be learned about dynamically managing the varying needs of thousands of different types of applications, as well as maintaining QoS across different types of network connections.
- ❑ Security concerns will increase as more devices are placed on the network, with specific vertical applications requiring high levels of security.
- ❑ Privacy concerns may also slow down the installation of massive numbers of sensors and devices capable of surveillance.

- ❑ Regulatory frameworks, especially contentious ones such as network neutrality and siting regulations, may not be able to keep up with technology, inhibiting wide-scale adoption. Countries that adapt the fastest with effective policy will achieve a strategic advantage.
- ❑ Federal efforts to ease the way for ultra-dense deployments are already facing legal challenges from local municipalities, which want to retain control over deployments and maximize local revenue opportunities from siting licenses.
- ❑ Global technology fragmentation could occur as a result of tensions, such as the current conflict between the United States and China.

## Internet of Things and Industrial IoT

Current M2M and Internet of Things applications include vehicle infotainment, connected healthcare, transportation and logistics, connected cars, home security and automation, manufacturing, construction and heavy equipment, energy management, video surveillance, environmental monitoring, smart buildings, wearable computing, object tracking, and digital signage. Municipalities, evaluating the concept of “smart cities,” are exploring how to optimize pedestrian and vehicular traffic, connect utility meters, and deploy trash containers that can report when they need emptying.

Although promising, the IoT market is also challenging, with varying communications requirements, long installation lifetimes, power demands that challenge current battery technology, cost sensitivity, security and data privacy concerns, and unsuitability of conventional networking protocols for some applications. Consequently, the IoT opportunity is not uniform; it will eventually comprise thousands of markets. Success will occur one sector at a time, with advances in one area providing building blocks for the next.

To address the IoT opportunity, 3GPP is defining progressive LTE and 5G refinements that will occur over multiple 3GPP releases. These refinements include low-cost modules that approach 2G module pricing and enable multi-year battery life. 5G augments IoT capabilities by enabling higher device densities, longer battery life, lower latency, and ultra-reliable connections.

The lowest-cost cellular devices enabling IoT communications today are GPRS modems, which risk becoming obsolete as operators sunset their GSM systems. HSPA is also used for M2M communications, as is LTE, which has been optimized to efficiently communicate small bursts of information, making it particularly well suited for M2M.

Low-cost GSM (through Enhanced Coverage GSM IoT [EC-GSM-IoT]) and LTE modem options in 3GPP Releases 10 through 13 reduce cost, improve communications range, and extend battery life. See the appendix section “Internet of Things and Machine to Machine” for details.

In Release 14, 3GPP specified how LTE technologies can operate for vehicle communications, including vehicle-to-vehicle and vehicle-to-infrastructure, leveraging device-to-device communications capabilities already specified for LTE in Releases 12 and 13.<sup>82</sup>

---

<sup>82</sup> 3GPP, 3GPP TR 36.885, Technical Specification Group Radio Access Network; *Study on LTE-based V2X Services*; (Release 14).

Release 15 includes further IoT enhancements in LTE, such as TDD support, higher spectral efficiency, and wake-up radio.<sup>83</sup>

Release 16 adds industrial IoT capabilities to 5G NR, vastly expanding the use cases for 5G to include items such as motion control, drone control, industrial sensors, process automation monitoring, and asset tracking. Specific capabilities include:<sup>84</sup>

- ❑ **Ultra-reliable, low latency communications (URLLC).** Latency is as low as 0.5 msec in the downlink and 0.5 msec in the uplink. Packet reliability can be as high as 99.9999% for a 32-byte packet with a user plane latency of 1.0 msec.
- ❑ **Time sensitive networking, including wireless transport of Ethernet.** Uses accurate reference timing, support for deterministic and/or isochronous communication with high reliability and availability, and Ethernet header compression. The base station can signal time reference information to the UE using unicast or broadcast signaling with a granularity of ten nanoseconds.
- ❑ **Indoor positioning.** Provides positioning accuracy within three meters.
- ❑ **Non-public networks.** Enterprises can operate their own networks, either standalone or integrated with public networks. Spectrum can be CBRS, unlicensed 5 GHz or 6 GHz, or licensed if coordinated with an operator.

Release 17 further reinforces IoT capabilities with slicing enhancements, industrial IoT (including URLLC) enhancements, improved positioning, and NR-Light for wider use cases.

NR-Light in Release 17 will address use cases with throughputs higher than those provided by LTE NB-IoT and LTE-M but lower than standard NR while providing lower cost and better battery life than standard NR devices.

Figure 35 shows the timeline of IoT capability in Releases 16 and 17.

---

<sup>83</sup> Qualcomm webinar, "What is the role of LTE Advanced Pro as 5G rolls out in 2019?" Apr. 26, 2018.

<sup>84</sup> For further details, see Amitava Ghosh, Rapeepat Ratasuk and Anil M. Rao, Nokia Bell Labs, "Industrial IoT Networks Powered by 5G New Radio," Dec. 12, 2019. <https://www.microwavejournal.com/articles/33240-industrial-iot-networks-powered-by-5g-new-radio?v=preview>.

**Figure 35: 5G Releases and Industrial IoT Support<sup>85</sup>**

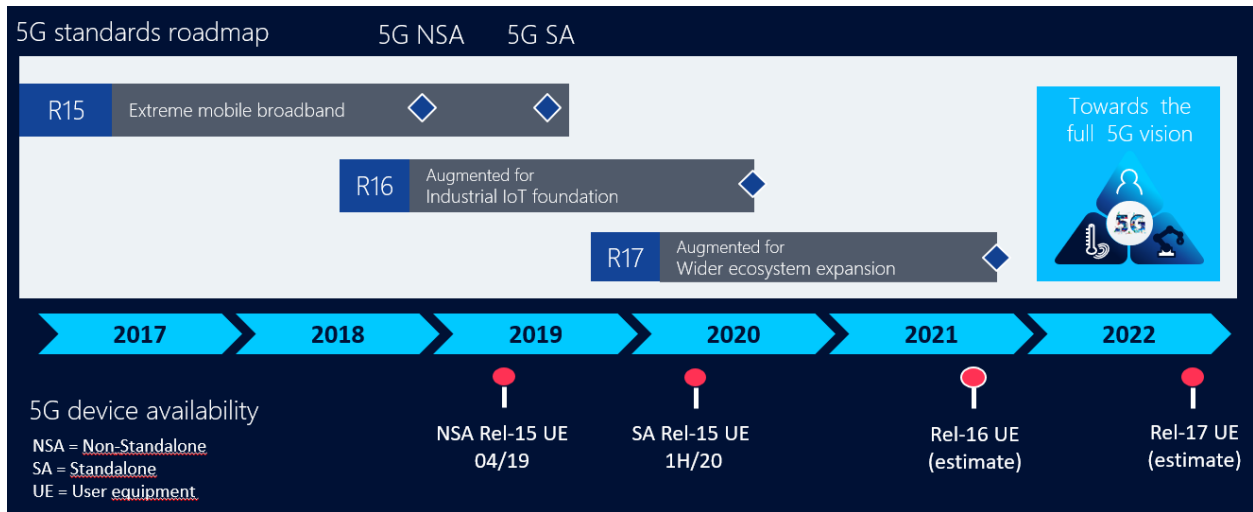

Table 6 lists global deployments of LTE IoT technologies.

<sup>85</sup> Nokia contribution.

**Table 6: Global NB-IoT and LTE-M Deployments<sup>86</sup>**

REGION	COUNTRY	OPERATOR	NB-IoT	LTE-M
Africa			1	0
	South Africa	Vodacom	1	
Asia & Pacific			20	10
	Australia	Telstra	1	1
	Australia	Vodafone Australia	1	
	China	China Telecom	1	
	China	China Unicom	1	
	China	China Mobile	1	
	Hong Kong	China Mobile (HK)	1	
	India	Reliance Jio Infocomm	1	
	Indonesia	Telkomsel	1	
	Indonesia	XL Axiata	1	
	Japan	KDDI (au)		1
	Japan	DOCOMO		1
	Malaysia	Maxis	1	
	New Zealand	Spark		1
	New Zealand	Vodafone New Zealand	1	1
	Pakistan	Telenor Pakistan	1	
	Singapore	M1	1	
	Singapore	Singtel	1	1
	South Korea	KT Corp	1	1
	South Korea	LG Plus	1	
South Korea	SK Telecom		1	
Sri Lanka	Dialog Axiata	1	1	
Taiwan	Asia Pacific Telecom (APT)	1	1	
Taiwan	Far EasTone	1		
Vietnam	Viettel	1		
Eastern Europe			18	0
	Croatia	A1 Croatia	1	
	Croatia	Hrvatski Telecom	1	
	Czech Republic	Vodafone Czech Republic	1	
	Estonia	Elisa	1	
	Estonia	Telia Estonia	1	
	Hungary	Magyar Telekom	1	
	Kazakhstan	KaR-Tel (Beeline)	1	
	Lithuania	Telia Lithuania	1	
	Poland	Polkomtel	1	
	Poland	T-Mobile Poland	1	
	Russia	Beeline (Russia)	1	
	Russia	MegaFon	1	
	Russia	Mobile TeleSystems (MTS)	1	
	Russia	Tele2Russia	1	
	Slovakia	Slovak Telecom	1	
	Slovenia	A1 Slovenia	1	
	Ukraine	Lifecell	1	
	Ukraine	Vodafone Ukraine	1	

REGION	COUNTRY	OPERATOR	NB-IoT	LTE-M
Latin America & Caribbean			2	3
	Argentina	Movistar (Argentina)	1	1
	Brazil	Vivo	1	1
	Mexico	AT&T Mexico		1
Middle East			5	1
	Qatar	Vodafone Qatar	1	
	United Arab Emirates	Du	1	
	United Arab Emirates	Etisalat	1	1
	Turkey	Turkcell	1	
	Turkey	Vodafone Turkey	1	
U.S. & Canada			3	5
	Canada	Bell Canada		1
	Canada	Telus		1
	United States	AT&T	1	1
	United States	T-Mobile US	1	
	United States	US Cellular		1
	United States	Verizon	1	1
Western Europe			17	7
	Austria	T-Mobile	1	
	Belgium	Orange	1	1
	Belgium	Proximus	1	
	Belgium	Telenet	1	
	Denmark	TDC	1	
	Finland	DNA		1
	France	SFR (Altice)	1	
	France	Orange France		1
	Germany	Telekom Deutschland	1	
	Germany	T-Mobile	1	
	Greece	Cosmote	1	
	Ireland	Vodafone Ireland	1	
	Italy	Telecom Italia (TIM)	1	
	Italy	Vodafone Italy		
	Netherlands	KPN		1
	Netherlands	T-Mobile	1	
Netherlands	Vodafone/Ziggo	1		
Norway	Telenor Norway		1	
Norway	Telia Norge	1		
Spain	Orange Espana		1	
Spain	Vodafone Spain	1		
Sweden	Telia Sweden	1		
United Kingdom	O2		1	
Totals			66	26
Global Totals			80	

<sup>86</sup> 5G Americas, TeleGeography, Jun. 2020.

Developers will use 3GPP wireless technologies for many IoT applications. In other instances, developers will use local area technologies, such as Wi-Fi, Bluetooth Low Energy, and ZigBee. New Low-Power Wide-Area (LPWA) wireless technologies emerging specifically to support IoT include Ingenu, LoRa, and Sigfox. The low-power operation of some of these technologies, including LTE and NR, will permit battery operation over multiple years. Table 7 summarizes the various technologies.

**Table 7: Wireless Networks for IoT**

Technology	Coverage	Characteristics	Standardization/ Specifications
GSM/GPRS/EC-GSM-IoT	Wide area. Huge global coverage.	Lowest-cost cellular modems, risk of network sunsets. Low throughput.	3GPP
HSPA	Wide area. Huge global coverage.	Low-cost cellular modems. Higher power, high throughput.	3GPP
LTE	Global	Higher module cost but best coverage and highest performance. Voice option and mobility.	3GPP
LTE-M	Many operators in many countries.	Low module cost with long battery life and medium-level throughput. Voice option and mobility.	3GPP
LTE NB-IoT	Many operators in many countries.	Low module cost with long battery life and lower-level throughput. No voice and no mobility. Ideal for indoor applications.	3GPP
Wi-Fi	Local area.	High throughput, higher power.	IEEE
ZigBee	Local area.	Low throughput, low power.	IEEE
Bluetooth Low Energy	Personal area.	Low throughput, low power.	Bluetooth Special Interest Group
LoRa	Wide area. Emerging deployments.	Low throughput, low power. Unlicensed bands (sub 1 GHz, such as 900 MHz in the United States).	LoRa Alliance <sup>87</sup>

---

<sup>87</sup> For details, see LoRa Alliance. <https://www.lora-alliance.org/>.

Technology	Coverage	Characteristics	Standardization/ Specifications
Sigfox	Wide area. Emerging deployments.	Low throughput, low power. Unlicensed bands (sub 1 GHz such as 900 MHz in the United States).	Sigfox <sup>88</sup>
Ingenu (previously OnRamp Wireless)	Wide area. Emerging deployments.	Low throughput, low power. Using 2.4 GHz ISM band. Uses IEEE 802.15.4.	Ingenu <sup>89</sup>

Refer to the appendix section “Internet of Things and Machine to Machine” for additional details of LTE-based IoT solutions.

Security is of particular concern to both developers and users of IoT technology. An increasing amount of network-connected infrastructure will result in new security vulnerabilities that are being addressed by concerted effort from the industry.<sup>90</sup>

Cloud-based support platforms and standardized interfaces are essential for development and deployment of IoT applications. For example, the organization oneM2M has developed a service-layer architecture that can be embedded in hardware and software to simplify communications with application servers.<sup>91</sup>

To address device management, the Open Mobile Alliance has developed the LightweightM2M protocol.<sup>92</sup>

## Cellular V2X Communications

Using cellular technologies for vehicle communications will increase safety and eventually assist with autonomous driving. C-V2X is gaining momentum, including global trials that began in 2017, support from organizations such as the 5GAA Automotive Association (5GAA),<sup>93</sup> and initial deployment.<sup>94</sup> C-V2X is being designed to enable application-layer automotive standards, such as those from ETSI and the Society of Automotive Engineers.

---

<sup>88</sup> For details, see Sigfox. <https://www.sigfox.com/en>.

<sup>89</sup> For details, see Ingenu. <https://www.ingenu.com/>.

<sup>90</sup> For further insight, refer to the Ericsson white paper, *IoT Security*, Feb. 2017. <https://www.ericsson.com/assets/local/publications/white-papers/wp-iot-security-february-2017.pdf>.

<sup>91</sup> OneM2M home page: <http://onem2m.org/>.

<sup>92</sup> Open Mobile Alliance, “Lightweight M2M (LWM2M).” <https://www.omaspecworks.org/what-is-oma-specworks/iot/lightweight-m2m-lwm2m/>.

<sup>93</sup> Details at <http://5gaa.org/>.

<sup>94</sup> 5GAA, “Update on V2X Communications Deployment in North America,” May 2019. [https://5gaa.org/wp-content/uploads/2019/05/02.Update\\_on\\_C-V2X\\_communications\\_Deployment\\_in\\_North\\_America.pdf](https://5gaa.org/wp-content/uploads/2019/05/02.Update_on_C-V2X_communications_Deployment_in_North_America.pdf).

Cellular technology vehicle communication is an alternative to approaches such as Dedicated Short Range Communications (DSRC) based on standards that include IEEE 802.11p and 802.11bd (in development and intended to operate in 5.9 GHz and 60 GHz).

In Release 14, 3GPP specified cellular vehicle-to-X (C-V2X) communications for LTE with two complementary transmission modes: direct communications between vehicles and network communications. Release 15 added radio improvements through transmit diversity (cyclic delay diversity) and improved performance.

Direct communications use bands such as the Intelligent Transportation Systems (ITS) 5.9 GHz band, using the PC5 interface specified for LTE device-to-device communications, and will not require a Universal Integrated Circuit Card (UICC) SIM (USIM). By operating on different channels in the ITS band, direct cellular V2X will be able to co-exist with IEEE 802.11p, another automotive communications protocol. Communications modes include Vehicle-to-Vehicle (V2V), Vehicle-to-Infrastructure (V2I), and Vehicle-to-Person (V2P). In network communications mode, the system will use traditional cellular licensed spectrum.

C-V2X use cases include do-not-pass warnings, blind curve hazard warnings, road works warnings, blind intersection assistance, coordinated driving with intention sharing, coordinated trains of vehicles (platooning), bicyclist and pedestrian alerts, sensor sharing, left-turn assistance, and real-time infrastructure updates.

As C-V2X technology continues to evolve, 3GPP has introduced a 5G-based V2X system in Release 16: NR C-V2X.<sup>95</sup> This new 5G-based V2X system expands the supported use cases to advanced V2X applications, beyond the basic safety that was the focus of LTE-based V2X in Release 14 and 15. The advanced applications identified by 3GPP include vehicle platooning, extended sensors, advanced driving, and remote driving. NR C-V2X is designed to facilitate complex vehicle maneuvers, including negotiated intersection crossings and coordinated lane changes, by leveraging lower-latency communication, better positioning accuracy, and on-the-fly distance-based group formations. Situational awareness is enhanced through high-throughput sensor sharing from onboard cameras, radars, and LiDAR imagery; real-time updates of 3D High Definition Maps; and the ability to see “through” vehicles and around blind corners.

Like LTE-based V2X, the NR C-V2X allows direct communication mode (i.e. sidelink) between vehicles without relying on cellular network connectivity. This enables reliable V2X services, for example, coordinated driving, when inside or outside of 5G network coverage. The direct communication of NR C-V2X offers major enhancements in terms of new short-range features enabling advanced applications to complement the basic safety use cases.

NR V2X sidelink is designed to complement and seamlessly coexist with LTE V2X. The Release 16 design allows NR C-V2X to operate in LTE network deployments (under 4G coverage) and vice versa. Based on the service type of the V2X application, the NR C-V2X UE is able to determine the Radio Access Technology (RAT) Type to use (i.e. NR C-V2X sidelink or LTE V2X sidelink) and the corresponding Transmission Format (TxProfile) using configured policies. The combination of LTE V2X of Release 14/15 and NR C-V2X of Release 16 will provide a comprehensive 5G C-V2X solution covering both basic safety and advanced applications.

NR C-V2X sidelink, as depicted in Figure 36, brings several enhancements in the form of higher throughput, lower latency, enhanced reliability, and improved positioning, all of which are expected to enhance cooperative and autonomous driving. These enhancements would

---

<sup>95</sup> This section contributed by Qualcomm.



be achieved by leveraging functionalities of 5G NR such as OFDM-based air interface with wideband carrier support and scalable sub-carrier spacing, a flexible slot-based framework, and making demodulation reference signals (DMRS) a function of speed and advanced channel coding. Furthermore, NR C-V2X sidelink has support for sidelink time synchronization, allowing robust C-V2X operation even without GPS coverage.

**Figure 36: Release 16 V2X Capability<sup>96</sup>**

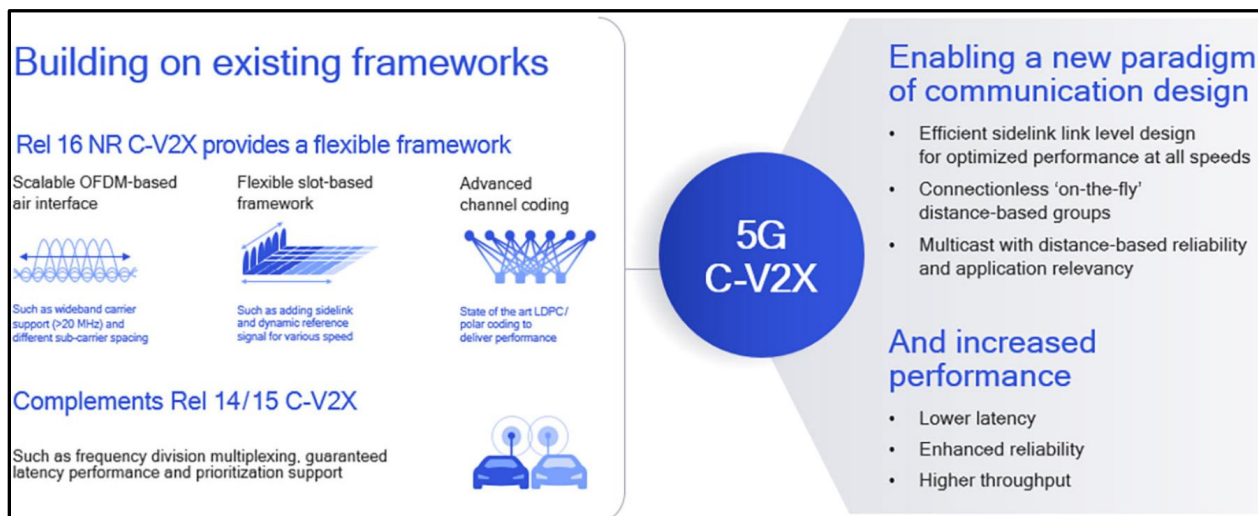

Recent field measurements have shown that V2X communications look promising in mmWave frequency bands despite vehicle blockage. Measurement results have shown that mmWave sidelink can support reasonably large coverage even without advanced beam-management procedures.<sup>97</sup>

Refer to the appendix section “C-V2X in Detail” for further information.

## Spectrum Developments

Scarcity of licensed spectrum continues to challenge the industry. Tactics to make the best use of this limited resource include:

- ❑ Deploying technologies that have higher spectral efficiency
- ❑ Adapting specifications to enable operation in all available bands
- ❑ Designing both FDD and TDD versions of technology to take advantage of both paired and unpaired bands
- ❑ Designing carrier aggregation techniques

<sup>96</sup> Qualcomm contribution. Further details at Qualcomm, “How NR-based sidelink expands 5G C-V2X to support new advanced use cases,” Mar. 31, 2020.

<https://www.qualcomm.com/news/onq/2020/03/31/how-nr-based-sidelink-expands-5g-c-v2x-support-new-advanced-use-cases>. See also Qualcomm, “C-V2X momentum and the future of smart mobility,” Jan. 7, 2020. <https://www.qualcomm.com/news/onq/2020/01/07/c-v2x-momentum-and-future-smart-mobility>.

<sup>97</sup> 3GPP, *Study on NR Vehicle-to-Everything (V2X)*, 3GPP TR 38.885, V16.0.0, Mar. 2019.

- ❑ Deploying as many new cells, large and small, as is economically and technically feasible

Although all of these industry initiatives greatly expand capacity, they do not obviate the need for additional spectrum. Fortunately, 5G technology will be able to employ frequencies not previously used in cellular systems, including 6 GHz to 100 GHz.

An important aspect of deployment is for infrastructure and mobile devices to accommodate the expanding number of available radio bands. The fundamental system design and networking protocols remain the same for each band; only the frequency-dependent portions of the radios must change. As other frequency bands become available for deployment, standards bodies adapt technologies for these bands as well. Although 5G is being designed to operate in all available bands, current GSM/HSPA/LTE technologies will most likely not be used beyond 3.5 GHz with licensed spectrum.

3GPP specified LTE for operation in many different bands, and initial use is more fragmented than the four bands (850 MHz, 900 MHz, 1.8 GHz, and 1.9 GHz) that enable global roaming on 2G and the additional two bands (1.7 GHz and 2.1 GHz) that enable 3G roaming. Operators are already re-farming 2G and 3G spectrum for LTE.

Mid-band frequencies from 3.3 GHz to 4.2 GHz are likely to become the global roaming bands for 5G.

The process of identifying new spectrum and making it available for the industry is a lengthy one, as shown in Figure 37.

**Figure 37: Spectrum Acquisition Time<sup>98</sup>**

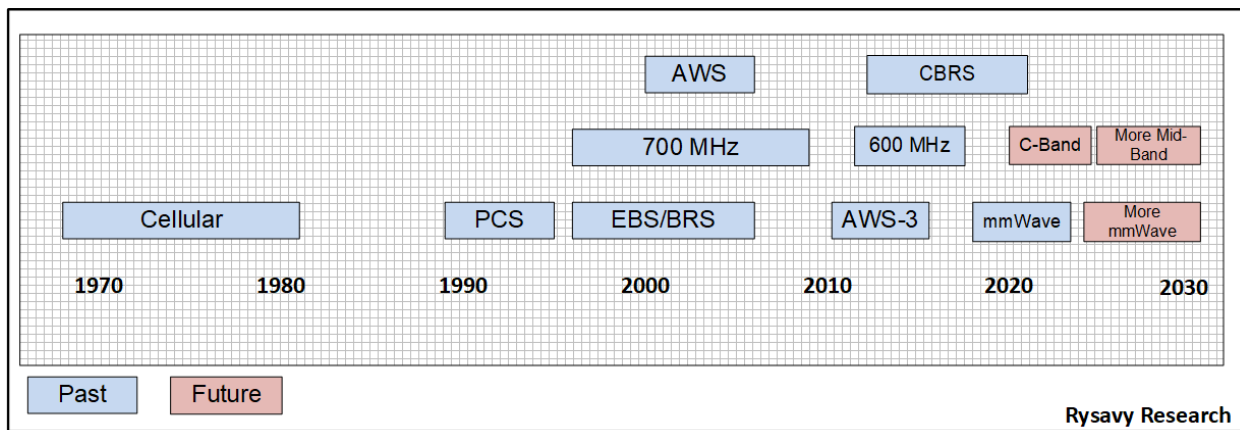

New spectrum in the United States includes Priority Access Licenses (PALs) in the CBRS band at 3.55 GHz, L-Band at 1.5 GHz, C-band at 3.7 GHz, and recently auctioned mmWave bands.

Table 8 summarizes current and future spectrum allocations in the United States.

<sup>98</sup> Source for historical data, FCC, *National Broadband Plan*, Chapter 5. <http://www.broadband.gov/plan/5-spectrum/>, accessed May 18, 2017. Future based on Rysavy Research analysis.

**Table 8: United States Current and Future Licensed Spectrum Allocations**

Frequency Band	Amount of Spectrum	Comments
600 MHz	70 MHz	Ultra-High-Frequency (UHF).
700 MHz	70 MHz	Ultra-High Frequency (UHF).
850 MHz	64 MHz	Cellular and Specialized Mobile Radio.
1.5/1.6 GHz (L-Band)	40 MHz	Available for 5G.
1.7/2.1 GHz	90 MHz	Advanced Wireless Services (AWS)-1.
1695-1710 MHz, 1755 to 1780 MHz, 2155 to 2180 MHz	65 MHz	AWS-3. Uses spectrum sharing.
1.9 GHz	140 MHz	Personal Communications Service (PCS).
2000 to 2020, 2180 to 2200 MHz	40 MHz	AWS-4 (Previously Mobile Satellite Service). <sup>99</sup>
2.3 GHz	20 MHz	Wireless Communications Service (WCS).
2.5 GHz	194 MHz	Broadband Radio Service. Closer to 160 MHz deployable. See also "2.5 GHz (EBS)" section below.
3.55-3.70 GHz CBRS	70 MHz	150 MHz underlay of generally authorized spectrum, with up to 70 MHz available for licensed use (40 MHz limit for a single operator in license area).
24 GHz	700 MHz	Second licensed mmWave spectrum in the United States.
28 GHz	850 MHz	First licensed mmWave spectrum in the United States.
37, 39, 47 GHz	4 GHz	Third licensed mmWave spectrum in the United States.
FUTURE		
3.7 to 4.2 GHz (C-band)	280 MHz	Auction planned for end of 2020 to license 3.7 to 3.98 GHz with C-band satellite services repacked in 4 to 4.2 GHz.
3.1 to 3.55 GHz	To be determined	Under investigation by FCC and National Telecommunications and Information Administration (NTIA), with upper 100 MHz recommended for commercial sharing.

The subsections below provide additional information about the recently completed incentive auction, the 3.5 GHz band, 5G, spectrum harmonization, unlicensed spectrum, and spectrum sharing.

<sup>99</sup> Supported in 3GPP Band 70, which adds 1995-2000 MHz, pairing it with 1695-1710 MHz in AWS-3 band.

### **3.55 to 3.70 GHz (CBRS)**

In the United States, the FCC is in the process of opening the 3550 to 3700 MHz CBRS band. Among the entities contemplating this band are cellular operators for small cells, wireless ISPs for service in cities and rural areas, and private entities for addressing their own applications. A private network could entail an enterprise with all of its own infrastructure, including spectrum, or alternatively an enterprise using spectrum it has licensed but with infrastructure managed by an operator.

The FCC is implementing a three-tier model with incumbent access, priority access with priority access licenses (PALs), and General Authorized Access (GAA) for lightly licensed users.<sup>100</sup> Incumbent access will include government radar systems.

Two industry organizations, the Wireless Innovation Forum<sup>101</sup> and the CBRS Alliance,<sup>102</sup> are working for the realization of 3.5 GHz systems. Originally intended for LTE technology, CBRS will also be available for 5G systems, with 5G specifications completed in February 2020.<sup>103</sup>

In 2019, the FCC finalized PAL rules using county-wide licensing areas. In January 2020, the FCC approved four commercial Spectrum Access Systems (SASs) to act as database managers, and entities were able to begin using the GAA tier.<sup>104</sup> The FCC scheduled the auction for CBRS PAL licenses to begin in July 2020.

See the section "Spectrum Sharing (CBRS, LSA)" for further details of how this band will be used.

### **3.7 to 4.2 GHz (C-Band)**

With momentum growing globally to use mid-band spectrum for 5G, the 3.7 to 4.2 GHz band will play a crucial role in rapid 5G deployment, especially given that mid-band spectrum requires significantly fewer cell sites to cover an area than using mmWave frequencies. Although mid-band deployments will not offer the capacity and potential peak throughputs possible with mmWave, they will, through extensive use of massive MIMO, offer a significant performance advantage over current cellular bands.

---

<sup>100</sup> For further details, see Official FCC Blog, "Innovation in the 3.5 GHz Band: Creating a New Citizens Broadband Radio Service," Mar. 2015. <http://www.fcc.gov/blog/innovation-35-ghz-band-creating-new-citizens-broadband-radio-service>. See also FCC, *Further Notice of Proposed Rulemaking--Amendment of the Commission's Rules with Regard to Commercial Operations in the 3550- 3650 MHz Band*, Apr. 23, 2014.

<sup>101</sup> See <http://www.wirelessinnovation.org/>.

<sup>102</sup> See <https://www.cbrcalliance.org/>.

<sup>103</sup> CBRS Alliance press release, "CBRS Alliance Opens Gates for First U.S. Mid-band 5G Deployments," Feb. 26, 2020. <https://www.cbrcalliance.org/news/cbrc-alliance-opens-gates-for-first-u-s-mid-band-5g-deployments/>.

<sup>104</sup> WinnForum, "CBRS Status Summary," <https://cbrc.wirelessinnovation.org/cbrc-status-summary>, viewed Apr. 7, 2020.

A Rysavy Research analysis in 2019 concluded that 5G needs a minimum of 300 MHz to make C-band viable and competitive with the rest of the world.<sup>105</sup>

In early 2020, the FCC stated it would proceed with a public auction of 280 MHz of the C-band beginning in December 2020.<sup>106</sup> Auction proceeds will help fund relocation of current satellite operators and other incumbents.

The FCC anticipates that under an accelerated timeframe, operators could deploy networks in the lower 100 MHz of the C-band in forty-six of the nation's top fifty Partial Economic Areas by September 2021 and in the remaining spectrum by September 2023.

Although an excellent start, based on rising global competition, 280 MHz of spectrum for 5G in C-Band will be insufficient. The United States led the world in LTE deployments during the 2010s, powering a mobile computing revolution that propelled many mobile computing-targeting U.S. companies to a leadership position. Similarly, countries leading in 5G network performance will benefit from a communications platform that, in combination with advances in technologies such as AI, will accelerate innovation.

Of particular concern is that many countries are moving faster than the United States in opening mid-band spectrum for 5G. A global spectrum report performed by Analysys Mason for CTIA concludes that relative to thirteen other markets, the United States is far behind in making licensed mid-band spectrum available.<sup>107</sup> The report expects that by the end of 2022, the following countries will have the following amounts of mid-band spectrum in this global range assigned:

- ❑ Canada 480 MHz
- ❑ China 460 MHz
- ❑ Hong Kong 460 MHz
- ❑ Japan 1000 MHz
- ❑ South Korea 600 MHz
- ❑ UK approximately 790 MHz
- ❑ United States 350 MHz (combination of 280 MHz in C-Band and 70 MHz in CBRS)
- ❑ Average across 14 listed countries 470 MHz

---

<sup>105</sup> Rysavy Research, "Untangling C-Band for a New Broadband Future," Fierce Wireless, Jan. 2019. <https://rysavysresearch.files.wordpress.com/2019/01/2019-01-untangling-c-band-new-broadband-future.pdf>.

<sup>106</sup> FCC, *The C-Band. Repurposing Mid-Band Spectrum for 5G*, Feb. 6, 2020. <https://docs.fcc.gov/public/attachments/DOC-362335A1.pdf>.

<sup>107</sup> Analysys Mason, *Final Report for CTIA, Mid-Band Spectrum Global Update*, Mar. 2020. <https://www.ctia.org/news/report-5g-mid-band-spectrum-global-update>.

The European Commission has announced it will harmonize spectrum in the 3.6 GHz band so that members states can use the spectrum by the end of 2020. It will also harmonize 5G in 700 MHz and 26 GHz bands.<sup>108</sup>

### **3.1 to 3.55 GHz**

Initiated by the U.S. Congress in the MOBILE NOW Act,<sup>109</sup> a review of the 3.1-3.55 GHz band is underway. The wireless industry is working with the FCC, NTIA, and the Department of Defense to explore freeing up additional amounts of federally used mid-band spectrum for commercial, licensed use. In support of this effort, the FCC issued a Notice of Proposed Rulemaking (NPRM) in 2019 to relocate non-federal users from the band.<sup>110</sup> 5G Americas filed comments and reply comments in response to the FCC's NPRM, encouraging the Commission to repurpose the 3.3–3.55 GHz band for commercial licensed services and to continue to review the rest of the lower 3 GHz band.<sup>111</sup>

In January 2020, NTIA issued an initial report on the technical feasibility of sharing federal spectrum in the 3.45 to 3.55 GHz band with commercial operations.<sup>112</sup> In April 2020, 5G Americas sent NTIA a letter advocating rapid evaluation of 3.1 to 3.45 GHz. In July 2020, NTIA issued a report assessing feasibility of commercial wireless services sharing with federal operations in the entire 3.1 to 3.55 GHz band.<sup>113</sup> NTIA recommended commercial sharing for the upper 100 MHz and stated in its executive summary, "Next steps will focus on the further work needed to enable potential sharing of the 3450-3550 MHz portion of the band, where near-term success is most likely, and to consider possible ways to increase commercial access to more of the 3100-3550 MHz range." In July 2020, 5G Americas responded to the NTIA report, saying, "Now that NTIA has issued its report on

---

<sup>108</sup> RCR Wireless, "Europe to harmonize spectrum in the 3.6 GHz band for future 5G services," Jan. 25, 2019. <https://www.rcrwireless.com/20190125/5g/europe-harmonise-spectrum-band-future-5g-services>.

<sup>109</sup> Congress.gov, *S.19 MOBILE NOW Act, 115th Congress (2017-2018)*, Aug. 3, 2017. <https://www.congress.gov/bill/115th-congress/senate-bill/19>.

<sup>110</sup> FCC, *Notice of Proposed Rulemaking, Facilitating Shared Use in the 3.1-3.55 GHz Band*, WT Docket No. 19-348, Dec. 16, 2019. <https://docs.fcc.gov/public/attachments/FCC-19-130A1.pdf>.

<sup>111</sup> 5G Americas, "5G Americas files reply comments in response to FCC's Notice of Proposed Rulemaking for 3.1-3.55 GHz band," Mar. 24, 2020. <https://www.5gamericas.org/5g-americas-comments-in-response-to-fccs-notice-of-proposed-rulemaking-for-3-1-3-55-ghz-band/>.

5G Americas, "5G Americas comments in response to FCC's Notice of Proposed Rulemaking (3.1-3.55 GHz)," Feb. 2020. <https://www.5gamericas.org/5g-americas-comments-in-response-to-fccs-notice-of-proposed-rulemaking-3-3-3-55-ghz/>

<sup>112</sup> NTIA, *Technical Feasibility of Sharing Federal Spectrum with Future Commercial Operations in the 3450-3550 MHz Band*, NTIA Technical Report 20-546. <https://www.its.bldrdoc.gov/publications/details.aspx?pub=3236>.

<sup>113</sup> NTIA, *Feasibility of Commercial Wireless Services Sharing with Federal Operations in the 3100-3550 MHz Band*, Jul. 2020. [https://www.ntia.doc.gov/files/ntia/publications/ntia\\_3100-3550\\_mhz\\_mobile\\_now\\_report\\_to\\_congress.pdf](https://www.ntia.doc.gov/files/ntia/publications/ntia_3100-3550_mhz_mobile_now_report_to_congress.pdf).

the full 3.1 - 3.55 GHz band, it is critical that the federal agencies work closely with industry at successful solutions to free up more spectrum in the band.”<sup>114</sup>

Additional spectrum in the lower 3 GHz band of at least 100 MHz, and preferably 250 MHz, will be critical for the success of 5G in the United States and for U.S. global competitiveness.

## **2.5 GHz (EBS)**

In 2019, the FCC issued a report and order with respect to the 2.5 GHz band (2496 MHz to 2690), with the goal of licensing block sizes of 16.5 MHz, 49.5 MHz, and 50.5 MHz.<sup>115</sup> The FCC stated that the report and order, “allows for more efficient and effective use of 2.5 GHz spectrum by increasing flexibility for existing EBS [Educational Based Services] licensees and providing new opportunities for rural Tribal Nations and other entities to access unused portions of the band.”<sup>116</sup>

## **6 GHz**

In April 2020, the FCC allocated an additional 1.2 GHz of spectrum for shared unlicensed spectrum, following through on a 2018 Notice of Proposed Rulemaking.<sup>117</sup> Historically in the United States, the FCC has allocated comparable amounts of spectrum for licensed and unlicensed spectrum, but as Rysavy Research argued, this allocation provided a disproportionate amount of spectrum for unlicensed both in lower bands and mmWave.<sup>118</sup>

## **5.850 to 5.925 GHz (DSRC)**

The 5.9 GHz band (5.850 to 5.925 GHz) in the United States has been allocated to Dedicated Short Range Communications, a service in the Intelligent Transportation System (ITS) service that has seen slow progress. In November 2019, the FCC issued an NPRM to examine the band and to propose changes, including dedicating the upper 30 MHz for ITS, permitting C-V2X operations in the upper 20 MHz (5.905 to 5.925 MHz), and repurposing the lower 45 MHz for unlicensed operations such as Wi-Fi.<sup>119</sup>

In March 2020, 5G Americas filed comments, emphasizing the importance of C-V2X communications, stating that the Notice, “does not allocate sufficient spectrum to enable

---

<sup>114</sup> 5G Americas, “5G Americas Urges NTIA to Move Quickly on Mid-Band Spectrum for Commercial Wireless Use,” Jul. 2020. <https://www.5gamericas.org/5g-americas-urges-ntia-to-move-quickly-on-mid-band-spectrum-for-commercial-wireless-use/>.

<sup>115</sup> FCC, Report and Order, *Transforming the 2.5 GHz Band*, WT Docket No. 18-120, Jul. 2019. <https://docs.fcc.gov/public/attachments/FCC-19-62A1.pdf>.

<sup>116</sup> FCC, “FCC Transforms 2.5 GHz Band for 5G Services,” <https://www.fcc.gov/document/fcc-transforms-25-ghz-band-5g-services-0>, viewed Apr. 7, 2020.

<sup>117</sup> FCC, Notice of Proposed Rulemaking, *Unlicensed Use of the 6 GHz Band*, Oct. 2018. <https://docs.fcc.gov/public/attachments/FCC-18-147A1.pdf>.

<sup>118</sup> Rysavy Research, “6 GHz should be allocated for both licensed and unlicensed applications,” Mar. 19, 2020. <https://rysavyresearch.files.wordpress.com/2020/03/2020-03-6ghz-licensed-unlicensed.pdf/>.

<sup>119</sup> FCC, Notice of Proposed Rulemaking, *Use of the 5.850-5.925 GHz Band*, ET Docket No. 19-138, Nov. 21, 2019. <https://docs.fcc.gov/public/attachments/DOC-360940A1.pdf>.

deployment of 5G-based C-V2X PC5<sup>120</sup>, and proposing the rest of the band be allocated for that technology instead of unlicensed operations.”<sup>121</sup>

## **5G mmWave Bands**

As radio technology progresses, it can handle higher frequencies, and it occupies greater bandwidth. 1G systems used 30 kHz radio carriers, 2G in GSM uses 200 kHz carriers, 3G in UMTS uses 5 MHz carriers, and 4G in LTE uses carriers of up to 20 MHz each and up to 640 MHz through carrier aggregation. 3GPP is specifying 5G NR to have individual radio carriers of up to 100 MHz wide in sub-6 GHz bands and up to 400 MHz in mmWave bands. Carrier aggregation will allow even wider usage of spectrum. In mmWave bands, ten times as much spectrum, or more, will eventually become available than in all currently licensed cellular spectrum—600 MHz to 2.5 GHz.

3GPP is specifying 5G NR to be band agnostic. 5G will use low-, mid-, and high-band spectrum. 3GPP Technical Services Group - Radio Access Networks (TSG-RAN) agreed to a process of efficiently adding LTE/NR band combinations and carrier-aggregated NR/NR band combinations. See the appendix section “Spectrum Bands (3G to 5G)” for a listing of 5G bands. Just as 3GPP has done with LTE, over time, 3GPP will specify additional 5G bands spanning multiple frequencies.

During the 2019 World Radiocommunication Conference (WRC-19), the ITU identified these mmWave band frequencies for International Mobile Telecommunication (IMT), which can include 5G: 24.25-27.5 GHz, 37-43.5 GHz, 45.5-47 GHz, 47.2-48.2 GHz, and 66-71 GHz.<sup>122</sup>

In January 2019, the FCC completed the auction of the 28 GHz band, licensing 850 MHz, and in May 2019, the FCC completed the auction of the 24 GHz band, licensing 700 MHz. In March 2020, the FCC completed its third auction of mmWave bands for licenses in the 37, 39, and 47 GHz bands.<sup>123</sup> The 37 GHz and 39 GHz bands will offer the largest amount of contiguous mmWave spectrum for flexible-use, 2400 MHz. The 47 GHz will provide 1,000 MHz.

In March 2019, the FCC’s Spectrum Horizons First Report and Order created a new category of experimental licenses from 95 GHz to 3 THz, freeing up to 21.2 GHz for unlicensed use in the 116-123 GHz band, the 174.8-182 GHz band, the 185-190 GHz

---

<sup>120</sup> C-V2X direct communications. See the section “Cellular V2X Communications” for further details.

<sup>121</sup> 5G Americas, “5G Americas comments in response to FCC’s Notice of Proposed Rulemaking for 5.850-5.925 MHz (“5.9 GHz”) Band,” Mar. 9, 2020. <https://www.5gamericas.org/5g-americas-comments-in-response-to-fccs-notice-of-proposed-rulemaking-for-5-850-5-925-mhz-5-9-ghz-band/>.

<sup>122</sup> ITU, *World Radiocommunication Conference 2019 (WRC-19), Provisional Final Acts*, 2019. [https://www.itu.int/dms\\_pub/itu-r/opb/act/R-ACT-WRC.13-2019-PDF-E.pdf](https://www.itu.int/dms_pub/itu-r/opb/act/R-ACT-WRC.13-2019-PDF-E.pdf). See also, IEEE, “WRC 19 Wrap-up: Additional spectrum allocations agreed for IMT-2020 (5G mobile),” <https://techblog.comsoc.org/2019/11/22/wrc-19-wrap-up-additional-spectrum-allocations-agreed-for-imt-2020-5g-mobile/>.

<sup>123</sup> FCC, *Fourth Report and Order, Use of Spectrum Bands Above 24 GHz for Mobile Radio Services*, Dec. 12, 2018. <https://www.microwavejournal.com/ext/resources/blogs/Gary/2018/FCC-18-180A1.pdf>.



band, and the 244-246 GHz band.<sup>124</sup> 5G America filed comments in May 2019, stating that with “continued investment in research and development by the wireless industry, 5G Americas believes 95 GHz and above will prove to be appropriate for exclusively-licensed use.”<sup>125</sup>

Although behind other countries in making mid-band spectrum available for 5G, the United States leads in licensing mmWave bands. Other countries that licensed mmWave frequencies for 5G deployments in 2019 include South Korea (28 GHz), Japan (28 GHz), Italy (26 GHz), Russia (26 GHz), and Germany (26 GHz).<sup>126</sup>

The European Union is requiring Member States to harmonize their regulations for 5G operation in 26 GHz by December 31, 2020.<sup>127</sup>

Table 9 summarizes the United States 5G bands for the near future.

**Table 9: United States 5G mmWave Bands<sup>128</sup>**

Bands	Details
24 GHz Band (24.25-24.45 GHz and 24.75-25.25 GHz)	Licensed in seven 100 MHz blocks.
28 GHz Band (27.5-28.35 GHz)	Licensed in two 425 MHz blocks by county.
39 GHz Band (38.6-40 GHz)	Licensed in 100 MHz blocks.
37 GHz Band (37-38.6 GHz)	Lower 37-37.6 GHz segment shared between federal and non-federal users. Upper 37.6-38.6 GHz segment licensed in 100 MHz blocks.
47 GHz Band (47.2-48.2 GHz)	Licensed in 100 MHz blocks.
64-71 GHz Band	Available for unlicensed use with same Part 15 rules as existing 57-64 GHz band.

<sup>124</sup> FCC, *First Report and Order, Spectrum Horizons*, Mar. 21, 2019. <https://docs.fcc.gov/public/attachments/FCC-19-19A1.pdf>.

<sup>125</sup> 5G Americas, “5G Americas FCC filing for consideration of more exclusive use licensed spectrum 95 GHz and above,” <https://www.5gamericas.org/fcc-filing-for-consideration-of-more-exclusive-use-licensed-spectrum-95-ghz-and-above/>.

<sup>126</sup> For additional details, refer to GSA (Global Mobile Supplier Association), *Spectrum for Terrestrial 5G Networks: Licensing Developments Worldwide*, Jul. 2019. <http://comitatomcs.eu/wp-content/uploads/2019/08/190730-GSA-5G-spectrum-report-July.pdf>.

<sup>127</sup> Venture Beat, “EU picks 26GHz for 5G millimeter wave, requires support by end of 2020,” May 15, 2020. <https://venturebeat.com/2019/05/15/eu-picks-26ghz-for-5g-millimeter-wave-requires-support-by-end-of-2020/>.

<sup>128</sup> For more details, refer to FCC, *Report and Order and Further Notice of Proposed Rulemaking, Use of Spectrum Bands Above 24 GHz for Mobile Radio Services*, Jul. 14, 2016. See also 5G Americas, *Spectrum Landscape for Mobile Services*, Nov. 2017. [http://www.5gamericas.org/files/8415/1018/3549/5G\\_Americas\\_Whitepaper\\_Spectrum\\_Landscape\\_F\\_or\\_Mobile\\_Services.pdf](http://www.5gamericas.org/files/8415/1018/3549/5G_Americas_Whitepaper_Spectrum_Landscape_F_or_Mobile_Services.pdf).

## Spectrum Sharing (CBRS, LSA)

In 2012, President Obama’s Council of Advisors on Science and Technology (PCAST) issued a report titled, “Realizing the Full Potential of Government-Held Spectrum to Spur Economic Growth.” The PCAST report recommended spectrum sharing between government and commercial entities.

The U.S. government can designate spectrum for exclusive, shared, or unlicensed use, as shown in Figure 38. Shared use can be opportunistic, as with TV white spaces; two-tier with incumbents and licensed users; or three-tier, which adds opportunistic access. The bands initially targeted for spectrum sharing include AWS-3 (two tiers on a temporary basis) and the 3.5 GHz CBRS band (three tiers).

The three-tier plan envisioned by the U.S. government for the 3.5 GHz band gives more entities access to the spectrum but at the cost of increased complexity.

**Figure 38: Spectrum Use and Sharing Approaches<sup>129</sup>**

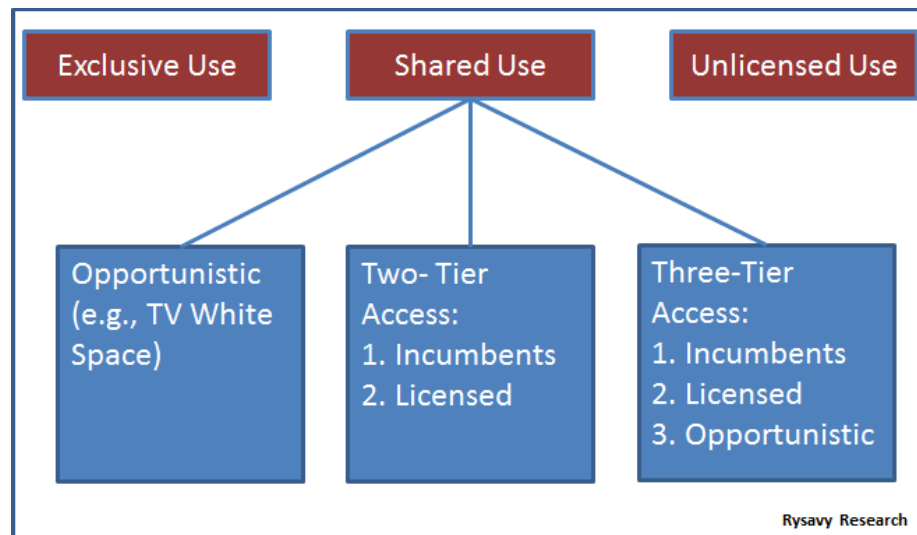

Figure 39 shows the architecture of the 3.5 GHz CBRS system. The system consists of incumbents (government systems), Priority Access Licenses, and General Authorized Access. Government systems include military ship-borne radar, military ground-based radar, fixed satellite service earth stations (receive-only), and government broadband services (3650 to 3700 MHz). GAA users are licensed “by rule” (complying with general regulations as opposed to operating under individually obtained licenses) and must protect both incumbents and PALs. Government radar incumbents are protected by an Environmental Sensing Capability (ESC) that detects incumbents and informs the SAS. Some examples of GAA use cases are small-business hotspots, campus hotspots, and backhaul.

Citizens Broadband Radio Service Devices (CBSDs) are the base stations operating under this service; they can operate only under the authority and management of the SAS, either by direct communications or a proxy node.

<sup>129</sup> TV White Space are under FCC Unlicensed Part 15 rules, Subpart H.

WinnForum has developed baseline specifications for operation within the CBRS band. To ensure interoperability, the CBRS Alliance has developed a certification program for equipment operating in the 3.5 GHz band and an associated brand named "OnGo."<sup>130</sup>

With completion of specifications in early 2020, CBRS can now support both LTE and 5G radio access.<sup>131</sup>

Use cases for CBRS include:

- ❑ Capacity extension for cellular operators.
- ❑ Fixed wireless access from commercial network providers, including cellular operators, regional/local ISPs, and cable companies. Rural operators may be able to take advantage of GAA.
- ❑ Private LTE and 5G networks.<sup>132</sup>

Operators will use CBRS with either GAA or PAL. For GAA, an operator can use LAA with a licensed band carrier aggregated with the GAA unlicensed band. A private enterprise could also use GAA or PAL, deploying either its own core network or working in partnership with an operator. An enterprise deployment could support roaming with cellular networks.

Recently-completed NR-U specifications will provide even greater flexibility. For example, a CBRS band could serve as an anchor and be combined with NR in an unlicensed band.<sup>133</sup>

Potential private network use cases include retail sales, video surveillance, communications for security and operations teams, mobile point-of-sale and mobile kiosks, manufacturing and industrial automation, transportation and logistics, energy and utilities, healthcare, automated vehicles, and equipment control.

---

<sup>130</sup> For details, see CBRS Alliance, "OnGo Certification" at <https://www.cbrsalliance.org/certification/>.

<sup>131</sup> Fierce Wireless, "CBRS Alliance completes 5G specs," Feb. 26, 2020. <https://www.fiercewireless.com/tech/cbrs-alliance-completes-5g-specs>.

<sup>132</sup> For further discussion of use cases, see Ericsson, "How CBRS spectrum changes the game for wireless industry innovation in the US," Feb. 26, 2020. <https://www.ericsson.com/en/blog/6/2020/the-fuss-about-cbrs>.

<sup>133</sup> Qualcomm, "How does support for unlicensed spectrum with NR-U transform what 5G can do for you?" Jun. 11, 2020. <https://www.qualcomm.com/news/onq/2020/06/11/how-does-support-unlicensed-spectrum-nr-u-transform-what-5g-can-do-you>.

**Figure 39: CBRS Architecture**

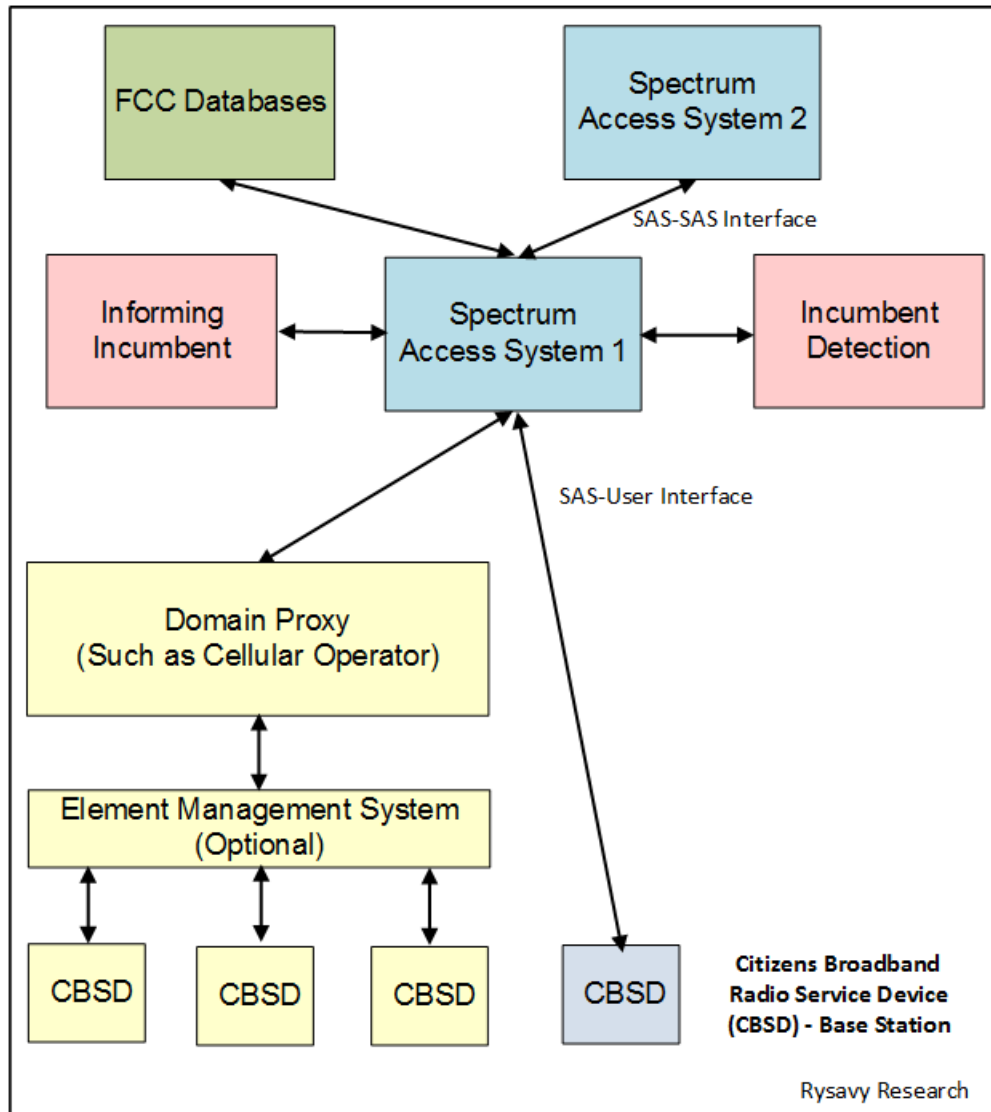

The European Telecommunications Standards Institute (ETSI) is the leading organization standardizing cognitive radios. The most relevant effort is Licensed Shared Access (LSA), a two-tier spectrum sharing system that includes incumbents and licensed secondary users that access shared spectrum via a database, as depicted in Figure 40.

**Figure 40: Licensed Shared Access (LSA)**

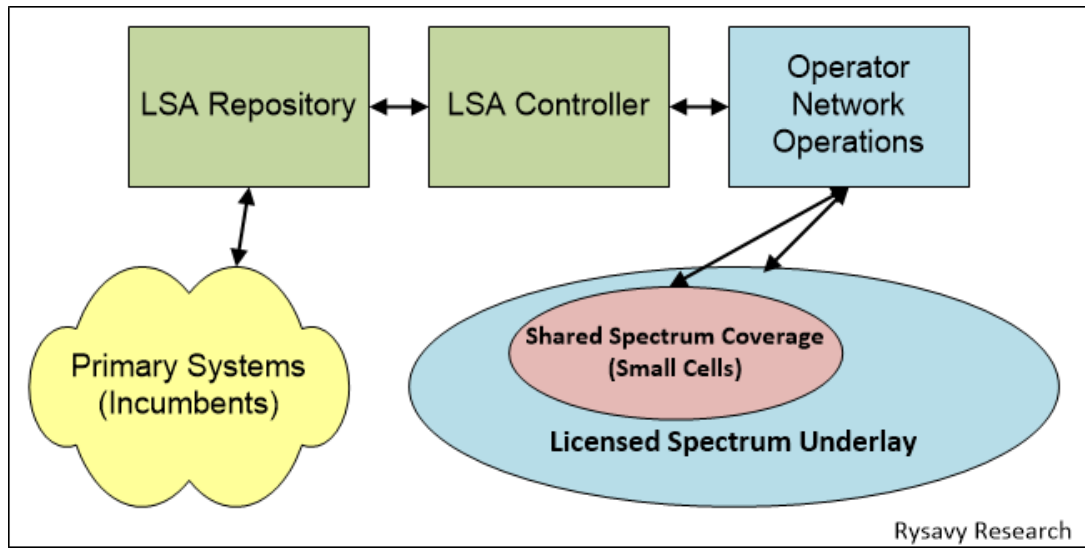

## **Harmonization**

Spectrum harmonization delivers many benefits, including higher economies of scale, better battery life, improved roaming, and reduced interference along borders.

As regulators make more spectrum available, it is important that they follow guidelines such as those espoused by 5G Americas:<sup>134</sup>

- ❑ Configure licenses with wider bandwidths.
- ❑ Group like services together.
- ❑ Be mindful of global technology standards.
- ❑ Pursue harmonized/contiguous spectrum allocations.
- ❑ Exhaust exclusive use options before pursuing shared use.
- ❑ Because not all spectrum is fungible, align allocation with demand.

LTE and 5G NR benefit from wider radio channels. These wider channels are not only spectrally more efficient, they also offer greater capacity. Figure 41 shows increasing LTE spectral efficiency obtained with wider radio channels, with 20 MHz on the downlink and 20 MHz (20+20 MHz) on the uplink comprising the most efficient configuration.

---

<sup>134</sup> 4G Americas, *Sustaining the Mobile Miracle – A 4G Americas Blueprint for Securing Mobile Broadband Spectrum in this Decade*, Mar. 2011.

**Figure 41: LTE Spectral Efficiency as Function of Radio Channel Size<sup>135</sup>**

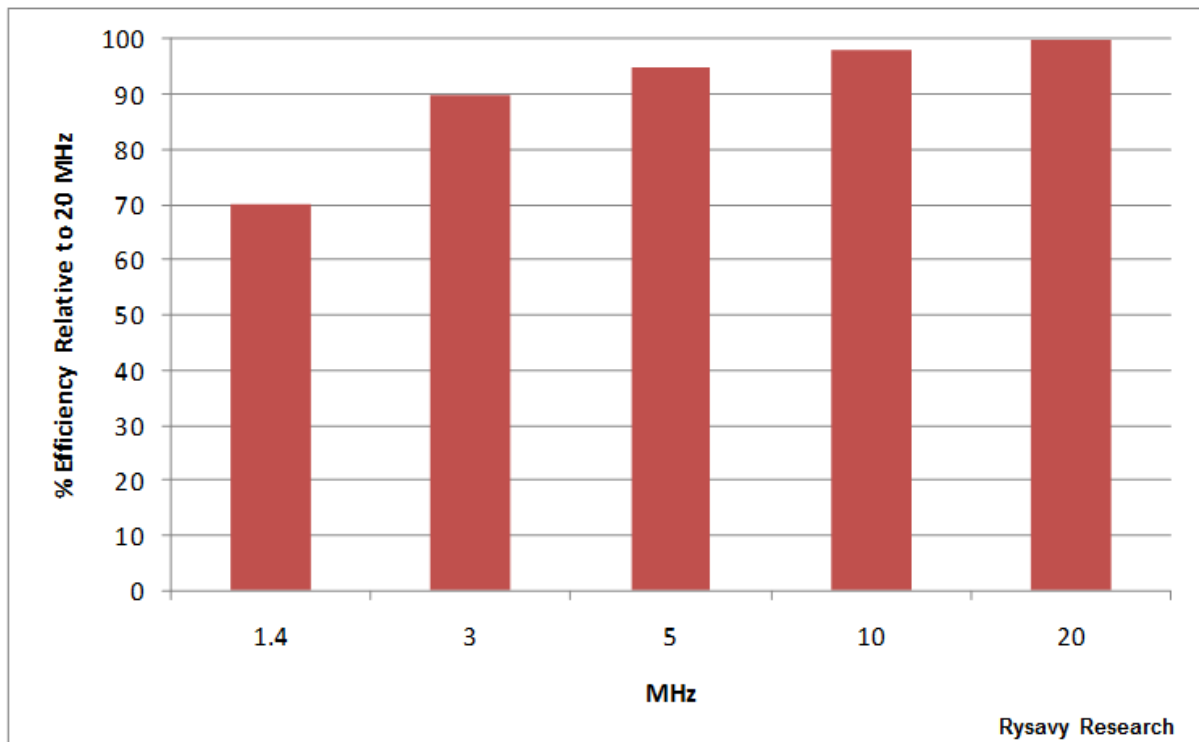

The organization tasked with global spectrum harmonization, the International Telecommunication Union, periodically holds World Radiocommunication Conferences.<sup>136</sup>

Harmonization occurs at multiple levels:

- ❑ Allocation of radio frequencies to a mobile service in the ITU frequency allocation table.
- ❑ Establishment of global or regional frequency arrangements, including channel blocks and specific duplexing modes.
- ❑ Development of detailed technical specifications and standards, including system performance, RF performance, and coexistence with other systems in neighboring bands.
- ❑ Assignment for frequency blocks with associated technical conditions and specifications to appropriate operators and service providers.<sup>137</sup>

---

<sup>135</sup> 5G Americas member company analysis.

<sup>136</sup> International Telecommunication Union, "World Radiocommunication Conferences (WRC)," <http://www.itu.int/ITU-R/index.asp?category=conferences&mlink=wrc&lang=en>, viewed May 18, 2017.

<sup>137</sup> International Telecommunication Union Radiocommunication Study Groups, *Technical Perspective on Benefits of Spectrum Harmonization for Mobile Services and IMT*, Document 5D/246-E, Jan. 2013.

## Unlicensed Spectrum

Wi-Fi uses spectrum efficiently because its small coverage areas result in high-frequency reuse and high data density (bps per square meter). Less efficient are white-space unlicensed networks, sometimes called “super Wi-Fi,” that, because of large coverage areas, have much lower throughput per square meter. While white-space networks may be a practical broadband solution in rural or undeveloped areas, they face significant challenges in urban areas that already have mobile and fixed broadband available.<sup>138</sup>

Advocates argue that unlicensed spectrum unleashes innovation and that government should allocate greater amounts of unlicensed spectrum. Although Wi-Fi has been successful, the core elements that make unlicensed spectrum extremely successful are also the source of inherent disadvantages: local coverage and its unlicensed status. Local coverage enables high data density and high frequency reuse but makes widespread continuous coverage almost impossible. Similarly, unlicensed operation facilitates deployment by millions of entities but results in overlapping coverage and interference.

Of concern is the relative amount of licensed spectrum compared to unlicensed spectrum. 5G Americas states, “When compared with the total allocation of licensed spectrum for mobile networks, the amount of unlicensed spectrum is significantly greater.”<sup>139</sup>

Networks built using unlicensed spectrum cannot replace networks built using licensed spectrum, and vice versa. The two are complementary to each other, as summarized in Table 10.<sup>140</sup>

**Table 10: Pros and Cons of Unlicensed and Licensed Spectrum**

Unlicensed Spectrum		Licensed Spectrum	
Pros	Cons	Pros	Cons
Easy and quick to deploy	Potential of other entities using same frequencies	Huge coverage areas	Expensive infrastructure
Low-cost hardware	Difficult to impossible to provide wide-scale coverage	Able to manage quality of service	Each operator has access to only a small amount of spectrum

Some operators offer a “Wi-Fi first” capability with which devices always attempt to use a Wi-Fi connection and fall back to a cellular connection only if no Wi-Fi is available. Such cellular backup is essential because Wi-Fi, due to low-power operation in many bands, is inherently unsuited for providing continuous coverage. The sharp drop-off in signal

<sup>138</sup> For further analysis, see Rysavy Research, “White spaces networks are not ‘super’ nor even Wi-Fi,” Gigaom, Mar. 2013. <http://gigaom.com/2013/03/17/white-spaces-networks-are-not-super-nor-even-wi-fi/>.

<sup>139</sup> 5G Americas, *5G Spectrum Vision*, Feb. 2019. [http://www.5gamericas.org/files/4015/4958/3330/5G\\_Americas\\_5G\\_Spectrum\\_Vision\\_Whitepaper.pdf](http://www.5gamericas.org/files/4015/4958/3330/5G_Americas_5G_Spectrum_Vision_Whitepaper.pdf).

<sup>140</sup> For further analysis, see Rysavy Research, “It’s Time for a Rational Perspective on Wi-Fi,” Gigaom, Apr. 2014. <http://gigaom.com/2014/04/27/its-time-for-a-rational-perspective-on-wi-fi/>.

strength due to low transmit power makes coverage gaps over large areas inevitable, especially outdoors.

## Key Supporting Technologies

Network architects design networks using a broad toolkit, including AI, multiple cell types and sizes, integration with unlicensed spectrum, smart antennas, converged services, and virtualization.

### ***Virtualization and Cloud Native***

Virtualization refers to implementing the functions of infrastructure nodes in software on commercial “off-the-shelf” computing equipment. The approach promises lower capital expenditures, lower operating costs, faster deployment of new services, energy savings, and improved network efficiency. With NFV, multiple tenants will be able to share the same infrastructure, facilitating, for example, mobile virtual network operator (MVNO) and multi-operator virtualized RAN arrangements. NFV, however, also constitutes an entirely new way of building and managing networks, so widespread adoption will occur over a long period.

Both the core network and portions of the radio-access network can be virtualized. The core network, consisting of fewer nodes, is an easier starting point. Virtualizing RAN elements, although more complex, will eventually provide the greatest network efficiency gains, particularly for small-cell deployments where it can facilitate coordination among cells and use of methods such as CoMP and interference coordination. Unlike the core, virtualizing the entire RAN is not possible because a Physical Network Function must terminate the radio interface.

A number of industry efforts are facilitating the deployment of virtualized architectures. These efforts include work by 3GPP, the O-RAN Alliance, Common NFVi Telecom Taskforce (CNTT), Linux Foundation, and the Open Network Automation Platform (ONAP) project.

These open interfaces enable many radio and network functions to be implemented in software and create an interoperable vendor ecosystem.

The European Telecommunications Standards Institute (ETSI) is standardizing an NFV framework, including interfaces and reference architectures.<sup>141</sup> Other standards and industry groups involved include 3GPP, Cloud Native Computing Foundation, the Open Networking Foundation, OpenStack, OpenDaylight, OPNFV, and Open vSwitch.

Figure 42 shows the ETSI framework, in which virtualized network functions are the nodes or applications by which operators build services.

---

<sup>141</sup> For details, refer to ETSI, “Industry Specification Group (ISG) Network Functions Virtualisation,” <https://www.etsi.org/committee/nfv>.



**Figure 42: ETSI NFV High-Level Framework<sup>142</sup>**

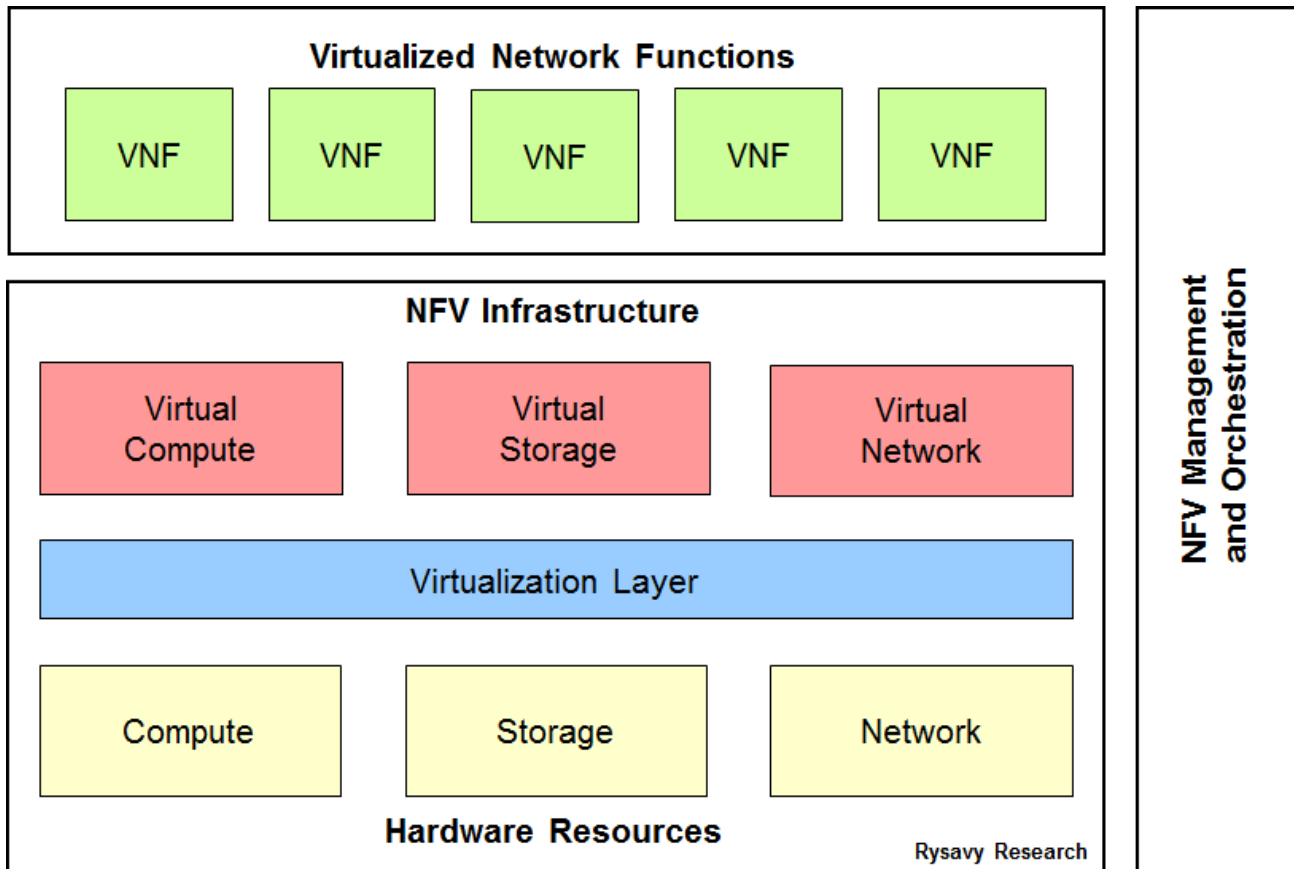

Some specific use cases for NFV include:

- ❑ **5G.** 5G networks are designed with interfaces that facilitate virtualized implementations.
- ❑ **IMS and VoLTE.** IMS is necessary for VoLTE, but an NFV approach could reduce the complexity associated with the multiple nodes and interfaces in the IMS architecture.
- ❑ **Virtualized EPC (VEPC).** The Evolved Packet Core, consisting of the Serving Gateway (SGW), the Packet Gateway (PGW), and Mobile Management Entity (MME), can be virtualized, but doing so will require meeting operator bandwidth, latency, and control plane service requirements.
- ❑ **New VEPC Services.** With a virtualized EPC, an operator can more easily create MVNO services, each with its own virtualized MME, SGW, and PGW. An M2M virtualized service is another example of offering a more finely tuned service for the target application. Because the PGW connects to external networks, further opportunities exist for virtualized services to augment networking functions,

<sup>142</sup> ETSI, *ETSI NFV High-Level Framework*, ETSI GS NFV 002 V1.1.1 (2013-10).

including video caching, video optimization, parental controls, ad insertion, and firewalls.

- ❑ **Cloud RAN.** Pooling of baseband processing in a cloud RAN can, but does not necessarily, use virtualization techniques. Separating the radio function from baseband processing typically requires transporting digitized radio signals across high-bandwidth (multi-Gbps) fiber connections, sometimes referred to as fronthauling. Refer to the appendix section “Cloud Radio-Access Network (RAN) and Network Virtualization” for a more detailed technical discussion.<sup>143</sup>

## Cloud Native

Related to virtualization are cloud native networks based on containerized network functions (CNFs). CNFs are similar to virtual network functions (VNFs), but they operate on lighter-weight containers, resulting in easier deployment than virtual machines (VMs).

A motivation for cloud native comes from the Service Based Architecture used in 5G, defined in Release 15, and enhanced in Release 16 to extend the service concept from the control plane to the user plane function. Although cloud native functions provide flexibility by breaking up existing network functions into microservices, a cloud native approach struggles to address the packet processing and latency requirements of 5G.<sup>144</sup>

Additional challenges for cloud native are developments occurring outside of 3GPP. For instance, 3GPP defines a VNF manager but not a CNF manager. No end-to-end standardization currently exists for cloud native architectures, and the resulting vendor implementation differences complicate interoperability between them. Nevertheless, cloud native is a likely industry direction as an evolution of SDN and NFV approaches.

Operators proceeding with cloud native architectures, including those based on frameworks from the Common NFVi Telco Taskforce,<sup>145</sup> are likely to use Kubernetes,<sup>146</sup> an open-source system for automating deployment, scaling, and management of containerized applications.<sup>147</sup>

Many different industry and standards organizations are involved in defining cloud-based network architectures, many of them open source, as shown in Figure 43.

---

<sup>143</sup> For further details, see “Network Functions Virtualisation,” <http://www.etsi.org/technologies-clusters/technologies/nfv>.

<sup>144</sup> For a detailed discussion of cloud native, refer to the 5G Americas white paper, *5G and the Cloud*, Dec. 2019. <https://www.5gamericas.org/5g-and-the-cloud/>.

<sup>145</sup> Fierce Telecom, “Common NFVi Telco Task Force publishes reference model and reference architecture for unified framework,” Sep. 23, 2020. <https://www.fiercetelecom.com/telecom/common-nfvi-telco-task-force-publishes-first-reference-model-and-reference-architecture-for>.

<sup>146</sup> Fierce Wireless, “Rakuten’s 5G network will be built with containers,” Apr. 10, 2020, <https://www.fiercewireless.com/5g/rakuten-s-5g-network-will-be-built-containers>.

<sup>147</sup> Light Reading, “AT&T Inks '8-Figure' Kubernetes & OpenStack 5G Deal With Mirantis,” Feb. 7, 2019, <https://www.lightreading.com/mobile/5g/atandt-inks-8-figure-kubernetes-and-openstack-5g-deal-with-mirantis/d/d-id/749318>.

**Figure 43: Linux Foundation Open Networking and Orchestration<sup>148</sup>**

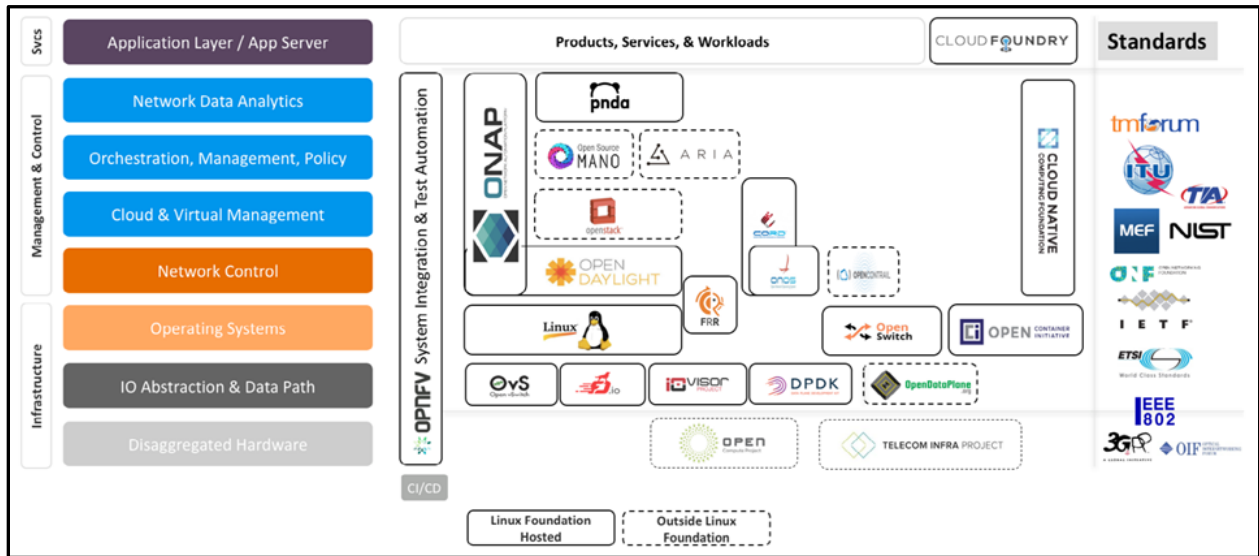

## O-RAN

O-RAN transforms the radio access network by breaking up radio processing into a combination of distributed and centralized functions with well-defined interfaces between them and extending to other parts of the network. This approach makes it possible for vendors to concentrate on portions of the network in which they have greatest expertise, while the smaller pieces involved allow lower barriers to entry, thus broadening vendor diversity.

A related effort is the Telecom Infra Project (TIP) OpenRAN.<sup>149</sup> The TIP OpenRAN project and O-RAN Alliance agreed in 2020 to align their work in developing interoperable, disaggregated RAN solutions.<sup>150</sup> While TIP does not develop specifications, it develops use cases, performs laboratory validation, helps develop the ecosystem for vendors and operators, and facilitates trials. Yet another organization, the OpenRAN Policy Coalition,<sup>151</sup> promotes policies to advance the adoption of open and interoperable RAN solutions.

Another concept is vRAN, which does not involve standardization or interoperability, but focuses on how to implement the RAN in a virtualized environment on open hardware. One can think of vRAN as vertical openness and O-RAN interfaces as horizontal openness. An open RAN (one built using open interfaces) does not necessarily have to be virtualized,

<sup>148</sup> Linux Foundation, *Harmonizing Open Source and Standards in the Telecom World*, May 2017. <https://www.linuxfoundation.org/publications/2017/05/new-networking-harmonization/>

<sup>149</sup> Heavy Reading, TIP OpenRAN: Toward Disaggregated Mobile Networking, May 2020. <https://img.lightreading.com/downloads/TIP-OpenRAN-Toward-Disaggregated-Mobile-Networking.pdf>.

<sup>150</sup> IEEE ComSoc Technology Blog, "TIP OpenRAN and O-RAN Alliance liaison and collaboration for Open Radio Access Networks," Feb. 26, 2020. <https://techblog.comsoc.org/2020/02/26/tip-openran-and-o-ran-alliance-liaison-and-collaboration-for-open-radio-access-networks/>.

<sup>151</sup> <https://www.openranpolicy.org/>.

although many will be. Similarly, a closed RAN with proprietary or vendor-specific interfaces can still be virtualized.

Figure 44 depicts the combined NFVi and O-RAN architecture, premised on:

- ❑ A generic RF architecture for lower power radio access points.
- ❑ Commodity small cells hardware.
- ❑ Standardized fronthaul allowing a split between the Remote Radio Unit and Centralized Processing.
- ❑ Standardized mid-haul interface between real-time (Distributed Units) and near-real-time (Centralized Units) for radio processing.
- ❑ RAN Intelligent Controller, specified by O-RAN, which provides network intelligence for policy enforcement, QoS management, handover optimization, self-organization, load balancing, and slicing control.

**Figure 44: O-RAN Architecture**

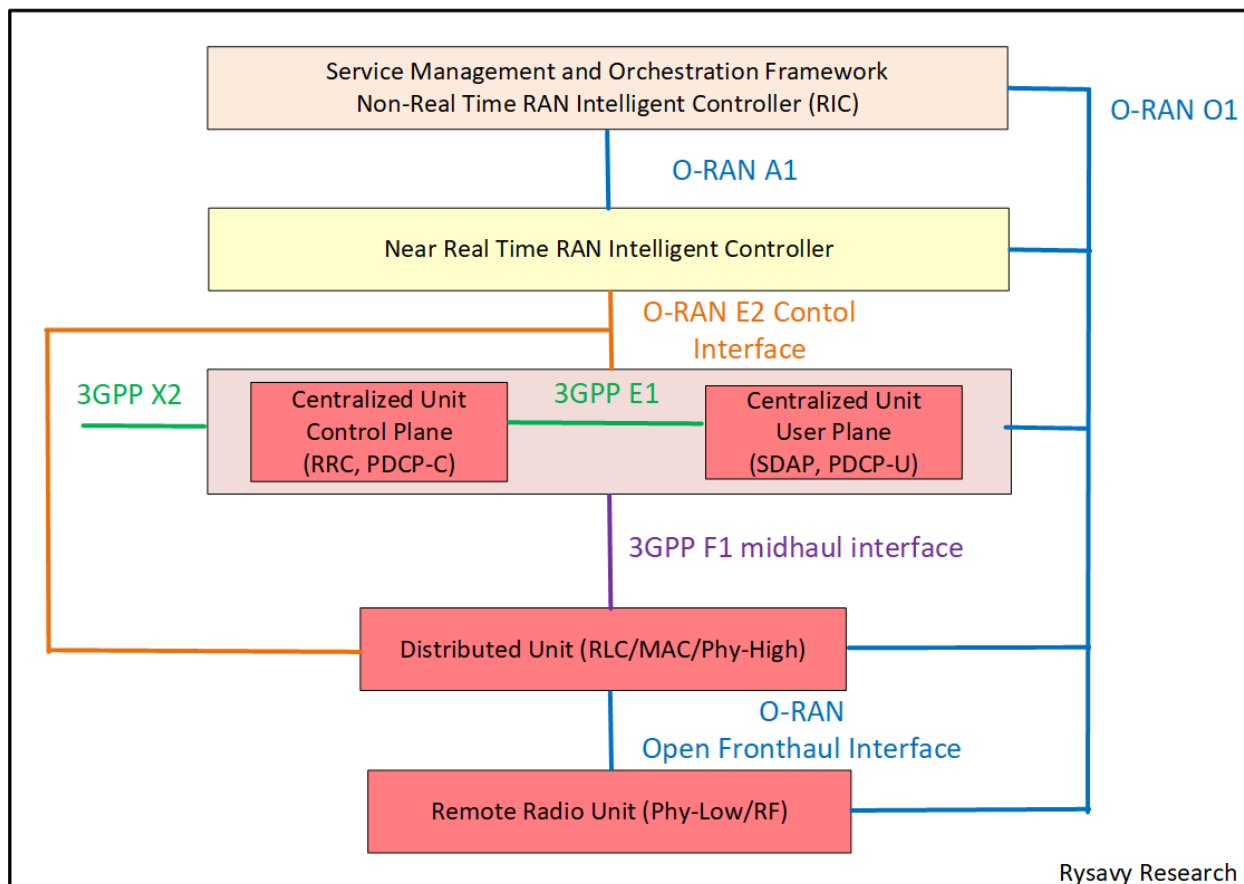

The O-RAN Alliance has specified the details of the connection between the Distributed Unit (DU) and the Remote Radio Unit based on what is called Option 7-2x. The scope of specifications includes Control-plane, User-plane, Synchronization-plane, and Management-plane protocol structure, as well as procedures for interoperability between the radio unit and DU. O-RAN uses the Enhanced Common Public Radio Interface (eCPRI)

or optional Radio over Ethernet (RoE) as the transport protocol over Ethernet, or optional IP/UDP encapsulation for control and user plane protocol. The S-plane protocol is defined as Precision Time Protocol (PTP) over Ethernet with optional Synchronous Ethernet support.

Lower layer functional split Option 7-2x allows two types of radios based on the placement of physical layer functions: Cat-A and Cat-B. A Cat-A radio unit implements physical layer functions such as OFDM phase compensation, cyclic prefix addition, and digital beamforming in the radio unit, while a Cat-B radio implements precoding function in addition to the physical layer functions implemented in a CAT-A radio. This approach allows optimized implementations of lower-layer splits for various type of radios.

The approach, using E-CPRI to connect the DU and the radio unit, places radio functions such as OFDM phase compensation, cyclic prefix addition, and digital beamforming in the radio unit. The rest of physical layer functions, including resource element mapping, precoding, modulation, scrambling, and coding, are in the DU for the O-RAN CAT-A radio. High-layer protocol functions, such as PDCP, occur in the Centralized Unit (CU), with the connection between Distributed Unit and Centralized Unit referred to as the midhaul interface. Centralized coordination and intelligence at the near-real-time RAN Intelligent Controller can perform functions such as optimization of mobility management, traffic management, network slice management, scheduling policies, and interference management.<sup>152</sup>

## **Edge Computing**

ETSI is standardizing Multi-access Edge Computing, previously known as Mobile-Edge Computing, a technology that empowers a programmable application environment at the edge of the network, within the RAN.<sup>153</sup> Goals include reduced latency, more efficient network operation for certain applications, and an improved user experience. Although MEC emphasizes 5G, especially for applications that need low latency, it can also be applied to 4G LTE networks.

Figure 45 shows how a combination of cloud services, augmented by eventually a far greater number of edge servers, will support billions of devices. Possible participants include existing cloud vendors, cellular operators, computer infrastructure vendors, private enterprises for their own applications, cellular-infrastructure vendors, data center vendors, and new entrants. By collaborating with cellular operators, cloud specialists in particular are now becoming involved in edge computing deployments, including Amazon, Google, and Microsoft.<sup>154</sup>

---

<sup>152</sup> For further details, refer to the O-RAN Alliance white paper, *O-RAN: Towards and Open and Smart RAN*, Oct. 2018.

<sup>153</sup> For further details, see ETSI, "Multi-access Edge Computing," <https://www.etsi.org/technologies/multi-access-edge-computing>. See also, ETSI, *Multi-access Edge Computing (MEC); Framework and Reference Architecture*, ETSI GS MEC 003 V2.1.1 (2019-01). [https://www.etsi.org/deliver/etsi\\_gs/MEC/001\\_099/003/02.01.01\\_60/gs\\_MEC003v020101p.pdf](https://www.etsi.org/deliver/etsi_gs/MEC/001_099/003/02.01.01_60/gs_MEC003v020101p.pdf).

<sup>154</sup> For example, see Fierce Telecom, "Microsoft, AT&T create edge compute zones," Apr. 1. 2020, <https://www.fiercetelecom.com/telecom/microsoft-at-t-create-edge-compute-zones>; Fierce Wireless, "AT&T and Google Cloud forge 5G edge compute partnership for enterprises," Mar. 5, 2020, <https://www.fiercetelecom.com/telecom/at-t-and-google-cloud-forge-5g-edge-compute-partnership-for-enterprises>; Fierce Wireless, "Verizon partners with AWS to bring more power to its 5G edge," Dec.

**Figure 45: Intelligence in the Cloud, the Edge, and in Devices**

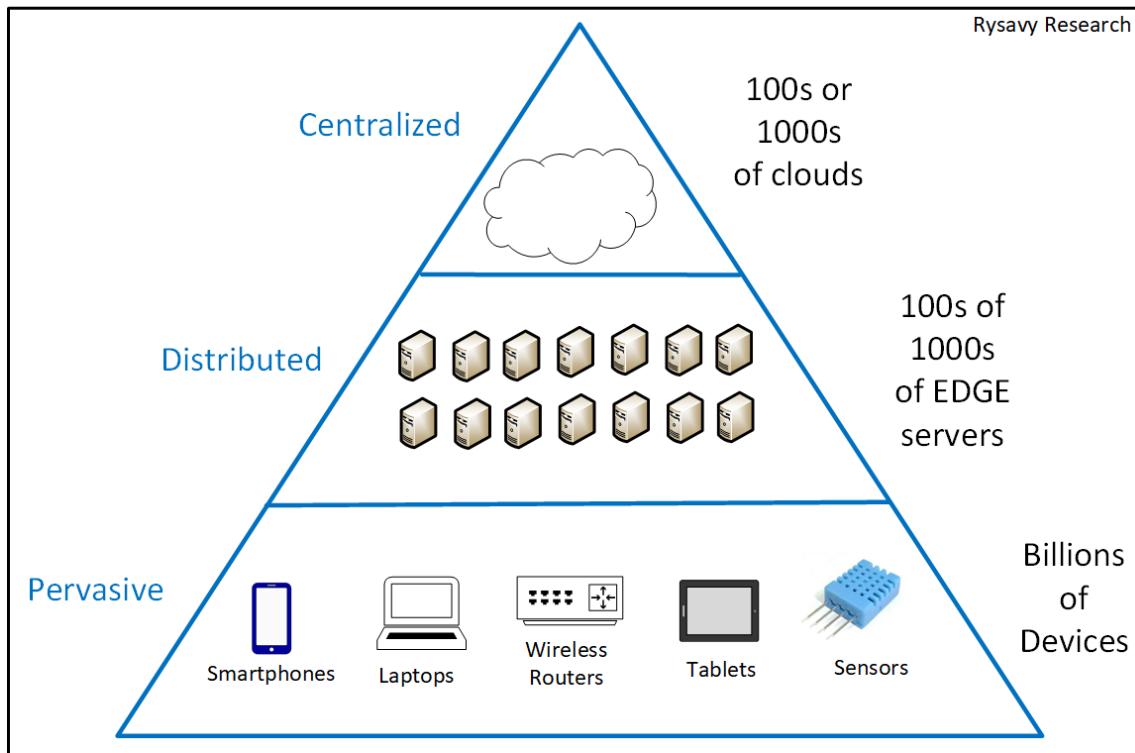

Possible locations for edge servers include:

- ❑ Collocated with virtualized RAN computing locations, such as Centralized Units (as defined in the O-RAN architecture).
- ❑ Macro tower cell sites.
- ❑ Existing and new distributed data centers (for example, operator or cloud vendor).

For many applications, latency will determine how close the edge servers need to be to user devices. 5G networks are striving for 1 msec latency (round-trip time) within the network. Light travels 186 miles (300 km) in 1 msec, so designers will need to plan their applications accordingly. For instance, a cloud-gaming application may tolerate 10 msec of delay and not need to be as close to the device as a robotics controller that can only tolerate a few msec.

The other consideration is the amount of data that needs transportation. An enterprise performing AI-based video analysis of an operation may wish to do such calculations on location rather than backhauling a huge amount of data to a more central location.

Applications that will benefit are ones that require server-side processing but are location specific. Examples include:

---

3, 2019, <https://www.fiercewireless.com/5g/verizon-partners-aws-to-bring-more-power-to-its-5g-edge>.

- ❑ Augmented reality, such as immersive in-store experiences.
- ❑ Virtual reality. Rendition processing can be combined between user device and edge computer.
- ❑ Predictive maintenance that helps detect machines in danger of breaking.
- ❑ Intelligent video processing, such as transcoding, caching, acceleration, and AI-based analysis.
- ❑ Cloud/edge-based game hosting.<sup>155</sup>
- ❑ Connected and autonomous vehicles.
- ❑ IoT applications including industrial automation, such as robotic control.<sup>156</sup>

5G standalone network architecture provides access to user data in a local environment via a distributed User Plane Function (UPF), thus enabling local data breakout and facilitating edge computing.<sup>157</sup> For a detailed discussion of how MEC can operate in a 5G environment, refer to ETSI's white paper, *MEC in 5G Networks*.<sup>158</sup>

3GPP is continuing work to enhance edge computing, including a study item planned for Release 17.<sup>159</sup>

## **Artificial Intelligence (AI)**

Researchers are studying how AI could be used in network infrastructure. 3GPP is incorporating automation and machine learning into its architecture by introducing the Network Data Analytics Function<sup>160</sup> into the 5G-NGC. NWDAF and RAN-DAF will play an important role in network slicing, discussed above in the section "Network Slicing."

Although not standardized yet in any specifications, AI could:

---

<sup>155</sup> See, for example, AT&T, "AT&T Unlocks the Power of Edge Computing: Delivering Interactive VR over 5G," Feb. 21, 2019. [https://about.att.com/innovationblog/2019/02/edge\\_computing\\_vr.html](https://about.att.com/innovationblog/2019/02/edge_computing_vr.html).

<sup>156</sup> See, for example, ZDNet, "MWC 2019: AT&T tests 5G and edge computing with Microsoft Azure," Feb. 26, 2019. <https://www.zdnet.com/article/mwc-2019-at-t-tests-5g-and-edge-computing-with-microsoft-azure/>.

<sup>157</sup> Operators can implement local breakout in LTE networks using a mechanism called Local IP Access (LIPA), but this approach is not as flexible as the UPF function in 5G standalone networks.

<sup>158</sup> ETSI, *MEC in 5G Networks*, ETSI White Paper No. 28, Jun. 2018. [https://www.etsi.org/images/files/ETSIWhitePapers/etsi\\_wp28\\_mec\\_in\\_5G\\_FINAL.pdf](https://www.etsi.org/images/files/ETSIWhitePapers/etsi_wp28_mec_in_5G_FINAL.pdf).

<sup>159</sup> 3GPP, "Study on enhancement of support for Edge Computing in 5G Core network (5GC)," 3GPP Technical Report 23.748. <https://portal.3gpp.org/desktopmodules/Specifications/SpecificationDetails.aspx?specificationId=3622>

<sup>160</sup> 3GPP "Architecture enhancements for 5G System (5GS) to support network data analytics services", TS 23.288. <https://portal.3gpp.org/desktopmodules/Specifications/SpecificationDetails.aspx?specificationId=3579>

- ❑ Optimize the network in real time by controlling connections, such as which base stations users connect with, whether to hand off from cellular to Wi-Fi, mesh configurations for wireless multi-hop backhaul, or load balancing.
- ❑ Improve network self-organizing capabilities.
- ❑ Handle increasing network complexity with an increased number of cell sites (especially small cells), number of devices, and speed of operation.
- ❑ Heal the network to work around failures, such as a base station that becomes inoperable.
- ❑ Employ more efficient scheduling, massive MIMO beam management, congestion control, and radio resource allocation.<sup>161</sup>
- ❑ Organize the radio resources used by different 5G network slices.
- ❑ Reduce tower climbs by using drones with AI interpretation of video images to detect issues.
- ❑ Provide customer-support functions.
- ❑ Augment security functions, such as threat detection.
- ❑ Automate management and orchestration of the network, manage the lifecycle, and monitor the status of a network slice or third-party application performance.

Acumos AI<sup>162</sup> is a platform and open source framework that makes it easy to build, share, and deploy AI apps. Acumos is part of the Linux Foundation's AI Foundation, an umbrella organization within The Linux Foundation that supports and sustains open source innovation in artificial intelligence, machine learning, and deep learning. Acumos standardizes the infrastructure stack and components required to run an out-of-the-box general AI environment. These types of functions are already being standardized, in part, in self-optimizing and self-configuring capabilities, but the addition of AI will increase the sophistication of these capabilities.

ETSI has defined the term "Experiential Networked Intelligence" to refer to an architecture that enables closed-loop network operations and management using AI.<sup>163</sup>

On-device AI will provide numerous benefits:

- ❑ Improved radio signal processing by incorporating location, velocity, massive MIMO channel estimation, and other information about the environment, resulting in improved throughput, better beam management, increased spectral efficiency, and higher reliability.

---

<sup>161</sup> IEEE Spectrum, "Machine Learning Remakes Radio," May 2020; IEEE Wireless Communications, Intelligent Radio: When Artificial Intelligence Meets the Radio Network, Feb 2020.

<sup>162</sup> Acumos AI. <https://www.acumos.org/>

<sup>163</sup> See section 3.3 of ETSI, *Network Transformation; (Orchestration, Network and Service Management Framework)*, Oct. 2019. [https://www.etsi.org/images/files/ETSIWhitePapers/ETSI\\_White\\_Paper\\_Network\\_Transformation\\_2019\\_N32.pdf](https://www.etsi.org/images/files/ETSIWhitePapers/ETSI_White_Paper_Network_Transformation_2019_N32.pdf).



- ❑ Enhanced positioning accuracy through RF sensing, complementing existing positioning methods.
- ❑ Motion and gesture detection by sensing environmental changes to infer type of motion, enabling use cases such as fall detection and vital sign tracking.
- ❑ Improved power management by more efficient application of computing and radio resources based on context.

Users are already using AI on their smartphones with Siri and Google Assistant. AI functions in the future, as shown in Figure 46, will be distributed among centralized clouds, edge clouds, and devices. Centralized clouds will be best for AI training and content not sensitive to delay, whereas edge clouds, with much lower latency, will support real-time interaction and provide information about the environment. Finally, the device can offer the greatest responsiveness, as well as enhanced privacy, by acting on local and personal data.

For vehicle applications, a similar AI architecture will apply, with on-board AI being able to perform:

- ❑ Natural language and gesture understanding.
- ❑ Voice/noise cancellation.
- ❑ Fingerprint recognition and face detection for security.
- ❑ Object classification.
- ❑ Scene understanding.
- ❑ Sensor processing.
- ❑ Context aware safety.

The same three-tier AI architecture for computing and artificial intelligence will also apply to industrial applications and consumer applications such as extended reality.

**Figure 46: Intelligence across Centralized Clouds, Edge Clouds, and Devices**

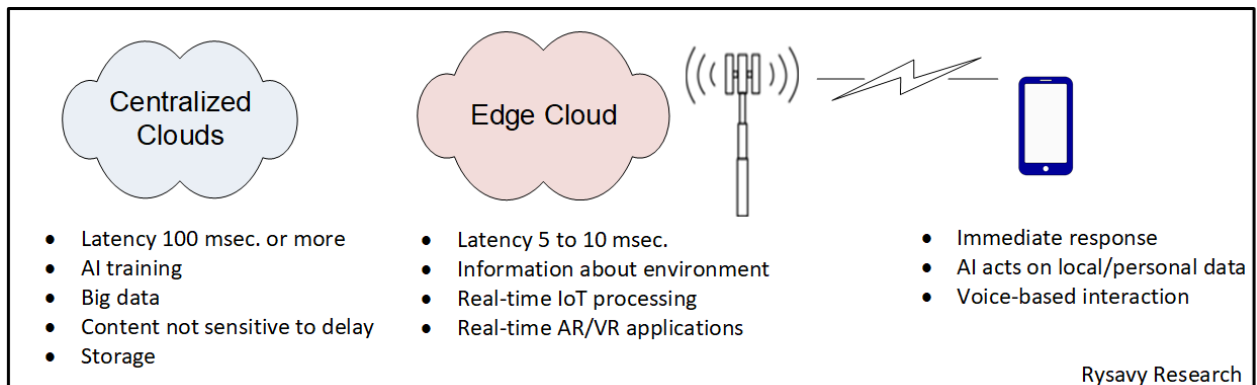
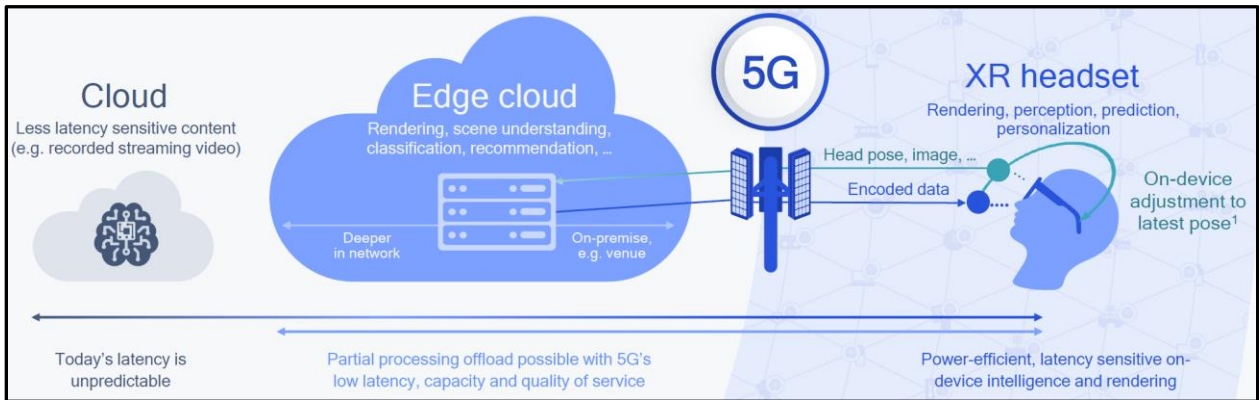

Figure 47 shows how an extended reality headset may perform AI functions locally, such as perception and prediction, but rely on AI in an edge cloud for scene understanding.

**Figure 47: AI Application of Extended Reality<sup>164</sup>**



Similarly, Figure 48 shows how some voice processing can execute on the device to act intuitively and with immediacy while relying on an edge cloud for natural language understanding.

**Figure 48: AI Application of Responsive Voice User Interface<sup>165</sup>**

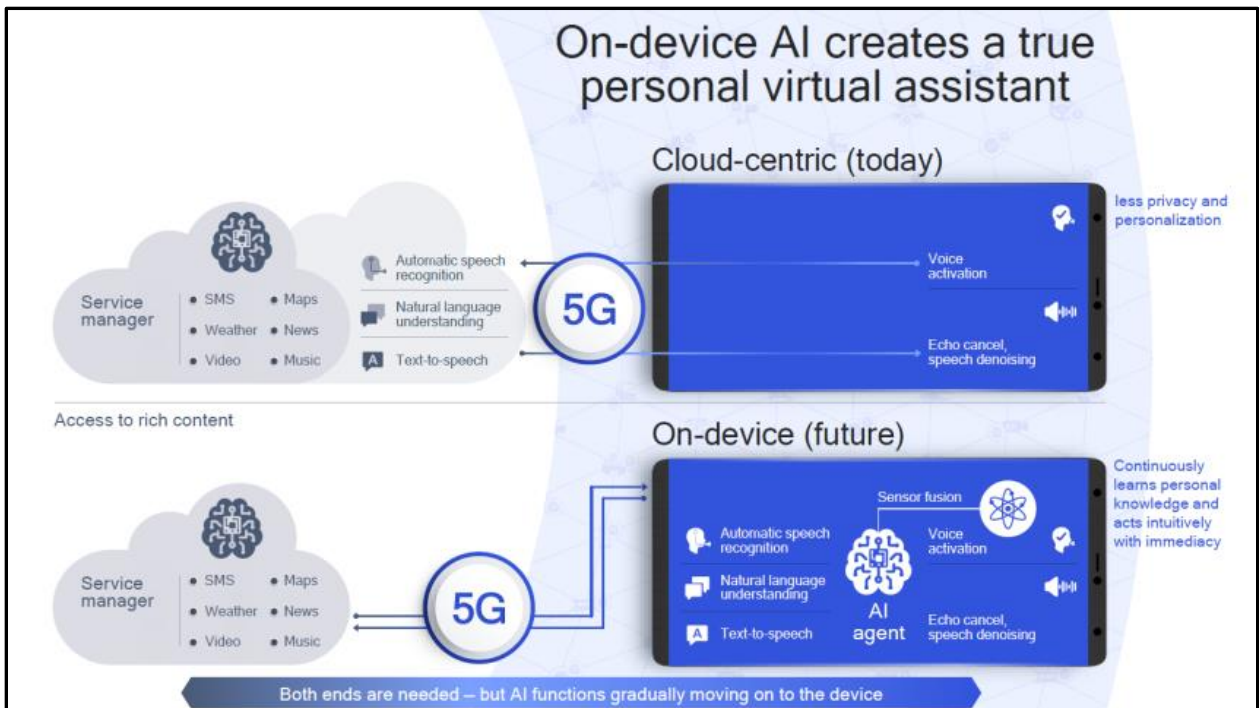

<sup>164</sup> Qualcomm contribution.

<sup>165</sup> Qualcomm contribution.

## ***Unlicensed Spectrum Integration***

Unlicensed spectrum is becoming ever more important to mobile broadband networks. Initial use was rudimentary offload onto Wi-Fi networks, but now, Wi-Fi networks are becoming more tightly integrated into cellular networks.

Unlicensed spectrum adds to capacity in two ways. First, a huge amount of spectrum is available. Amounts vary by country, but the United States has about 100 MHz in 900 MHz and 2.4 GHz bands, 580 MHz at 5G, 80 to 150 MHz in 3.5 GHz CBRS depending on number of licensed channels, and now 1.2 GHz at 6 GHz. Nevertheless, because the spectrum is unlicensed, it must be shared with other potential users, and so the amount of capacity it offers depends on usage by other entities in the environment.

A significant amount of unlicensed spectrum already exists in mmWave bands, with 7 GHz already in use in the United States (57 to 64 GHz) and an additional 7 GHz in 5G spectrum allocations. Second, unlicensed spectrum is mostly used in small coverage areas, resulting in high-frequency re-use.

The IEEE 802.11 family of technologies has experienced rapid growth, mainly in private deployments. The latest 802.11 standard, 802.11ax, emphasizes capacity improvements as well as higher throughputs. In the mmWave frequencies, IEEE has developed 802.11ad, which operates at 60 GHz, and the standards body is currently working on a successor technology, 802.11ay.

Integration between mobile broadband and Wi-Fi networks can be either loose or tight. Loose integration means data traffic routes directly to the internet and minimizes traversal of the operator network. This is called "local breakout." Tight integration means data traffic, or select portions thereof, may traverse the operator core network. An example is Wi-Fi calling, which uses the IP Multimedia Subsystem.

Although offloading onto Wi-Fi can reduce traffic on the core network, the Wi-Fi network does not necessarily always have greater spare capacity than the cellular network. The goal of future integrated cellular/Wi-Fi networks is to intelligently load balance between the two. Simultaneous cellular/Wi-Fi connections will also become possible. For example, in Release 13, 3GPP introduced link aggregation of Wi-Fi and LTE through LWA and LWIP.

Another approach for using unlicensed spectrum employs LTE as the radio technology, initially in a version referred to as LTE-Unlicensed, specified by the LTE-U Forum, which works with Releases 10-12 of LTE. In Release 13, 3GPP specified LAA, which implements listen-before-talk capability, a requirement for unlicensed operation in Europe and Japan. Initially, carrier aggregation combines a licensed carrier with one or more unlicensed channels. Operating LTE in unlicensed bands could decrease the need for handoffs to Wi-Fi. Up to 32 unlicensed carriers (of 20 MHz each) can be aggregated to theoretically access 640 MHz of unlicensed spectrum. LAA has also been specified to operate in the 3.5 GHz CBRS band. Enhanced LAA (eLAA), specified in Release 14, added uplink use of unlicensed spectrum. Carriers are now deploying LAA on a widespread basis.

A concern with using LTE in unlicensed bands was whether it would be a fair neighbor to Wi-Fi users. LTE-U based on Releases 10-12 addressed this concern by selecting clear channels to use and measuring the channel activity of Wi-Fi users, then using an appropriate duty cycle for fair sharing. License-Assisted Access in Release 13 added listen-before-talk (LBT) and implemented other regulatory requirements that exist in some countries. 3GPP conducted a study and concluded that, "A majority of sources providing

evaluation results showed at least one LBT scheme for LAA that does not impact Wi-Fi more than another Wi-Fi network.<sup>166</sup>

MulteFire, specified by the MulteFire Alliance, is an application of LTE in unlicensed bands that does not require an anchor in licensed spectrum, opening up the possibility of deployments by non-operator entities, including internet service providers, venue operators, and enterprises. Under a roaming arrangement with cellular operators, LTE customers could roam into MulteFire networks. Figure 49 shows the evolution of the different versions of LTE for unlicensed bands.

**Figure 49: Timeline Relationship of LTE-U, LAA, eLAA, and MulteFire**

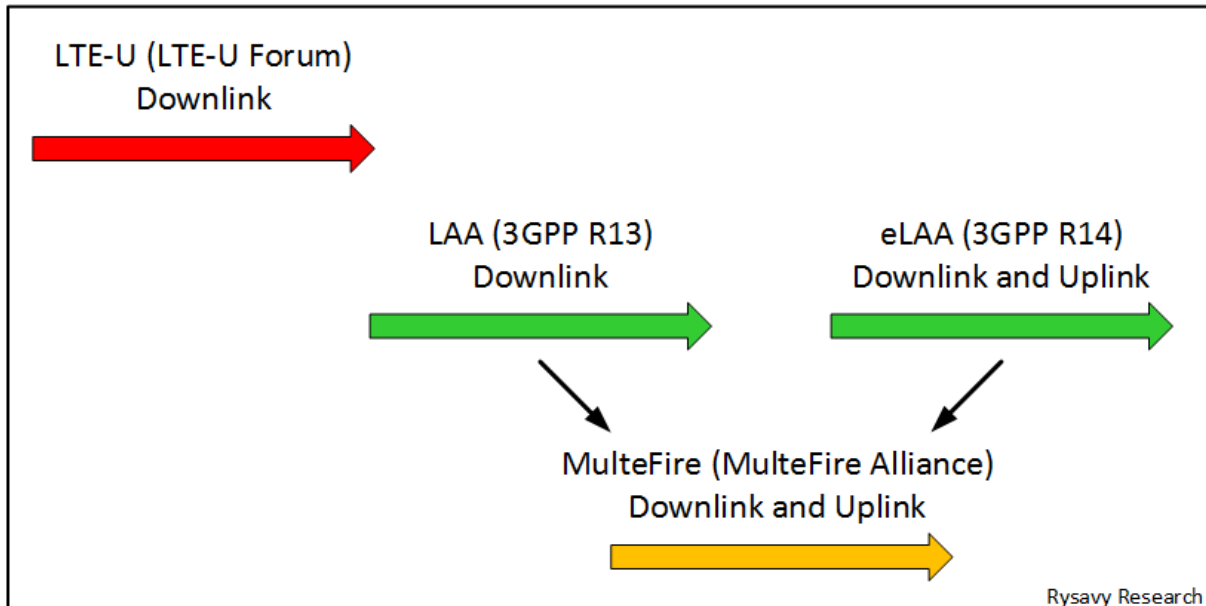

Release 16 specifies support for unlicensed bands in 5G NR for multiple scenarios, providing operators significant flexibility in how they take advantage of unlicensed spectrum:

- ❑ Scenario A: Carrier aggregation between licensed band NR and NR-U. NR-U may have both downlink and uplink, or downlink only.
- ❑ Scenario B: Dual connectivity between licensed band LTE and NR-U.
- ❑ Scenario C: Standalone NR-U.
- ❑ Scenario D: An NR cell with DL in unlicensed band and UL in licensed band.
- ❑ Scenario E: Dual connectivity between licensed band NR and NR-U.

The 3GPP study concluded that NR-U and Wi-Fi will be able to coexist in adjacent channels and that if, "NR-U has similar leakage and selectivity requirements as LAA, the LAA study

---

<sup>166</sup> 3GPP, Technical Specification Group Radio Access Network; *Study on Licensed-Assisted Access to Unlicensed Spectrum*; (Release 13). 36.889. See section 9, "Conclusions."

can be used to conclude that NR-U will cause less adjacent channel interference to a Wi-Fi system compared to another Wi-Fi system.”<sup>167</sup>

While LTE LAA works with the 5 GHz unlicensed band, NR-U is being designed to work with both the 5 GHz and 6 GHz unlicensed bands, and in unlicensed mmWave bands in the future (possibly Release 18).

With LTE, the MulteFire Alliance specified operation of LTE in unlicensed bands without an anchor in licensed bands, but with 5G, 3GPP is standardizing such operation. The standalone operation will open new use cases, such as private networks for industrial IoT, mobile broadband for enterprises, and mobile broadband services offered by entities other than cellular operators.

An alternative approach for integrating Wi-Fi with LTE is LWA. LTE handles the control plane, but connections occur over separate LTE base stations and Wi-Fi access points. LWA benefits operators that wish to emphasize Wi-Fi technology for harnessing capacity in unlicensed spectrum. LWIP is a variation of LWA that also integrates LTE and Wi-Fi, but by integrating at a higher level of the protocol stack (IP instead of PDCP), it facilitates use of existing Wi-Fi equipment and devices, with integration typically occurring at the eNodeB.

Figure 50 shows how the different technologies exploit licensed and unlicensed spectrum.

---

<sup>167</sup> Ibid.

**Figure 50: How Different Technologies Harness Spectrum**

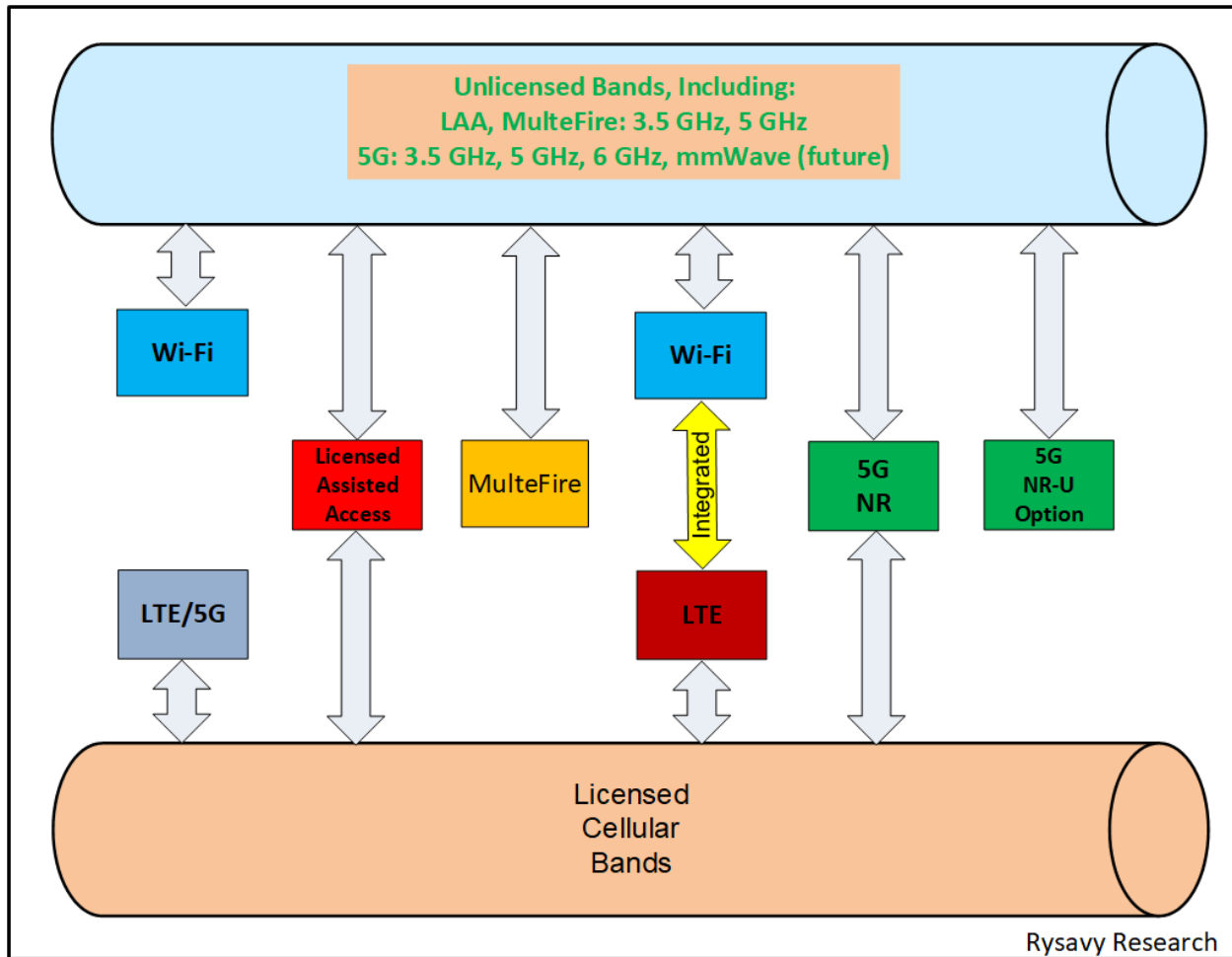

Table 11 summarizes the different uses of unlicensed spectrum for public mobile broadband networks.

**Table 11: Approaches for Using Unlicensed Spectrum.**

	Technology	Attributes
<b>Wi-Fi</b>	Ever-more-sophisticated means to integrate Wi-Fi in successive 3GPP Releases.	Combining Wi-Fi with cellular increases capacity.
<b>Release 13 RAN Controlled LTE WLAN Interworking</b>	Base station can instruct the UE to connect to a WLAN for offload.	Available in late 2017 or 2018 timeframe.
<b>Release 10-12 LTE-U Based on LTE-U Forum Specifications</b>	LTE-U Forum-specified approach for operating LTE in unlicensed spectrum.	Available in 2017. More seamless than Wi-Fi. Cannot be used in some regions (e.g., Europe, Japan).

	Technology	Attributes
<b>Release 13 Licensed-Assisted Access</b>	3GPP-specified approach for operating LTE in unlicensed spectrum. Downlink only.	Available in 2018. Designed to address global regulatory requirements.
<b>Release 14 Enhanced Licensed-Assisted Access</b>	Addition of uplink operation.	Available in 2019.
<b>NR-U</b>	Specified in Release 16.	Available in 2021-2022 timeframe.
<b>MulteFire</b>	Does not require a licensed anchor.	Potentially creates a neutral-host small cell solution.
<b>LWA</b>	Aggregation of LTE and Wi-Fi connections at PDCP layer.	Part of Release 13.
<b>LWIP</b>	Aggregation of LTE and Wi-Fi connections at IP layer.	Part of Release 13.

Cellular operators are currently emphasizing simple offload to Wi-Fi or LTE-U/LAA. Aggregation techniques, such as LWA and LWIP, do not currently have market traction.

Refer to the appendix sections “NR-U in Detail” and “Other Unlicensed Spectrum Integration” for further technical details.

## Multiple Cell Types

Operators have many choices for providing coverage. Lower frequencies propagate further and thus require fewer cells for coverage. The resulting network, however, has lower capacity than one with more cells, so operators must continually evaluate cell placement with respect to both coverage and capacity.

Table 12 lists the many types of cells. Note that the distinctions, such as radius, are not absolute—perhaps one reason the term “small cell” has become popular, as it encompasses picocells, metrocells, femtocells, and sometimes Wi-Fi.

With “plug-and-play” capability derived from self-configuring and self-organizing features, small cells will increasingly be deployed in an ad hoc manner, anywhere power and backhaul are available, yet will operate in tight coordination with the rest of the network.

A proliferation of small cells inside buildings will also provide coverage from inside to outside, such as in city streets, the reverse of traditional coverage that extends from outdoor cells to inside.

**Table 12: Types of Cells and Typical Characteristics (Not Formally Defined)**

Type of Cell	Characteristics
Macro cell	Wide-area coverage. LTE supports cells up to 100 km in range, but typical distances are 0.5-5 km radius. Always installed outdoors.
Microcell	Covers a smaller area, such as a hotel or mall. Range to 2 km, 5-10W, and 256-512 users. Usually installed outdoors.

Type of Cell	Characteristics
Picocell	Indoor or outdoor. Outdoor cells, also called "metrocells." Typical range of up to 200 meters outdoors and 10-25 meters indoors, 1-2W, 64-128 users. Deployed by operators primarily to expand capacity.
Consumer Femtocell	Indoors. Range to 10 meters, less than 50 mW, and 4-6 users. Capacity and coverage benefit. Usually deployed by end users using their own backhaul.
Enterprise Femtocell	Indoors. Range to 25 meters, 100-250 mW, 16-32 users. Capacity and coverage benefit. Deployed by operators.
Distributed antenna system	Expands indoor or outdoor coverage. Same hardware can support multiple operators (neutral host) since antenna can support broad frequency range and multiple technologies. Indoor deployments are typically in larger spaces such as airports. Has also been deployed outdoors for coverage and capacity expansion.
Remote radio head (RRH)	Uses baseband at existing macro site or centralized baseband equipment. If centralized, the system is called "cloud RAN." Requires fiber connection.
Wi-Fi	Primarily provides capacity expansion. Neutral-host capability allows multiple operators to share infrastructure.

Historically, increasing the number of cell sites has been the primary method for increasing capacity, providing gains far greater than what can be achieved by improvements in spectral efficiency alone.

Central to small-cell support is the heterogeneous network architecture, with multiple types of cells serving a coverage area, varying in frequencies used, radius, and even radio technology used.

HetNets offer significant increases in capacity and improvements, including:

1. Smaller cells, such as open femtocells (home-area coverage) and picocells (city-block-area coverage), inherently increase capacity because each cell serves a smaller number of users.
2. Strategic placement of picocells within the macro cell provides the means to absorb traffic in areas where there are higher concentrations of users. Locations can include businesses, airports, stadiums, convention centers, hotels, hospitals, shopping malls, high-rise residential complexes, and college campuses.
3. Smaller cells can also improve signal quality in areas where the signal from the macro cell is weak.

Essential elements for practical HetNet deployment are self-optimization and self-configuration, especially as the industry transitions from tens of thousands of cells to hundreds of thousands, and eventually to millions. The appendix covers technical aspects of HetNets in the sections "Heterogeneous Networks and Small Cells" and "Self-Organizing Networks."

While promising in the long term, one immediate challenge in deploying a large number of small cells is backhaul, since access to fiber is not necessarily available and line-of-sight



microwave links are not always feasible. The planned integrated access and backhaul capability of 5G, however, will help address this problem. Site acquisition and the need for multiple operators to deploy their own cells in a coverage area are additional challenges.<sup>168</sup> Figure 51 depicts the challenges.

**Figure 51: Small-Cell Challenges**

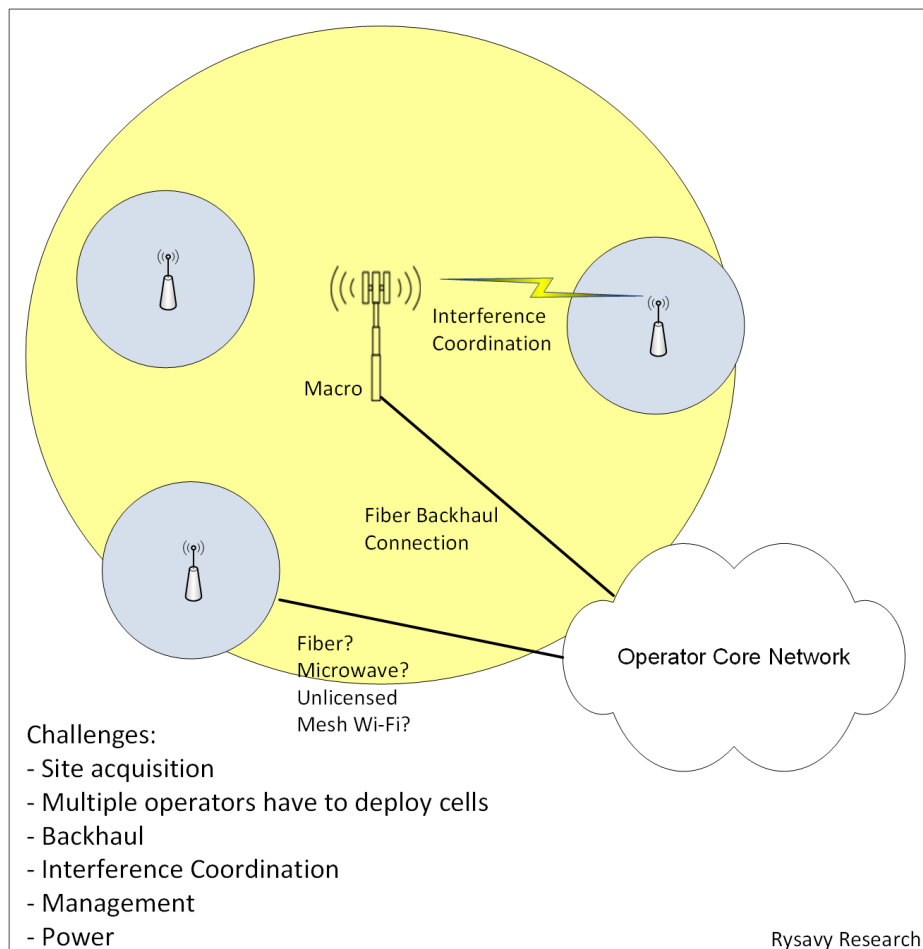

Despite these challenges and the relatively modest number of small cells deployed today, small-cell deployments are accelerating. Rysavy Research projects one million small cells will be deployed in the United States by 2027.<sup>169</sup>

In March of 2018, the FCC issued rules that streamline the environmental and historical review process for siting. The FCC then issued a report and order in September 2018, titled “Accelerating Wireline Broadband Deployment by Removing Barriers to

<sup>168</sup> For further discussion of this topic, refer to 5G Americas and Small Cell Forum, *Small cell siting challenges*, Feb. 2017.

<sup>169</sup> Rysavy Research and Datacomm Research, *Broadband Disruption: How 5G Will Reshape the Competitive Landscape*, 2018. <https://datacommresearch.com/reports-broadband/>.

Infrastructure Investment,” that addressed shot clocks (processing time) for site applications and fee structures.

5G small-cell considerations include:

- ❑ Due to limited propagation at mmWave frequencies, 5G small-cell deployments will be dense and involve large numbers of sites. Inter-site distances (ISDs) will range from 100 to 300 meters in many deployments, with 200 meters a typical value.<sup>170</sup>
- ❑ The high capacity of mmWave small cells will require multi-Gbps backhaul connections using an expected combination of fiber, mmWave radio in point-to-point connections, and 5G self-backhaul.
- ❑ The expected use of cloud RAN and centralized base station facilities will simplify equipment at the site, facilitating dense deployments.
- ❑ Dense deployments will motivate neutral-host (multi-tenant) approaches, but these are outside the scope of specification efforts.
- ❑ The integrated access and backhaul capability being specified for Release 16 will reduce the number of sites needing fiber. (See “5G Architecture” above and “Integrated Access and Backhaul” in the appendix.)
- ❑ Operators could partner with cable operators to leverage existing hybrid fiber-coaxial networks for backhaul and power.

The effective range of a mmWave small cell depends on multiple factors, including whether line-of-sight is available, extent of foliage, pole height, whether user equipment is indoors or outdoors, and the types of building materials the signal must pass through to reach indoor equipment.

Despite the challenges, small cells will ultimately contribute greatly to increased network capacity. Table 13 lists possible configurations; note that many of these approaches can be combined, such as using picocells and Wi-Fi offload.

**Table 13: Small-Cell Approaches**

Small-Cell Approach	Characteristics
Macro plus small cells in select areas.	Significant standards support. Femtocells or picocells can use the same radio carriers as macro (less total spectrum needed) or different radio carriers (greater total capacity).
Macro in licensed band plus LTE/5G operation in unlicensed bands.	Promising approach for augmenting LTE capacity in scenarios where an operator is deploying LTE or 5G small cells. <sup>171</sup> See discussion below in the section on unlicensed spectrum integration.
Macro (or small cell) cellular in licensed band plus Wi-Fi.	Extensively used today with increased use anticipated. Particularly attractive for expanding capacity in coverage areas where Wi-Fi infrastructure exists but small cells with LTE do not.

<sup>170</sup> 5G Americas member contributions.

<sup>171</sup> See Rysavy Research, *Accelerating Innovation in Unlicensed Spectrum*, Fierce Wireless, Nov. 2016. <https://rysavyresearch.files.wordpress.com/2017/08/2016-11-innovation-unlicensed-spectrum.pdf>.

Small-Cell Approach	Characteristics
	LTE Wi-Fi Aggregation (being specified in Release 13) is another approach, as are MP-TCP and MP-QUIC.
Wi-Fi only.	Low-cost approach for high-capacity mobile broadband coverage, but impossible to provide large-area continuous coverage without cellular component.

## **Neutral-Host Small Cells**

Multi-operator and neutral-host solutions could accelerate deployment of small cells.<sup>172</sup> Currently, nearly all small-cell deployments are operator-specific, but in the future, deployments supporting multiple operators could reduce the cost per operator to provide coverage.

A candidate band for neutral-host small cells is 3.5 GHz, using LTE TDD and MulteFire as potential technologies. Wi-Fi technology also addresses neutral-host configurations at the access level, but it has roaming and authentication challenges. HotSpot 2.0 (covered in the appendix) addresses roaming and authentication.

## **Massive MIMO**

Smart antennas, defined with progressively greater capabilities in successive 3GPP releases, provide significant gains in throughput and capacity. By employing multiple antennas at the base station and the subscriber unit, the technology either exploits signals traveling through multiple paths in the environment or does beam steering, in which multiple antennas coordinate their transmissions to focus radio energy in a particular direction.

### **LTE**

Initial low-band LTE deployments used 2X2 MIMO on the downlink (two base station transmit antennas, two mobiles receive antennas) and 1X2 on the uplink (one mobile transmit antenna, two base station receive antennas). In the higher bands, 2X2 downlink MIMO has been deployed, but it is more common to employ four antennas for uplink reception in a 1X4 configuration. LTE deployments are now using 4X2 MIMO and 4X4 MIMO on the downlink (four base station transmit antennas). LTE specifications encompass higher-order configurations, such as 4X4 MIMO, 8X2 MIMO, and Multi-User MIMO (MU-MIMO) on the downlink and 1X4 on the uplink. Practical considerations, such as antenna sizes that are proportional to wavelength, dictate MIMO options for different bands.

Operators are now also deploying massive MIMO systems, which employ a far larger number of antenna elements at the base station—64, 128, and eventually even more. 3GPP has developed specifications for massive MIMO for 4G systems in what it calls full-dimension MIMO (FD-MIMO). Release 14 specifies configurations with up to thirty-two antennas at the base station.

---

<sup>172</sup> 5G Americas and Small Cell Forum, *Multi-operator and neutral host small cells; Drivers, architectures, planning and regulation*, Dec. 2016. <https://www.5gamericas.org/multi-operator-and-neutral-host-small-cells-drivers-architectures-planning-and-regulation/>.

Massive MIMO is practical even in cellular frequencies. For example, at 2.5 GHz, an 8X8 array using half wavelength spacing would produce a form factor of 50 cm X 50 cm. Sprint, for example, is deploying sixty-four Transmit and sixty-four Receive radios at 2.5 GHz.<sup>173</sup>

Applications of such arrays include beamforming along a horizontal direction as well as beamforming in a vertical direction, such as to serve different levels of high-rise buildings.

See the appendix sections “LTE Smart Antennas” and “LTE-Advanced Antenna Technologies” for further details about use of Massive MIMO in LTE.

## **5G**

Advanced antenna systems are essential for realizing the potential of 5G NR. For bands below 6 GHz, massive MIMO focuses on capacity enhancement, whereas for higher bands such as mmWave, massive MIMO focuses on coverage enhancement. Massive MIMO enables beamforming, improving propagation, and in combination with MU-MIMO, also improves capacity.<sup>174</sup>

For 5G initial deployments, base stations typically use 128 to 256 antenna elements below 6 GHz and 256 to 512, or more, antenna elements at mmWave frequencies. Mobile devices have between four and thirty-two elements. This configuration supports three-dimensional beamforming.<sup>175</sup>

Typical configurations for active antennas in mid-band frequencies are 16T16R, 32T32R, and 64T64R. A 64T64R configuration allows up to sixteen layers of communications.

For a detailed discussion, refer to the 2019 5G Americas white paper, *Advanced Antennas Systems for 5G*.<sup>176</sup>

## **Multicast and Broadcast**

Another important new service is video streaming via multicast or broadcast functions. 3GPP has defined multicast/broadcast capabilities for both HSPA and LTE. Mobile TV services have experienced little business success so far, but broadcasting uses the radio resource much more efficiently than having separate point-to-point streams for each user. For example, users at a sporting event might enjoy watching replays on their smartphones. The technology supports these applications; it is a matter of operators and content providers finding appealing applications.

3GPP Release 14 provides mixed-mode broadcast that employs dynamic switching between unicast and broadcast, allowing efficient network delivery of identical content to multiple subscribers.

---

<sup>173</sup> See, for example, Sprint, “Sprint Unveils Six 5G-Ready Cities; Significant Milestone Toward Launching First 5G Mobile Network in the U.S.,” Feb. 27, 2018, available <http://newsroom.sprint.com/sprint-unveils-5g-ready-massive-mimo-markets.htm>.

<sup>174</sup> Ericsson, “Advanced antenna systems for 5G networks.” <https://www.ericsson.com/en/reports-and-papers/white-papers/advanced-antenna-systems-for-5g-networks>.

<sup>175</sup> Qualcomm webinar, “Breaking the wireless barriers to mobilize 5G NR mmWave,” Jan. 2019.

<sup>176</sup> [https://www.5gamericas.org/wp-content/uploads/2019/08/5G-Americas\\_Advanced-Antenna-Systems-for-5G-White-Paper.pdf](https://www.5gamericas.org/wp-content/uploads/2019/08/5G-Americas_Advanced-Antenna-Systems-for-5G-White-Paper.pdf).

The appendix covers technical aspects in more detail.

## ***Information-Centric Networking***

For many usage scenarios, wireless networks provide broadband access to the internet, a network that itself is evolving. The internet is based on a node-centric design developed forty years ago. The internet's point-to-point method of communication has functioned well for a vast array of applications but is not optimal for the way content is developed and distributed today. Industry and academic organizations are researching a concept called "Information-Centric Networking." ICN seeks a new approach of in-network caching that distributes content on a large scale, cost-efficiently and securely.

Most internet content uses Uniform Resource Identifiers (URIs) to locate objects and define specific location-dependent IP addresses. This approach, however, causes problems when content moves, sites change domains, or content is replicated, and each copy appears as a different object. Developments such as peer-to-peer overlays and content distribution networks (such as Akamai) that distribute cached copies of content are a first step toward an information-centric communication model.

ICN is built from the ground up on the assumption of mobility, so it eliminates the mobility overlays on which current mobile broadband networks depend. The approach will be able to place information anywhere in the network with immediate and easy retrieval.

Key principles of ICN include:

- ❑ The architecture inherently supports user mobility.
- ❑ Network operations are name-based instead of address- or node-based.
- ❑ The network itself stores, processes, and forwards information.
- ❑ Intrinsic security guarantees the integrity of every data object.

The goal of ICN is to simplify the storage and distribution of gigantic amounts of content while reducing the amount of traffic and latency users face when accessing the content. The internet cannot just be replaced, however, so in initial stages, ICN would operate as an overlay, and over time, assume an increasing percentage of the functions within the internet. ICN would not discard IP; rather, it seeks to generalize the routing concept to enrich networking with new capabilities.

Some technology aspects of ICN include:

- ❑ Information retrieval from multiple sources without needing to know the location of the information.
- ❑ Multipath communications that improves user performance and traffic load balancing.
- ❑ Subsequent requests for the same data will be served locally without needing to fetch it from original repository.
- ❑ Elimination of the name-to-location indirection associated with Domain Name Service (DNS).

Because mobility is such a central aspect of ICN, mobile network operators are in a unique position to participate in ICN-related research and development, and to do so as part of

5G development. ICN has not progressed to a level at which 3GPP specification work could include it, so instead promoters are ensuring that 5G specification work does not preclude it. With this approach, operators in the 2020s will have the option of overlaying ICN capability on their 5G networks. ICN could even be implemented as a 5G network slice for mobile and end-systems capable of ICN.

## 4G LTE Advances

As competitive pressures in the mobile broadband market intensified and demand for capacity persistently grew, LTE became the favored 4G solution because of its high data throughputs, low-latency, and high spectral efficiency. Specifically:

- ❑ **Wider Radio Channels.** LTE can be deployed in wide radio channels (for example, 10 MHz or 20 MHz) with carrier aggregation now up to 640 MHz.
- ❑ **Easiest MIMO Deployment.** By using new radios and antennas, LTE facilitates MIMO Deployment, in contrast to the logistical challenges of adding antennas for MIMO to existing legacy technologies. Furthermore, MIMO gains are maximized because all user equipment supports it from the beginning.
- ❑ **Best Latency Performance.** For some applications, low latency (packet traversal delay) is as important as high throughput. With a low transmission time interval (TTI) of one millisecond (msec) and a flat architecture (fewer nodes in the core network), LTE has the lowest latency of any cellular technology.

LTE is available in both Frequency Division Duplex (FDD) and Time Division Duplex (TDD) modes. Many deployments are based on FDD in paired spectrum. The TDD mode, however, is important for deployments in which paired spectrum is unavailable. Instances of TDD deployment include China, Europe at 2.6 GHz, the United States at 2.5 GHz, and the 3.5 GHz band.

LTE was first specified in 3GPP Release 8. Enhancements in the 2013 to 2016 period were defined in 3GPP Releases 10, 11, and 12, and are commonly referred to as LTE-Advanced.<sup>177</sup> Subsequent releases, including Releases 13-15, specify LTE-Advanced Pro.

### ***LTE-Advanced and LTE-Advanced Pro Features***

Keeping in mind that different operators have varying priorities, the following list roughly ranks the most important features of LTE-Advanced and LTE-Advanced Pro for the 2020 to 2022 timeframe:

- ❑ **Carrier Aggregation.** With this capability already in use, operators can aggregate radio carriers in the same band or across disparate bands to improve throughputs (under light network load), capacity, and efficiency. Carrier aggregation can also combine FDD and TDD and is the basis of LTE-U and LTE-LAA. As examples, in 2015, AT&T aggregated 700 MHz with AWS and with PCS. T-Mobile aggregated

---

<sup>177</sup> From a strict standards-development point of view, the term “LTE-Advanced” refers to the following features: carrier aggregation, 8X8 downlink MIMO, and 4XN uplink MIMO with N the number of receive antennas in the base station.

700 MHz with AWS and AWS with PCS.<sup>178</sup> Operators are now deploying three-carrier aggregation and eventually will aggregate four carriers.<sup>179</sup> Release 13 introduced support for carrier aggregation of up to thirty-two carriers, addressing primarily the opportunity to aggregate multiple unlicensed channels. Release 14 specifies interband carrier aggregation for up to five downlink carriers and two uplink carriers.

- ❑ **VoLTE.** Initially launched in 2015 and with widespread availability by 2017, VoLTE enables operators to roll out packetized voice for LTE networks, resulting in greater voice capacity and higher voice quality.
- ❑ **Tighter Integration of LTE with Unlicensed Bands.** LTE-U became available for testing in 2016, and 3GPP completed specifications for LAA in Release 13, with deployment beginning in 2018. MulteFire, a non-3GPP technology based on LTE, operates without requiring a licensed carrier anchor. LTE/Wi-Fi Aggregation (LWA) and LTE WLAN Radio Level Integration with IPsec Tunnel (LWIP) are other options for operators with large Wi-Fi deployments.
- ❑ **Enhanced Support for IoT.** Release 13 brought Category M1, a low-cost device option, along with Narrowband-IoT (NB-IoT), a version of the LTE radio interface specifically for IoT devices, called Category NB1.
- ❑ **Higher-Order and Full-Dimension MIMO.** Deployments in 2017 began to use up to 4X4 MIMO, which was deployed throughout many networks by 2019. Release 14 specifies a capability called Full-Dimension MIMO, which supports configurations with as many as thirty-two antennas at the base station. See the section “Smart Antennas and MIMO” and appendix section “LTE Smart Antennas” for further detail.
- ❑ **Massive MIMO.** Operators are selectively deploying MIMO antenna configurations with up to 128 antenna elements.<sup>180</sup>
- ❑ **Virtualization.** Although not part of 3GPP specifications, some operators have deployed network-function virtualization and software-defined networking approaches to reduce costs and facilitate deployment of new services.
- ❑ **High-Accuracy Positioning Enhancement.** Release 15 provided means for high-accuracy location data with sub-meter accuracy, even approaching one-centimeter accuracy. The method uses Global Navigation Satellite System (GNSS) stations placed in known locations, forming a network of reference stations that provide correction data to assist in accurate estimation of location. The resulting accuracy supports use cases within industry and agriculture.

---

<sup>178</sup> AT&T band combinations are 3GPP Band 13 + Band 4, Band 17 + Band 4, and Band 17 + Band 2. T-Mobile band combinations are Band 12 + Band 4, Band 12 + Band 2, and Band 4 + Band 2.

<sup>179</sup> For carrier aggregation to operate, both the network and the device have to support the particular band combination. Legacy devices typically do not support new network aggregation capabilities.

<sup>180</sup> See for example, Sprint, “Sprint Unveils Six 5G-Ready Cities; Significant Milestone Toward Launching First 5G Mobile Network in the U.S.,” Feb. 27, 2018, available <http://newsroom.sprint.com/sprint-unveils-5g-ready-massive-mimo-markets.htm>. Viewed May 14, 2018.

- ❑ **Dual Connectivity.** Release 12 introduced the capability to combine carriers from different sectors and/or base stations (i.e. evolved Node Bs [eNBs]) through a feature called Dual Connectivity. Two architectures were defined: one that supports Packet Data Convergence Protocol (PDCP) aggregation between the different eNBs and one that supports separate S1 connections on the user-plane from the different eNBs to the Evolved Packet Core (EPC).
- ❑ **256 QAM Downlink and 64 QAM Uplink.** Defined in Release 12 and already deployed in some networks, higher-order modulation increases user throughput rates in favorable radio conditions.
- ❑ **1 Gbps Capability.** Using a combination of 256 QAM modulation, 4X4 MIMO, and aggregation of three carriers (including two unlicensed carriers via LAA), operator networks can now reach 1 Gbps peak speeds. See below for more information.
- ❑ **V2X Communications.** Release 14 specifies vehicle-to-vehicle and vehicle-to-infrastructure communications. See the section “Cellular V2X Communications” for more information.
- ❑ **Coordinated Multi Point.** CoMP (and enhanced CoMP [eCoMP]) is a process by which multiple base stations or cell sectors process a User Equipment (UE) signal simultaneously, or coordinate the transmissions to a UE, improving cell-edge performance and network efficiency. Initial usage will be on the uplink because no user device changes are required. Some networks had implemented this feature in 2017.
- ❑ **HetNet Support.** HetNets integrate macro cells and small cells. A key feature is enhanced inter-cell interference coordination (eICIC), which improves the ability of a macro and a small cell to use the same spectrum. This approach is valuable when the operator cannot dedicate spectrum to small cells.
- ❑ **Ultra-Reliable and Low-Latency Communications.** Being specified in Release 15, URLLC in LTE shortened radio latency to a one msec range using a combination of shorter transmission time intervals and faster hybrid automatic repeat request (HARQ) error processing. See the appendix section “LTE Ultra-Reliable and Low-Latency Communications” for further details.
- ❑ **Self-Organizing Networks.** With SON, networks can automatically configure and optimize themselves, a capability that will be particularly important as small cells begin to proliferate. Vendor-specific methods are common for 3G networks, and trials are now occurring for 4G LTE standards-based approaches.
- ❑ **Control User Plane Separation (CUPS).** Separating control and user planes allows operators to scale both plane types independently and more cost-effectively.<sup>181</sup>

Other key features include enhanced Multimedia Broadcast/Multicast Services (eMBMS), User-Plane Congestion Management (UPCON), and device-to-device communication (targeted initially at public-safety applications).

---

<sup>181</sup> Cisco, “Control Plane and User Plane Separation (CUPS) Data Sheet,” Oct. 25, 2018. <https://www.cisco.com/c/en/us/solutions/collateral/service-provider/ultra-services-platform/data-sheet-c78-741416.html>.



The appendix explains these features and quantifies performance gains, and Figure 52 illustrates the transition from LTE to LTE-Advanced and LTE-Advanced Pro, which includes these features.

**Figure 52: LTE to LTE-Advanced Pro Migration<sup>182</sup>**

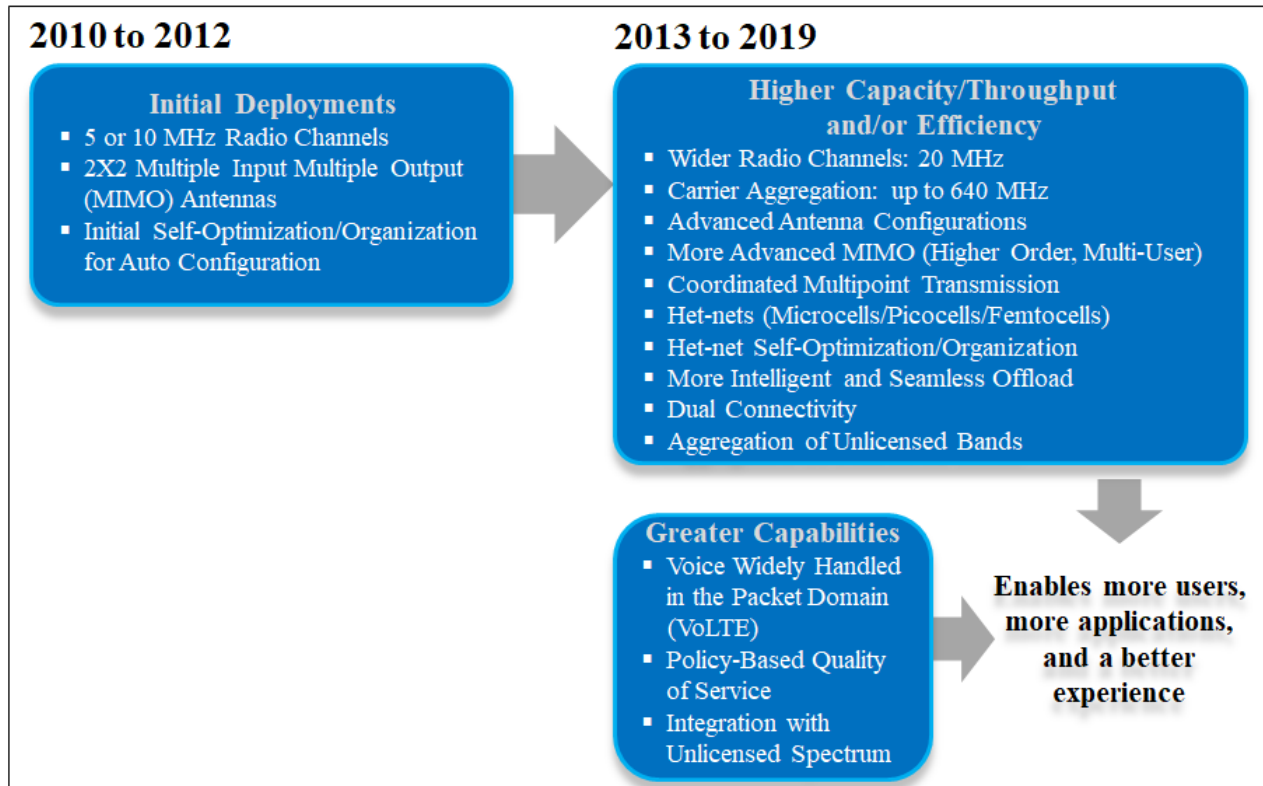

### ***LTE 1 Gbps Capability***

A significant enhancement to LTE has been its recent ability to achieve greater than 1 Gbps peak speeds, providing multiple benefits:

- ❑ A better user experience.
- ❑ Expansion of capacity because Gbps capability often employs unlicensed spectrum.
- ❑ A more consistent user experience between 4G and 5G.

Table 14 shows the methods for operators to achieve 1 Gbps capability, including MIMO, 256 QAM, and carrier aggregation.

<sup>182</sup> 5G Americas/Rysavy Research

**Table 14: Elements of 1 Gbps Downlink Capability**

Capability	Gain	Resulting Peak Throughput (Mbps)
LTE in 20 MHz with 64 QAM	Baseline	75
2X2 MIMO	100%	150
256 QAM	25%	200
4X4 MIMO	100%	400
3 Component Carrier Aggregation (For example, 10 MHz licensed carrier + 2 of 20 MHz unlicensed carriers)	250%	1000
Additional Carrier Aggregation	Additional gains	> 1000

LAA facilitates accessing additional bands in unlicensed spectrum, such as combining two unlicensed 20 MHz channels with one licensed 10 MHz downlink channel, an amount of licensed spectrum available to most operators.

## 3GPP Releases

3GPP standards development falls into three principal areas: radio interfaces, core networks, and services. Progress in the 3GPP family of technologies has occurred in multiple phases, first with GSM, then GPRS, EDGE, UMTS, HSPA, HSPA+, LTE, LTE-Advanced, LTE-Advanced Pro, and now 5G. Underlying radio approaches have evolved from Time Division Multiple Access (TDMA) to CDMA to Orthogonal Frequency Division Multiple Access (OFDMA), which is the basis of LTE and 5G. 3GPP is also evaluating approaches such as non-orthogonal multiple access (NOMA) for 5G.

Table 15 summarizes the key 3GPP technologies and their characteristics.

**Table 15: Characteristics of 3GPP Technologies**

Technology Name	Type	Characteristics	Typical Downlink Speed	Typical Uplink Speed
HSPA <sup>183</sup>	WCDMA	Data service for UMTS networks. An enhancement to original UMTS data service.	1 Mbps to 4 Mbps	500 Kbps to 2 Mbps

<sup>183</sup> HSPA and HSPA+ throughput rates are for a 5+5 MHz deployment.

Technology Name	Type	Characteristics	Typical Downlink Speed	Typical Uplink Speed
HSPA+	WCDMA	Evolution of HSPA in various stages to increase throughput and capacity and to lower latency.	1.9 Mbps to 8.8 Mbps in 5+5 MHz <sup>184</sup> 3.8 Mbps to 17.6 Mbps with dual carrier in 10+5 MHz	1 Mbps to 4 Mbps in 5+5 MHz or in 10+5 MHz
LTE	OFDMA	New radio interface that can use wide radio channels and deliver extremely high throughput rates. All communications handled in IP domain.	6.5 to 26.3 Mbps in 10+10 MHz <sup>185</sup>	6.0 to 13.0 Mbps in 10+10 MHz
LTE-Advanced	OFDMA	Advanced version of LTE designed to meet IMT-Advanced requirements.	Significant gains through carrier aggregation, 4X2 and 4X4 MIMO, and 256 QAM modulation.	
5G	OFDMA	Scalable radio interface designed for 5G able to support existing cellular bands as well as mmWave bands.	1 Gbps with 400 MHz radio channel in mmWave band.	500 Mbps with 400 MHz radio channel in mmWave band.

User-achievable rates and additional details on typical rates are covered in the appendix section "Data Throughput."

3GPP develops specifications in releases, with each release addressing multiple technologies. For example, Release 8 not only defined dual-carrier operation for HSPA, but also introduced LTE. Similarly, Release 15 both augmented LTE capability and introduced 5G. Each release adds new features and improves performance of existing functionality in different ways. Table 16 summarizes some key features of different 3GPP releases.

---

<sup>184</sup> "5+5 MHz" means 5 MHz used for the downlink and 5 MHz used for the uplink.

<sup>185</sup> 5G Americas member company analysis for downlink and uplink. Assumes single user with 50% load in other sectors. AT&T and Verizon are quoting typical user rates of 5-12 Mbps on the downlink and 2-5 Mbps on the uplink for their networks. See additional LTE throughput information in the section below, "LTE Throughput."

**Table 16: Key Features in 3GPP Releases<sup>186</sup>**

Release	Year	Key Features
99	1999	First deployable version of UMTS.
5	2002	High Speed Downlink Packet Access (HSDPA) for UMTS.
6	2005	High Speed Uplink Packet Access (HSUPA) for UMTS.
7	2008	HSPA+ with higher-order modulation and MIMO.
8	2009	Long Term Evolution. Dual-carrier HSDPA.
10	2011	LTE-Advanced, including carrier aggregation and eICIC.
11	2013	Coordinated Multi Point (CoMP).
12	2015	Public safety support. Device-to-device communications. Dual Connectivity. 256 QAM on the downlink.
13	2016	LTE-Advanced Pro features. LTE operation in unlicensed bands using LAA. Full-dimension MIMO. LTE-WLAN Aggregation. Narrowband Internet of Things.
14	2017	LTE-Advanced Pro additional features, such as eLAA (adding uplink to LAA) and cellular V2X communications. Study item for 5G "New Radio."
15	2018	Additional LTE-Advanced Pro features, such as ultra-reliable low-latency communications and high-accuracy positioning. Phase 1 of 5G. Emphasizes enhanced mobile broadband use case and operation to 52.6 GHz. Includes Massive MIMO, beamforming, and 4G-5G interworking, including ability for LTE connectivity to a 5G CN.
16	2020	Phase 2 of 5G. Full compliance with ITU IMT-2020 requirements. Adds URLLC, IAB, unlicensed operation, NR-based C-V2X, positioning, dual-connectivity, carrier aggregation, and multiple other enhancements.
17	2021	NR-Light, NR operation 52.6-71 GHz, multiple SIMs, NR multicast and broadcast, non-terrestrial networks, and multiple enhancements.

For a more detailed listing of features in each 3GPP release, refer to the sections "5G Phase One (Release 15)" and "5G Phase Two (Release 16)" above, as well as the appendix section "3GPP Releases."

## Fixed Wireless Access

As wireless capability has improved, many applications that previously used wired connections have shifted to wireless connections. Examples include wireline telephony moving to mobile telephony, Ethernet to Wi-Fi, and now Digital Subscriber Line (DSL) and coax cable to fixed wireless and satellite systems. Particularly in rural areas, wireless technologies can be built at a fraction of the cost of wired networks, extending broadband to more people. A board

---

<sup>186</sup> After Release 99, release versions went to a numerical designation beginning with Release 4, instead of designation by year.

member of the Wireless Internet Service Provider Association stated that wireless costs are one-fifth to one-tenth that of cable or fiber.<sup>187</sup>

Figure 53 shows the characteristics of three forms of wireless connections: mobile wireless, fixed wireless, and satellite. Fixed wireless connections have more stable connections and predictable load than mobile wireless connections, so broadband speeds vary less.

**Figure 53: Types of Connections**

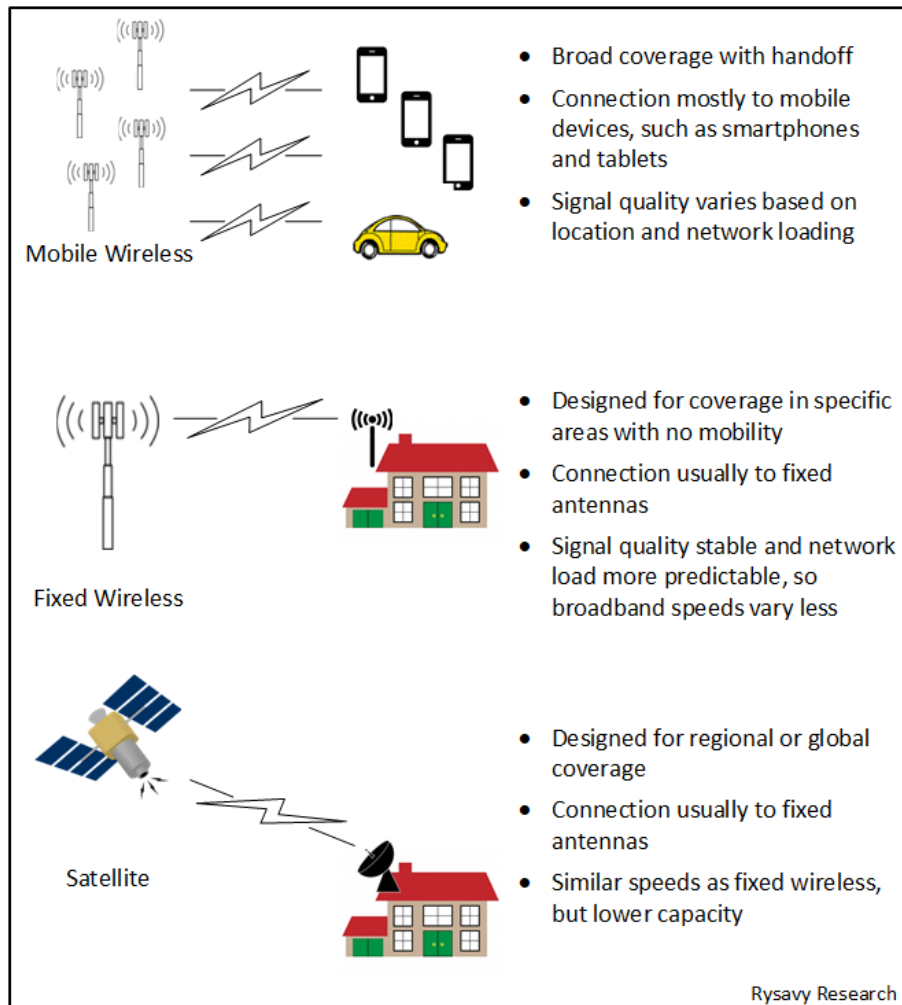

Broadband networks rely on a fiber core with various access technologies, such as fiber to the premises, coaxial cable, digital subscriber line (DSL), or wireless connections. LTE provides a broadband experience, but capacity limitations prevent it from being the only broadband connection for most users. As a result, a majority of consumers in developed countries have both mobile broadband and fixed broadband accounts.

Multiple developments are transforming the current situation:

---

<sup>187</sup> BroadbandBreakfast.com, "Wireless Internet Service Providers Pitch Fixed Wireless Technology in Forthcoming Infrastructure Bill," Oct. 2017. <http://broadbandbreakfast.com/2017/10/wireless-internet-service-providers-pitch-fixed-wireless-technology-in-forthcoming-infrastructure-bill/>.

- ❑ **Fiber Densification.** Multiple companies are investing to extend the reach of fiber, decreasing the distance from the fiber network to the end node.
- ❑ **5G Standardization and Deployment.** As 5G mmWave technology, including massive MIMO and beamforming, becomes commoditized, it will increasingly be a viable alternative to fixed-access technologies such as coaxial, DSL, and even fiber connections.

Consequently, the companies that provide broadband service may change, and eventually, fixed and mobile broadband services may converge. For a more detailed discussion of trends in broadband, including the disruptive role of mmWave, refer to the 2018 Datacomm Research and Rysavy Research report, *Broadband Disruption: How 5G Will Reshape the Competitive Landscape*.<sup>188</sup>

As shown in Figure 54, the emerging wireless network is one with denser fiber and competing access technologies in which wireless connectivity plays a larger role.

**Figure 54: Fiber Densification with Multiple Access Technologies, Including mmWave**

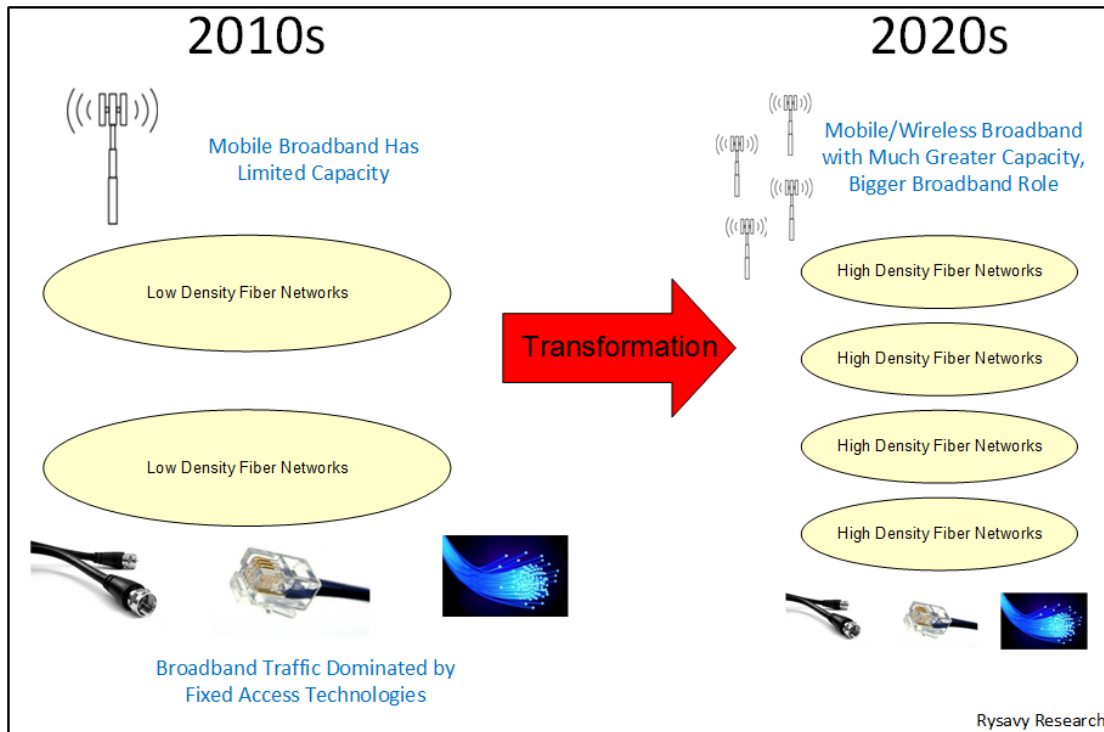

Rysavy Research analysis shows that wireless networks with access to 100 MHz or more spectrum can compete with or even exceed the capacity of Hybrid Fiber Coaxial (HFC) networks, although HFC networks can also densify to increase capacity. Densifying either a mmWave network or HFC network means moving fiber closer to homes. With access to comparable amounts of spectrum and similar spectral efficiencies, mmWave networks

<sup>188</sup> Details at <https://datacommresearch.com/reports-broadband/>.

(supplemented with IAB) and HFC networks will achieve similar capacity relative to the distance of fiber from the endpoint.

LTE, and especially 5G, will also play an important role in rural broadband, with a variety of spectrum bands coming into service. For many rural scenarios, lower bands with higher coverage will play a key role, particularly 5G using bands below 6 GHz. Cellular operators, whose licenses for spectrum are driven by urban capacity demands, may have lightly used spectrum assets in less dense areas that they could use for fixed wireless service. Unlicensed 5 GHz bands will also continue to play a role. CBRS, which spans from 3.55 to 3.70 GHz, could be an important solution for rural broadband; so will the forthcoming 280 MHz of C-Band spectrum, as discussed below in the section "Spectrum Developments."

For fixed wireless access, customer premise equipment will vary depending on radio band and signal quality, but it will consist of one of the following: an indoor device, an indoor window-mounted device, an outdoor wall-mounted device installed either by the user or a technician, or an outdoor roof-mounted device installed by a technician.<sup>189</sup>

## **VoLTE, 5G Voice, RCS, WebRTC, and Wi-Fi Calling**

Voice has evolved from a separate circuit-switched service in 2G and 3G networks to a packet-switched service in 4G LTE networks that can integrate with other services and applications, such as messaging and video calling. Elements that make these capabilities possible include the quality-of-service mechanisms in LTE, the IMS platform discussed above, implementation of Rich Communications Suite, compliance with GSMA IR.92 guidelines, and optional support for WebRTC.

### ***Voice Support and VoLTE***

While 2G and 3G technologies were deployed from the beginning with both voice and data capabilities, LTE networks can be deployed with or without voice support. Moreover, there are two methods available: circuit-switched fallback (CSFB) to 2G/3G and VoIP. Most operators deployed LTE using CSFB initially but have since migrated to VoIP methods with VoLTE, which uses IMS. Initial VoLTE deployments occurred in 2012.

For the time being, 3GPP operators with UMTS/HSPA networks will continue to use circuit-switched voice for their 3G connections.

Using VoLTE, operators can offer high-definition (HD) voice using the new Adaptive Multi-Rate Wideband (AMR-WB) voice codec. HD voice not only improves voice clarity and intelligibility, it suppresses background noise. AMR-WB extends audio bandwidth to 50-7000 Hz compared with the narrowband codec that provides audio bandwidth of 80-3700 Hz. HD voice will initially function only between callers on the same network. 3GPP has also developed a new voice codec, called "Enhanced Voice Services" (EVS), which will be the successor to AMR and AMR-WB codecs.

Other advantages of LTE's packetized voice include being able to combine it with other services, such as video calling and presence, half the call set-up time of a 3G connection, and high voice spectral efficiency. With VoLTE's HD voice quality, lower delay, and higher

---

<sup>189</sup> For example, see Venture Beat, "Verizon's new 5G home router has Wi-Fi 6, Alexa, and self-setup option," Oct. 21, 2019. <https://venturebeat.com/2019/10/21/verizons-new-5g-home-router-has-wi-fi-6-alexa-and-self-setup-option/>.

capacity, operators can compete against OTT VoIP providers. Due to traffic prioritization, VoLTE voice quality remains high even under heavy loads that cause OTT-voice service to deteriorate.

Applications based on WebRTC will also increasingly carry voice sessions. See the appendix section "VoLTE and RCS" for more details on LTE voice support.

## **5G Voice Support**

5G NR can provide voice service via IMS, the infrastructure that today supports VoLTE, as explained in the appendix section "IP Multimedia Subsystem."<sup>190</sup> In early deployments, 5G phones will have simultaneous 4G and 5G connections (using dual connectivity), and voice calls will be handled by the LTE connection.

## **Rich Communications Suite**

An initiative called "Rich Communications Suite" (RCS), supported by many operators and vendors, builds on IMS technology to provide a consistent feature set as well as implementation guidelines, use cases, and reference implementations. RCS uses existing standards and specifications from 3GPP, Open Mobile Alliance (OMA), and GSMA, and enables interoperability of supported features across operators that support the suite. RCS supports both circuit-switched and packet-switched voice and can interoperate with LTE packet voice.

Core features include:

- ❑ A user capability exchange or service discovery with which users can know the capabilities of other users.
- ❑ Enhanced (IP-based) messaging (supporting text, IM, and multimedia) with chat and messaging history.
- ❑ Enriched calls that include multimedia content (such as photo or video sharing) during voice calls. This could become the primary way operators offer video calling.

The primary drivers for RCS adoption are the ability to deploy VoLTE in a well-defined manner and to support messaging in the IP domain. RCS addresses the market trend of users moving away from traditional text-based messaging and provides a platform for operator-based services that compete with OTT messaging applications. Figure 55 shows the evolution of RCS capability, including the addition of such features as messaging across multiple devices, video calling, video sharing, and synchronized contact information across multiple devices.

---

<sup>190</sup> For further information, see Ericsson, "Mobile network ready for 5G voice."  
<https://www.ericsson.com/en/digital-services/voice-services/5g-voice>.



**Figure 55: Evolution of RCS Capability.<sup>191</sup>**

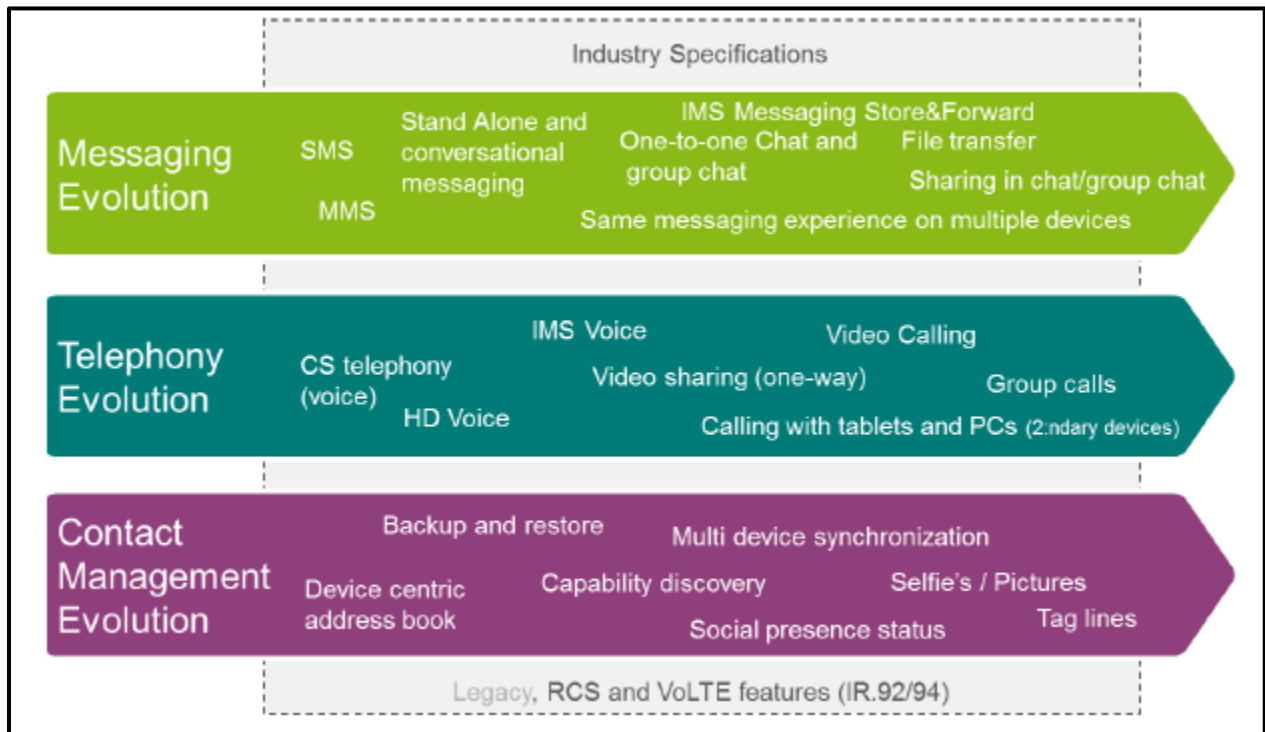

## WebRTC

WebRTC is an open project supported by Google, Mozilla, and Opera within the Internet Engineering Taskforce (IETF) that enables real-time communications in Web browsers via JavaScript APIs. 3GPP Release 12 specifications define how WebRTC clients can access IMS services, including packet voice and video communication. WebRTC operating over IMS gains the additional benefit of seamless transition across transport networks, for example, LTE to Wi-Fi.

Operators can integrate WebRTC with RTC, facilitating development of vertical applications such as telemedicine and customer service. WebRTC and RCS are more complementary than competitive; both, through application interfaces, can provide access to underlying network functions.

## Wi-Fi Calling

Another advantage of the VoLTE/IMS/RCS architecture is that it is agnostic to the user connection, meaning voice and video service can extend to Wi-Fi connections as easily as LTE connections. Wi-Fi calling can be advantageous in coverage areas where the Wi-Fi signal has better quality than an LTE signal. For video calling, use of Wi-Fi will also reduce data consumption over the cellular connection. By implementing a standards-based approach, as opposed to OTT-voice approaches, called parties see the same phone number regardless of network and can reach the subscriber using that phone number.

<sup>191</sup> 4G Americas, *VoLTE and RCS Technology - Evolution and Ecosystem*, Nov. 2014.

Previous technical approaches, such as Generic Access Network (GAN, initially called Unlicensed Mobile Access [UMA]), did not include as robust a handover mechanism as VoLTE/IMS provides.

For the best quality voice in a Wi-Fi network, the device and Wi-Fi network should implement Wi-Fi Multimedia (WMM), which gives voice packets higher priority than other data traffic. WMM is especially necessary in congested networks. In addition, the Access Network Discovery and Selection Function (ANDSF) and cellular-WLAN enhancement features in 3GPP Release 12 have policies for enabling voice handover between LTE and Wi-Fi.

Roaming with Wi-Fi calling must address whether the visited network's IMS or the home network's IMS infrastructure handles the Wi-Fi call.

## Public Safety

Historically, public safety has used land mobile radio (LMR) technologies, such as Terrestrial Trunked Radio (TETRA) in Europe and Project 25 (P25) in the U.S., for mission-critical voice service.<sup>192</sup> In the last few years, public safety in the U.S. made a significant shift to LTE for data and voice services. Public safety has relied on cellular voice services from commercial cellular networks for many years, including push-to-talk, which is now available in mission-critical form using LTE.

Public safety also leverages apps for daily first responder use on existing commercial networks and can now use them on reliable, prioritized, and preemptable LTE-based public-safety wireless broadband networks.

In the U.S., the government made 20 MHz of spectrum available at 700 MHz in Band 14 and created the First Responder Network Authority (FirstNet Authority, <https://www.firstnet.gov/>). This independent authority has a singular mission: to enter into a public-private partnership and ensure the development, build, operation, and upgrade of the nationwide public-safety broadband network, now known as FirstNet. FirstNet equipped first responders with reliable and secure broadband capabilities to save lives and protect U.S. communities.

In 2017, the FirstNet Authority announced its partnership with AT&T, which was competitively awarded the contract to build, upgrade, and manage this network that currently provides real-time, always-on, priority and preemption, with end-to-end encryption to first responders across the U.S. and its territories. Since the award, AT&T has been deploying Band 14, as well as using all of its more-than-100 MHz of currently deployed, commercially available LTE spectrum, controlled by a dedicated public safety core network.

More than 650 markets are deployed with Band 14, and AT&T reported in January 2020 that 80% of the buildout was about to be completed.<sup>193</sup> Some 12,000 public safety agencies

---

<sup>192</sup> Updates in 2019 to this section courtesy of The Public Safety Network, <http://www.publicsafety.network>.

<sup>193</sup> IWCE's Urgent Communications, "AT&T to finish 80% of FirstNet buildout in coming months, exec says," Jan. 31, 2020. <https://urgentcomm.com/2020/01/31/att-to-finish-80-of-firstnet-buildout-in-coming-months-exec-says/>.

currently use AT&T/FirstNet, encompassing 1.3 million connections.<sup>194</sup> AT&T has also indicated it is in the process of updating FirstNet to 5G.<sup>195</sup>

There are more than seventy-five FirstNet devices, more than fifty unique apps in the FirstNet app catalog, and seventy-five dedicated deployable network assets, including three Flying COWs™. AT&T and Assured Wireless Corporation are working together to develop high-power user equipment (HPUE). Following 3GPP standards, HPUE solutions can transmit at stronger signals. This signal increase can only be done using the FirstNet Band 14 spectrum. For rural and remote responders, HPUE could significantly increase their coverage area. For urban and suburban responders, HPUE will help solve the challenge of indoor coverage. The stronger signal will better assist those connecting from hard-to-reach places such as basements, elevators, stairwells, and parking garages, helping first responders communicate inside and out.

Other countries across the world are at various stages of planning and implementing similar public safety LTE networks, including New Zealand, South Korea, Japan, the United Kingdom, Finland, Norway, and several European countries.

Using LTE for public safety is a complex undertaking because the needs of public safety reliability differ from those of consumers. Addressing these needs requires both different features, which 3GPP is incorporating in multiple releases of LTE specifications, and different network deployment approaches. Public safety also has device and application needs beyond those of traditional consumers.

## ***LTE Features for Public Safety***

Some broadband applications for public safety can use standard LTE capability. For example, sending email, accessing a database, or streaming a video may not require any special features. Other applications, however, require new capabilities from 3GPP standards, including:

### **Group Communication**

Available in Release 12, the Group Communication Service (GCS) application server, using one-to-one (unicast) and one-to-many communications (broadcast), will be able to send voice, video, or data traffic to multiple public-safety devices. The broadcast mode will employ eMBMS to use radio resources efficiently, but if coverage is weak, a unicast approach may deliver data more reliably. The system will be able to dynamically switch between broadcast and unicast modes. Release 14 adds single-cell point-to-multipoint transmission.

### **Proximity-Based Services (Device-to-Device)**

With proximity-based services, defined in Release 12, user devices can communicate directly, a capability that benefits both consumers and public safety. This type of communication is called sidelink communication. Consumer devices can find other devices only with assistance from the network, but for public safety, devices will be able to communicate directly with other devices independently of the network.

---

<sup>194</sup> Fierce Wireless, "AT&T's Elbaz says the carrier plans to transition FirstNet to 5G," Jul. 24, 2020. <https://www.fiercewireless.com/5g/at-t-s-elbaz-says-carrier-plans-to-transition-firstnet-to-5g>.

<sup>195</sup> *Ibid.*

With Release 13, devices can act as relays for out-of-coverage devices, such as those inside a building. The appendix section “Proximity Services (Device-to-Device)” discusses this feature in greater detail.

### **Mission-Critical Push-to-Talk**

MCPTT, defined in Release 13, provides one-to-one and one-to-many push-to-talk communications services. With this now-available feature, public-safety organizations are able to consider using LTE as a primary voice system.

### **Mission-Critical Video over LTE and Mission-Critical Data over LTE**

Release 14 added Mission-Critical Video over LTE and Mission-Critical Data over LTE, designed to work with Mission-Critical Push-to-Talk, giving first responders more communications options.<sup>196</sup> These should be available to end users by the end of 2020.

### **Prioritization**

To prevent interference with public-safety operations in emergency situations experiencing high load, the network can prioritize at multiple levels. First, the network can bar consumer devices from attempting to access the network, thus reducing signaling load. Second, the network can prioritize radio resources, giving public-safety users higher priority. Third, using a new capability called “Multimedia Priority Service” (MPS), the network can prioritize a connection between an emergency worker and a regular subscriber. Finally, the network can assign specific QoS parameters to specific traffic flows, including guaranteed bit rate. 3GPP has defined specific QoS quality-class identifiers for public safety.

### **High Power User Equipment**

Release 11 defined higher-power devices for the public safety band that can operate at 1.25 watts. At approximately six times the power of commercially available devices, this release improves network coverage and penetration, and provides the ability to rely on cloud services for public safety operations.

### **Isolated Operation**

With Release 13, a base station can continue offering service even with the loss of backhaul, a capability that will benefit public-safety personnel in disaster situations.

### **Relays**

Figure 56 summarizes the more than eighteen features in 3GPP relays that apply to public safety.

---

<sup>196</sup> For details, see 3GPP, “Mission Critical Services in 3GPP,” Jun. 20, 2017. [http://www.3gpp.org/NEWS-EVENTS/3GPP-NEWS/1875-MC\\_SERVICES](http://www.3gpp.org/NEWS-EVENTS/3GPP-NEWS/1875-MC_SERVICES), viewed May 31, 2018.

**Figure 56: Summary of 3GPP LTE Features to Support Public Safety<sup>197</sup>**

3GPP Rel-8	3GPP Rel-9	3GPP Rel-10	3GPP Rel-11	3GPP Rel-12	3GPP Rel-13
<ul style="list-style-type: none"> <li>• Mobile data connections</li> <li>• Basic support for Voice over LTE (telephony)</li> <li>• Support for LTE Band 14</li> <li>• a rich set of QoS priority and pre-emption features</li> <li>• Highly secure authentication and ciphering</li> </ul>	<ul style="list-style-type: none"> <li>• Location services and positioning support for LTE</li> <li>• Multimedia Broadcast / Multicast Service</li> <li>• E911 or emergency calling support</li> <li>• Enhanced Home LTE base station: "Cell On Wheels"</li> <li>• Self-Organizing Networks (SONs)</li> </ul>	<ul style="list-style-type: none"> <li>• Physical layer enhancements to increase data throughput (including LTE-Advanced features)</li> <li>• Relays for LTE, e.g. to allow a base station mounted on a fire vehicle to relay communications from firefighters in a basement back to the network.</li> </ul>	<ul style="list-style-type: none"> <li>• High power devices for Band 14 - 1.25 Watts for public safety devices significantly improving the coverage of an LTE network, benefiting public safety users and reducing network deployment costs.</li> </ul>	<ul style="list-style-type: none"> <li>• Group Communication System Enablers for LTE</li> <li>• Proximity-based Services</li> </ul> <p>3GPP work ongoing - completion expected 1Q2015</p>	<ul style="list-style-type: none"> <li>• Mission Critical Push-to-Talk</li> <li>• Enhancements to Proximity-based Services</li> <li>• Isolated E-UTRAN Operation for Public Safety</li> <li>• MBMS Enhancements</li> </ul> <p>3GPP work started - completion expected 2016</p>

## Deployment Approaches

Because huge infrastructure investments would be required for a network built solely for public safety, industry and governments are evaluating different approaches. These include public-private partnerships such as FirstNet, in which public safety users can leverage existing commercial network deployments but with the added features of priority, preemption, and encryption, enabled by a public safety core.

FirstNet is an example of an approach that provides nationwide coverage with a public safety application ecosystem. Use of existing commercial infrastructure will likely be critical to the success of many other public safety networks, but given that public safety users have more stringent reliability, resilience, security, and coverage objectives than commercial users, existing networks will need to be adapted and augmented accordingly.

### Shared Network

As depicted in Figure 57, multiple sharing approaches are possible:

- ❑ In this scenario, a public-safety entity owns and operates the entire network, an approach that gives public-safety organizations the greatest control over the network but at the highest cost.
- ❑ A commercial operator shares its radio-access network for a price, including cell sites and backhaul, but the public-safety entity manages core network functions including gateways, the Mobile Management Entity, the Home Subscriber Server (HSS), and public-safety application servers. Spectrum can be a combination of commercial spectrum and/or spectrum dedicated to public safety. Because the radio-access network is the costliest part of the network, this approach significantly reduces the amount of capital expense that public safety must invest in the network. Even though the RAN is shared, public-safety users can use the network with higher priority.

<sup>197</sup> Nokia, *LTE networks for public safety services*, 2014.

[http://networks.nokia.com/sites/default/files/document/nokia\\_lte\\_for\\_public\\_safety\\_white\\_paper.pdf](http://networks.nokia.com/sites/default/files/document/nokia_lte_for_public_safety_white_paper.pdf).

- ❑ In an MVNO approach, the operator shares its cell sites and backhaul as well as some core network functions, such as the MME and Serving Gateway. Public safety manages a small number of network functions, such as the Packet Gateway, HSS, and its application servers.
- ❑ Another approach, not shown in the figure, is one in which the mobile operator hosts all of the elements shown in the figure, and public safety manages only its application servers.
- ❑ A fifth approach, not shown in the figure, is the U.S. FirstNet model of a true public-private partnership. In this model, carriers compete against each other, addressing service level agreements, capabilities, capacities, and schedules, thus driving the greatest capability for the lowest cost. This approach enables operators to create added benefits to their commercial activities while providing specified services for public safety. Because this approach leverages existing cellular infrastructure, public safety services can be deployed quickly. System integration, network deployment, management, and operational risks shift away from the government to the operator, which is better qualified to perform such functions.

**Figure 57: Sharing Approaches for Public Safety Networks**

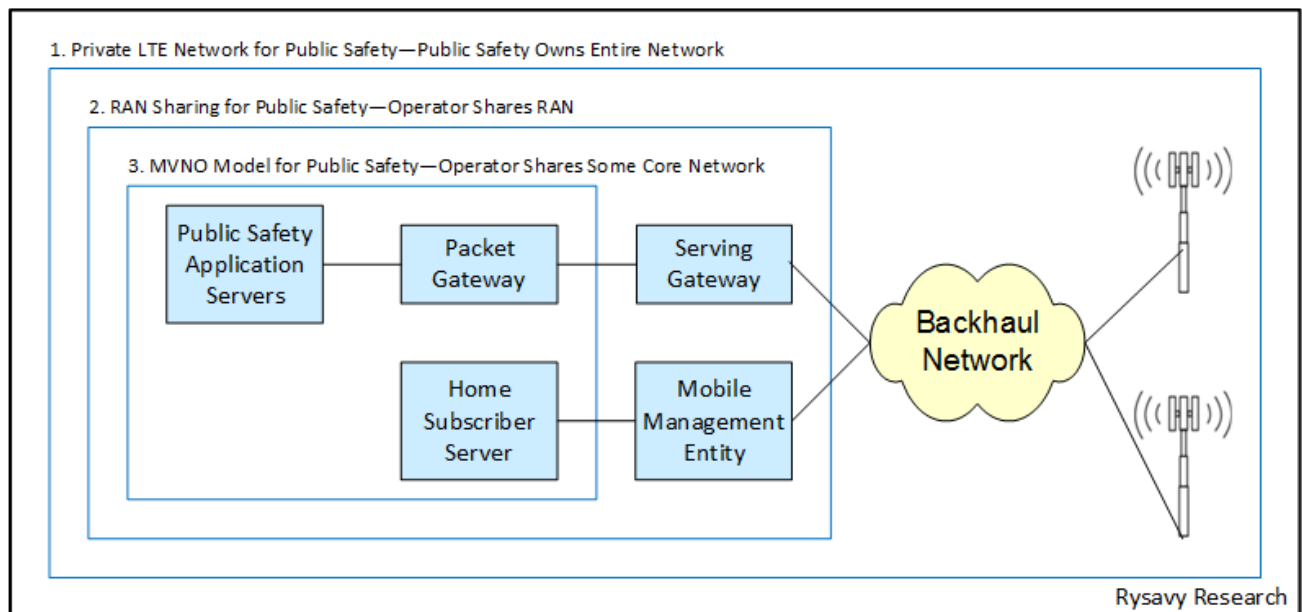

### Reliability

Public safety requires always-on connectivity with priority and preemption, now possible with the advent of public safety LTE networks such as FirstNet. The unguaranteed connectivity of a commercial LTE network can mean the difference between life and death for first responders and those in the communities they serve.

### Resilience

Public safety needs greater resilience than found in commercial networks, including hardware redundancy, geographic redundancy, load balancing, fast rerouting in IP networks, interface protection, outage detection, self-healing, automatic reconfiguration, and rapid service re-constitution.

## Security

Public-safety networks have high security requirements, including physical security of data centers, core sites, and cell sites. Whereas commercial LTE networks do not have to encrypt traffic in backhaul and core networks, public safety networks may choose to encrypt IP traffic using virtual private networking approaches.

## Coverage

A number of approaches can ensure the broadest possible coverage for public-safety networks. First, public-safety frequencies sub 1 GHz already propagate and penetrate well. Next, high power user equipment for public safety provide better rural coverage at the network's edge and greater penetration in urban environments, such as parking garages. In addition, base stations can employ four-way receiver diversity and higher-order sectorization. For high-volume planned-event and disaster scenarios, public safety can use deployables, such as cell on wheels and cell on wings (both known as COWs) and cell on light trucks (COLTs). These provide greater resilience in addition to improved coverage. Finally, proximity-based services operating in a relay mode, as discussed above, can extend coverage.

# Expanding Capacity

Wireless technology plays a profound role in networking and communications, even though wireline technologies such as fiber have inherent capacity advantages.

Over time, wireless networks will gain substantial additional capacity through the methods discussed in the next section. While they will compete with copper twisted pair and coax, they will never catch up to fiber. The infrared frequencies used in fiber-optic communications have far greater bandwidth than radio. As a result, one fiber-optic strand has greater bandwidth than the entire usable radio spectrum to 100 GHz, as illustrated in Figure 58.<sup>198</sup>

---

<sup>198</sup> One fiber-optic cable can transmit over 10,000 Gbps compared with all wireless spectrum to 100 GHz, which, even at an extremely high spectral efficiency 10 bps/Hz, would have only 1,000 Gbps of capacity.

**Figure 58: RF Capacity vs. Fiber-Optic Cable Capacity**

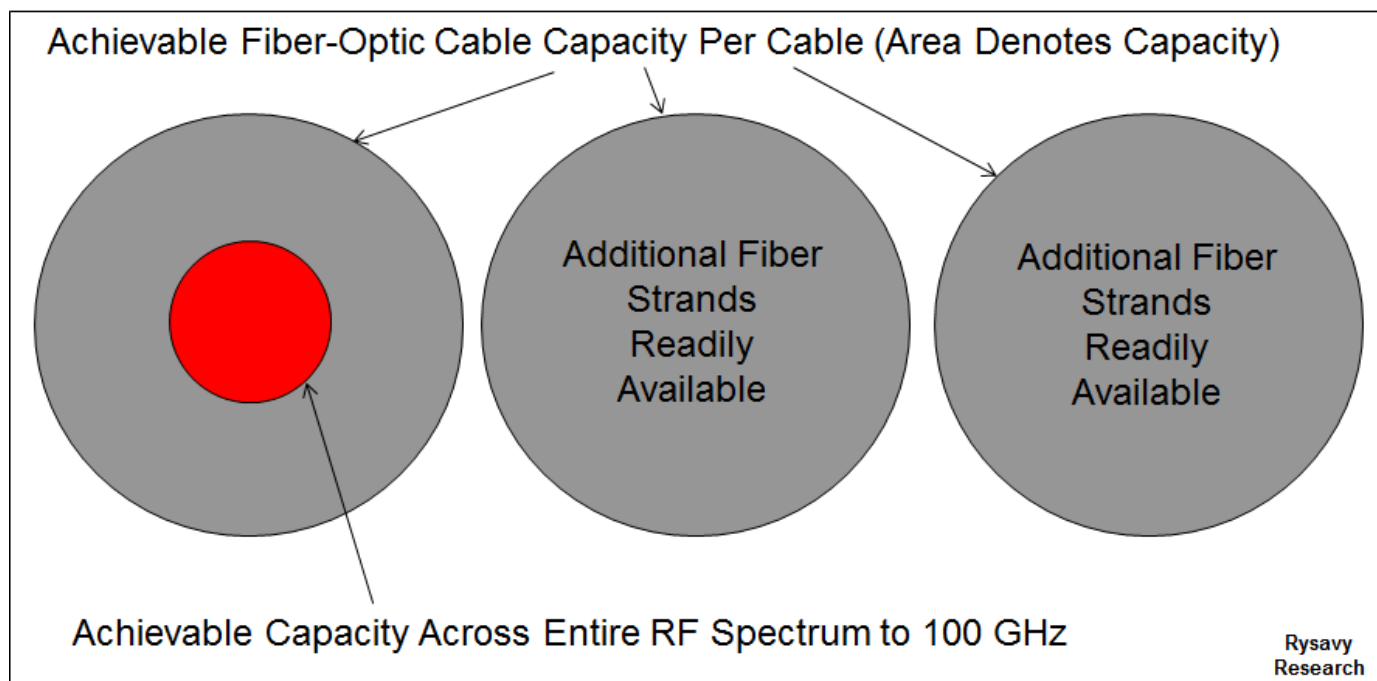

A dilemma of 4G mobile broadband is that it *can* provide a broadband experience similar to wireline, but it *cannot* do so for all subscribers in a coverage area at the same time. Hence, operators must carefully manage capacity, demand, policies, pricing plans, and user expectations. Similarly, application developers must become more conscious of the inherent constraints of wireless networks. 5G, with its far greater capacity, will be the first generation of cellular technology that can be an effective wireline replacement for a large percentage of subscribers. Such capability, however, will typically require small cells using mmWave, especially in urban areas.

As shown in Figure 59, three factors determine wireless network capacity: the amount of spectrum, the spectral efficiency of the technology, and the size of the cell. Because smaller cells serve fewer people in each cell and because of their greater number, small cells are a major contributor to increased capacity.



**Figure 59: Dimensions of Capacity**

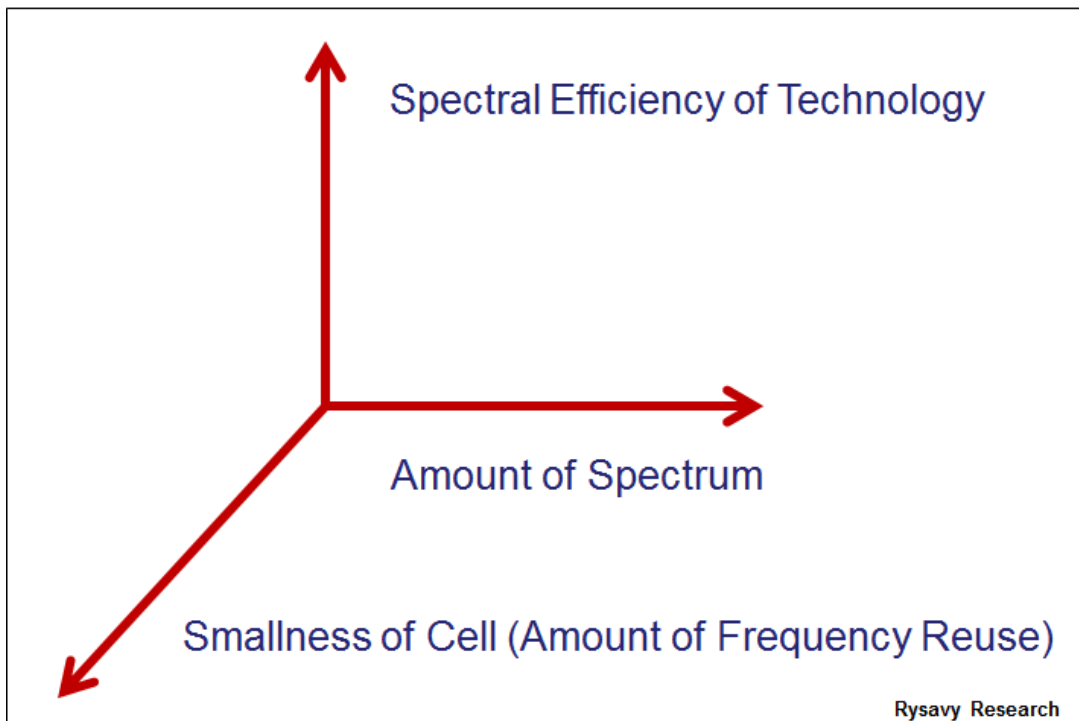

Given the relentless growth in usage, mobile operators are combining multiple approaches to increase capacity and managing congestion:

- ❑ **More spectrum.** Spectrum correlates almost directly to capacity, and more spectrum is becoming available globally for mobile broadband. mmWave band spectrum for 5G will provide far more spectrum, but propagation characteristics will restrict its use to small cells. Multiple papers by Rysavy Research and others<sup>199</sup> argue the critical need for additional spectrum.
- ❑ **Unpaired spectrum.** LTE TDD operates in unpaired spectrum. In addition, technologies such as HSPA+ and LTE permit the use of different amounts of spectrum between downlink and uplink. Additional unpaired downlink spectrum can be combined with paired spectrum to increase capacity and user throughputs.
- ❑ **Supplemental downlink.** With downlink traffic five to ten times greater than uplink traffic, operators often need to expand downlink capacity rather than uplink capacity. Using carrier aggregation, operators can augment downlink capacity by combining separate radio channels.
- ❑ **Spectrum sharing.** Policy makers are evaluating how spectrum might be shared between government and commercial entities. Although a potentially promising approach for the long term, sharing raises complex issues, as discussed further in the section "Spectrum Developments."
- ❑ **Increased spectral efficiency.** Newer technologies are spectrally more efficient, meaning greater aggregate throughput using the same amount of spectrum. LTE is

---

<sup>199</sup> See multiple papers on spectrum and capacity at <http://www.rysavvy.com/writing>.

more efficient than WCDMA/HSPA, and 5G is more efficient than LTE. See the section "Spectral Efficiency" for further discussion.

- ❑ **Smart antennas.** Through higher-order MIMO and beamforming, smart antennas gain added sophistication in each 3GPP release and are the primary contributor to increased spectral efficiency (bps/Hz). Massive MIMO, beginning in Release 13, will support 16-antenna-element systems and in 5G, will expand to hundreds of antenna elements.
- ❑ **Uplink gains combined with downlink carrier aggregation.** Operators can increase network capacity by applying new receive technologies at the base station (for example, large-scale antenna systems such as massive MIMO) that do not necessarily require standards support. Combined with carrier aggregation on the downlink, these receive technologies produce a high-capacity balanced network, suggesting that regulators should, in some cases, consider licensing only downlink spectrum.
- ❑ **Small cells and heterogeneous networks.** Selective addition of picocells to macro cells to address localized demand can significantly boost overall capacity, with a linear increase in capacity relative to the number of small cells. HetNets, which can include femtocells, hold the promise of increasing capacity gains by a factor of four and even higher with the introduction of interference cancellation in devices. Distributed antenna systems (DAS), used principally for improved indoor coverage, can also function like small cells and increase capacity. Actual gain will depend on a number of factors, including number and placement of small cells,<sup>200</sup> user distribution, and any small-cell selection bias that might be applied.
- ❑ **Offload to unlicensed spectrum.** Using unlicensed spectrum with Wi-Fi or LTE operation in unlicensed spectrum offers another means of offloading heavy traffic. Unlicensed spectrum favors smaller coverage areas because interference can be better managed, so spectral re-use is high, resulting in significant capacity gains.
- ❑ **Higher level sectorization.** For some base stations, despite the more complex configuration involved, six sectors can prove advantageous versus the more traditional three sectors, deployed either in a 6X1 horizontal plane or 3X2 vertical plane.<sup>201</sup>

Strategies to manage demand include:

- ❑ **Quality of service (QoS) management.** Through prioritization, certain traffic, such as non-time-critical downloads, could occur with lower priority, thus not affecting other active users.
- ❑ **Off-peak hours.** Operators could offer user incentives or perhaps fewer restrictions on large data transfers during off-peak hours.

Based on historical increases in the availability of new spectrum, technologies delivering better spectral efficiency, and increases in the number of cell sites, Rysavy Research has calculated that, over the last thirty-year period, aggregate network capacity has doubled every three years. Rysavy Research expects this trend to continue into the future.

---

<sup>200</sup> With small-cell range expansion using a large selection bias, small cells can be distributed uniformly.

<sup>201</sup> An example of vertical layering would be a 3X1 layer at ground level and a separate 3X1 layer for higher levels of surrounding buildings.

# Conclusion

Wireless technology, especially mobile broadband, remains at the forefront of innovation in computing, networking, and application development. As users, applications, services, and now machines consume ever more wireless data, the industry is responding with faster, more efficient, and higher-capacity networks. LTE has become the global standard, but with Release 15 5G networks rolling out globally using multiple spectrum bands, 5G is rapidly rising to become the dominant wireless technologies of the 2020s.

3GPP completed Release 16 in 2020, expanding the scope of 5G capabilities to include IAB, operation in unlicensed spectrum with NR-U, C-V2X, and URLLC. The flexible capabilities of 5G enable a wide range of business models, including fixed-wireless access, enhanced mobile broadband, and IoT support.

Further developing 5G as a platform for innovation, Release 17 will add NR-Light, NR operation in 52.6 to 71 GHz, multiple SIMs, NR multicast and broadcast, and non-terrestrial networks.

By harnessing new spectrum, such as mmWave bands above 24 GHz, 5G will eventually be able to access more than ten times as much spectrum as is currently available for cellular operation. Using radio bands of hundreds of MHz will result in multi-Gbps throughput capabilities. 5G provides operators multiple options to migrate from LTE to 5G. Most operators now are transitioning their networks to standalone architecture to improve performance, enable industrial IoT, and facilitate edge computing.

LTE-Advanced and LTE-Advanced Pro innovations include VoLTE, 1 Gbps peak rate capability, higher-order MIMO, carrier aggregation, LAA/LWA/LWIP, IoT capabilities in Narrowband-IoT and Category M-1, V2X communications, small-cell support, URLLC, SON, dual connectivity, and CoMP—all capabilities that will improve performance, efficiency, and capacity and enable support for new vertical segments.

Carriers are employing virtualization to reduce network costs, improve service velocity, and simplify deployment of new services. Meanwhile, 5G was designed from inception to be implemented in virtualized form. RAN virtualization is now occurring through O-RAN.

Small cells will play an increasingly important role in boosting capacity and will benefit from a number of technologies and developments, including NR-U, SON, eICIC, Dual Connectivity, LTE-LAA, MulteFire, improved backhaul options, and spectrum ideally suited for small cells.

Obtaining more spectrum remains a priority globally. In U.S. markets, the FCC has already conducted multiple mmWave auctions, a CBRS auction in 2020, and is planning a C-band auction at the end of 2020.

The future of wireless technology, including both LTE and 5G, is bright, with no end in sight for continued growth in capability, nor for the limitless application and service innovation that these technologies enable.

## Appendix: Technology Details

The 3GPP family of data technologies provides ever increasing capabilities that support ever more demanding applications. Services obviously need to provide broad coverage and high data throughput. Less obvious for users, but as critical for effective application performance, are the need for low latency, QoS control, and spectral efficiency. Higher spectral efficiency translates to higher average throughputs (and thus more responsive applications) for more active users in a coverage area. The discussion below details the progression of capability for each technology, including throughput, security, latency, QoS, and spectral efficiency.

This appendix provides details on 3GPP releases, 5G, UMTS/HSPA, and EDGE.

### ***Spectral Efficiency***

The evolution of data services is characterized by an increasing number of users with ever-higher bandwidth demands. As the wireless data market grows, deploying wireless technologies with high spectral efficiency is of paramount importance. Keeping all other things equal, including frequency band, amount of spectrum, and cell site spacing, an increase in spectral efficiency translates to a proportional increase in the number of users supported at the same load per user—or, for the same number of users, an increase in throughput available to each user.

Increased spectral efficiency, however, comes at a price because it generally involves greater complexity for both user and base station equipment. Complexity can arise from the increased number of calculations performed to process signals or from additional radio components. Hence, operators and vendors must balance market needs against network and equipment costs. OFDMA technologies, such as LTE and planned 5G approaches, achieve higher spectral efficiency with lower overall complexity, especially in larger bandwidths.

As shown in Figure 60, the link-layer performance of modern wireless technologies is approaching the theoretical limits as defined by the Shannon bound. (The Shannon bound is a theoretical limit to the information transfer rate [per unit bandwidth] that can be supported by any communications link. The bound is a function of the SNRs of the communications link.) Figure 60 also shows that HSDPA, 1xEV-DO, and IEEE 802.16e-2005 are all within 2 to 3 decibels (dB) of the Shannon bound, indicating that there is not much room for improvement from a link-layer perspective.

**Figure 60: Performance Relative to Theoretical Limits for HSDPA, EV-DO, and WiMAX (IEEE 802.16e-2005)<sup>202</sup>**

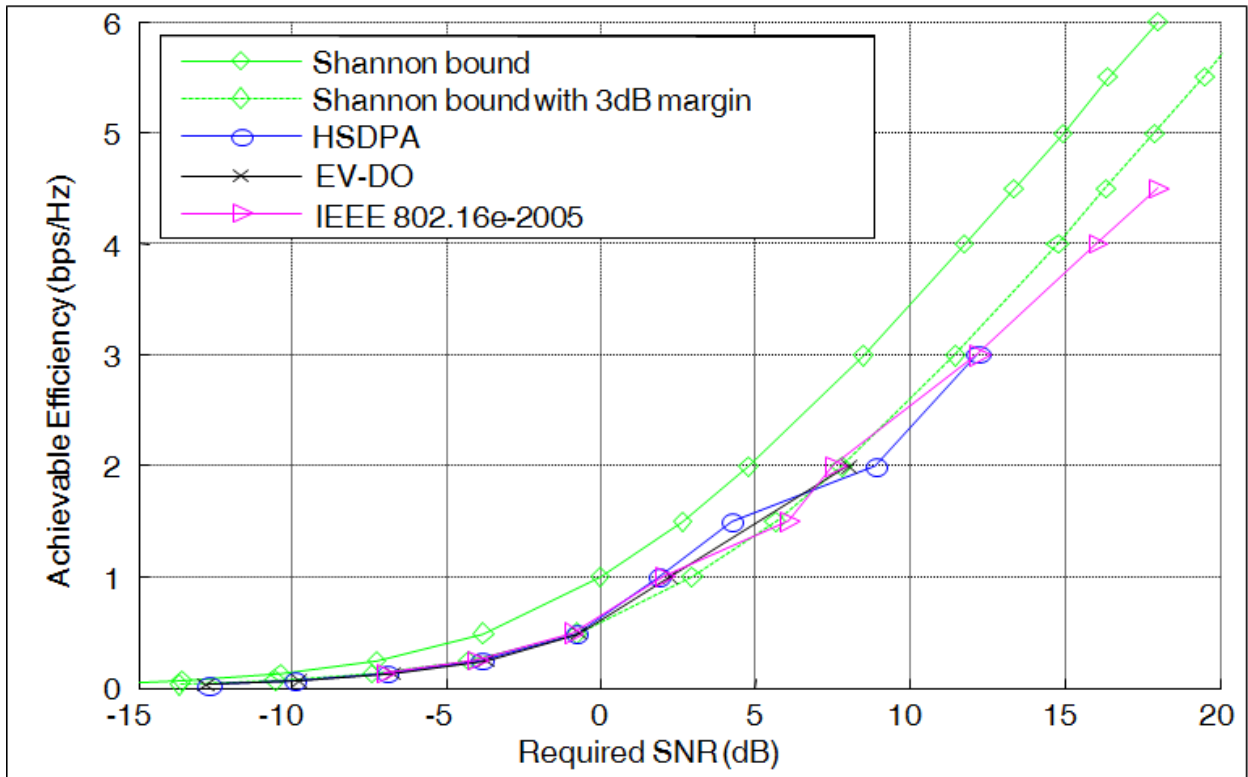

The curves in Figure 60 are for an Additive White Gaussian Noise Channel (AWGN). If the channel is slowly varying and the frame interval is significantly shorter than the coherence time, the effects of fading can be compensated for by practical channel estimation algorithms—thus justifying the AWGN assumption. For instance, at 3 km per hour and fading at 2 GHz, the Doppler spread is about 5.5 Hz. The coherence time of the channel is thus 1 second (sec)/5.5 or 180 msec. Frames are well within the coherence time of the channel, because they are typically 20 msec or less. As such, the channel appears “constant” over a frame, and the Shannon bound applies. Furthermore, significantly more of the traffic in a cellular system is at slow speeds (for example, 3 km/hr. or less) rather than at higher speeds. The Shannon bound is consequently also relevant for a realistic deployment environment.

As the speed of the mobile station increases and the channel estimation becomes less accurate, additional margin is needed. This additional margin, however, would impact the different standards fairly equally.

The focus of future technology enhancements is on improving system performance aspects that reduce interference to maximize the experienced SNRs in the system and antenna

<sup>202</sup> 5G Americas member contribution.

techniques (such as MIMO) that exploit multiple links or steer the beam rather than on investigating new air interfaces that attempt to improve link-layer performance.

MIMO techniques using spatial multiplexing to increase the overall information transfer rate by a factor proportional to the number of transmit or receive antennas do not violate the Shannon bound because the per-antenna transfer rate (that is, the per-communications link transfer rate) is still limited by the Shannon bound.

Figure 61 compares the spectral efficiency of different wireless technologies based on a consensus view of 5G Americas contributors to this paper. It shows the continuing evolution of the capabilities of all the technologies discussed. The values shown are reasonably representative of real-world conditions. Most simulation results produce values under idealized conditions; as such, some of the values shown are lower (for all technologies) than the values indicated in other papers and publications. For instance, 3GPP studies indicate higher HSPA and LTE spectral efficiencies. Nevertheless, there are practical considerations in implementing technologies that can prevent actual deployments from reaching calculated values. Consequently, initial versions of technology may operate at lower levels but then improve over time as designs are optimized. Therefore, readers should interpret the values shown as achievable, but not as the actual values that might be measured in any specific deployed network.

**Figure 61: Comparison of 3G and 4G Downlink Spectral Efficiency<sup>203</sup>**

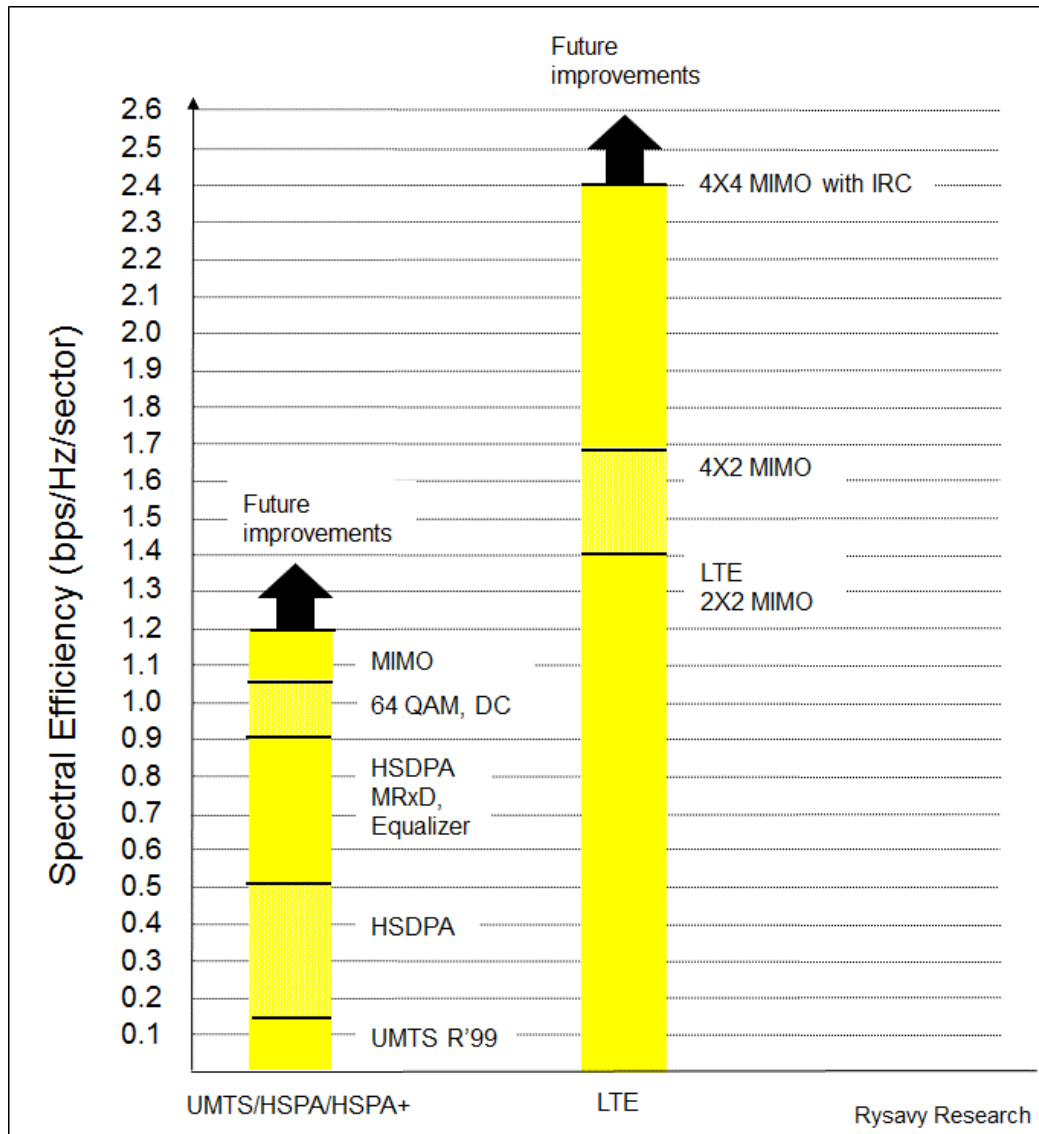

The values shown in Figure 61 are not all possible combinations of available features. Rather, they are representative milestones in ongoing improvements in spectral efficiency. For instance, terminals may employ Mobile Receive Diversity but not equalization.

Relative to WCDMA Release 99, HSDPA increases capacity by almost a factor of three. Type 3 receivers that include MMSE equalization and Mobile Receive Diversity (MRxD) effectively double HSDPA spectral efficiency. The addition of dual-carrier operation and 64 QAM increases spectral efficiency by about 15%, and MIMO can increase spectral efficiency

<sup>203</sup> Joint analysis by 5G Americas members. 5+5 MHz FDD for UMTS-HSPA/LTE. Mix of mobile and stationary users.

by another 15%, reaching 1.2 bps/Hz. Dual-carrier HSPA+ offers a gain in spectral efficiency from cross-carrier scheduling with possible gains of about 10%.<sup>204</sup>

Some enhancements, such as 64 QAM for HSPA, are simpler to deploy than other enhancements, such as 2X2 MIMO. The former can be done as a software upgrade, whereas the latter requires additional hardware at the base station. Thus, the figure does not necessarily show the actual progression of technologies that operators will deploy to increase spectral efficiency.

Beyond HSPA, 3GPP LTE results in further spectral efficiency gains, initially with 2X2 MIMO, then 4X2 MIMO, and then 4X4 MIMO. The gain for 4X2 MIMO will be 20% more than LTE with 2X2 MIMO; the gain for 4X4 MIMO in combination with interference rejection combining (IRC) will be 70% greater than 2X2 MIMO, reaching 2.4 bps/Hz. This value represents a practical deployment of 4X4 MIMO, with random phase and some timing-alignment error included in each of the four transmit paths. CoMP, discussed below in the appendix, provides a minimal contribution to spectral efficiency.

Higher-order MIMO will increase LTE spectral efficiency further. The section, "LTE-Advanced Antenna Technologies" explains that 64X2 MIMO can deliver three times the efficiency of 2X2 MIMO. LTE is even more spectrally efficient when deployed using wider radio channels of 10+10 MHz and 20+20 MHz, although most of the gain is realized at 10+10 MHz. LTE TDD has spectral efficiency that is within 1% or 2% of LTE FDD.<sup>205</sup>

5G will be spectrally more efficient than LTE. The ITU objective was for 5G to be 3 times more spectrally efficient than LTE. Simulations show this is the case when comparing 5G in a massive MIMO configuration, for example 256 base station elements, against LTE in 2X2 or 4X4 MIMO configurations. However, massive MIMO techniques planned for 5G can also be applied to LTE. For the same order of MIMO, simulations show a 25-30% improvement of 5G over LTE, assuming implementation of all possible 5G optimizations.<sup>206</sup>

Simulation studies show 5G can achieve 7.8 bps/Hz of spectral efficiency in dense urban deployments at 4 GHz.<sup>207</sup>

---

<sup>204</sup> 5G Americas member analysis. Vendor estimates for spectral-efficiency gains from dual-carrier operation range from 5% to 20%. Lower spectral efficiency gains are due to full-buffer traffic assumptions. In more realistic operating scenarios, gains will be significantly higher.

<sup>205</sup> Assumes best-effort traffic. Performance between LTE-TDD and FDD differs for real-time traffic for the following reasons: a.) The maximum number of HARQ process should be made as small as possible to reduce the packet re-transmission latency. b.) In FDD, the maximum number of HARQ process is fixed and, as such, the re-transmission latency is 7ms. c.) For TDD, the maximum number of HARQ process depends on the DL: UL configurations. As an example, the re-transmission latency for TDD config-1 is 9ms. d.) Because of higher re-transmission latency, the capacity of real-time services cannot be scaled for TDD from FDD based on the DL:UL ratio.

<sup>206</sup> Nokia presentation, "5G New Radio (NR) Interface for Sub 6 GHz & mmWave Bands," IEEE ICC – 2018, May 22, 2018.

<sup>207</sup> Nokia contribution.



Many of the gains from 5G in mid-band frequencies will be due to the use of Massive MIMO. For instance, A 64T64R antenna configuration can triple the capacity of a cell relative to 4X4 MIMO for both LTE and 5G NR.<sup>208</sup>

Figure 62 shows LTE and NR spectral efficiency at 2 GHz and ISD of 200 meters relative to the number of antenna ports and basic versus advanced configurations.

**Figure 62: LTE and NR Spectral Efficiency at 2 GHz and 200 Meters ISD<sup>209</sup>**

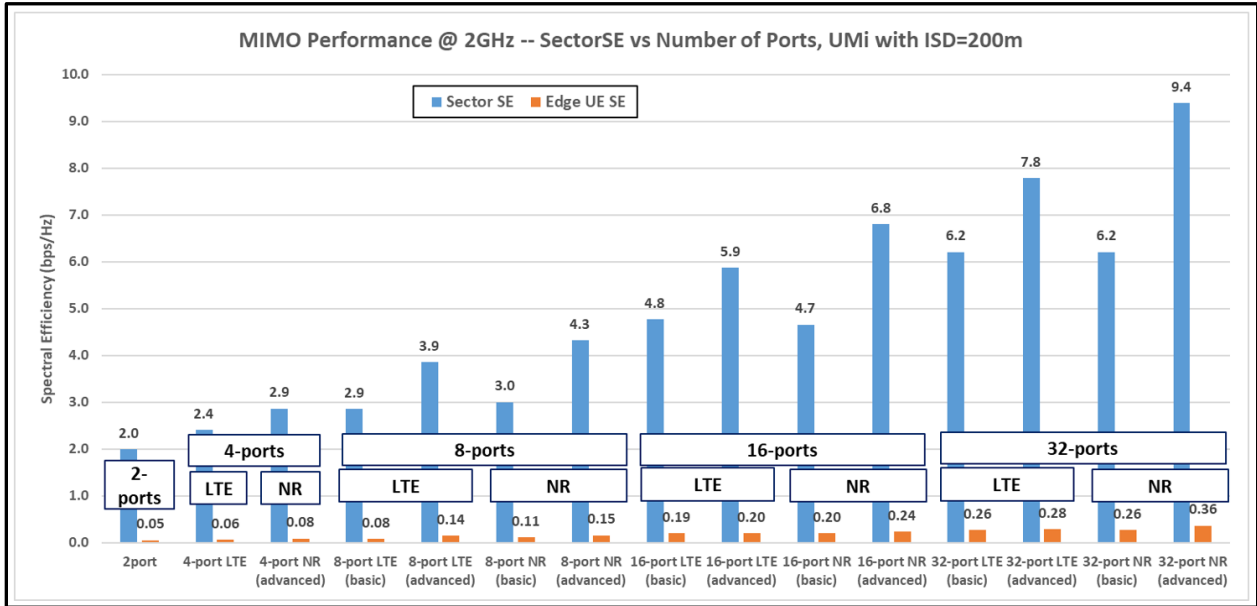

Figure 63 shows the same information but at a larger ISD of 750 meters.

<sup>208</sup> Commscope, *4G and 5G Capacity solutions - comparative study*, July 2019. <https://www.commscope.com/globalassets/digizuite/2154-capacity-solutions-comparative-study-wp-113400-en.pdf?r=1>.

<sup>209</sup> Nokia contribution.

**Figure 63: LTE and NR Spectral Efficiency at 2 GHz and 750 Meters ISD<sup>210</sup>**

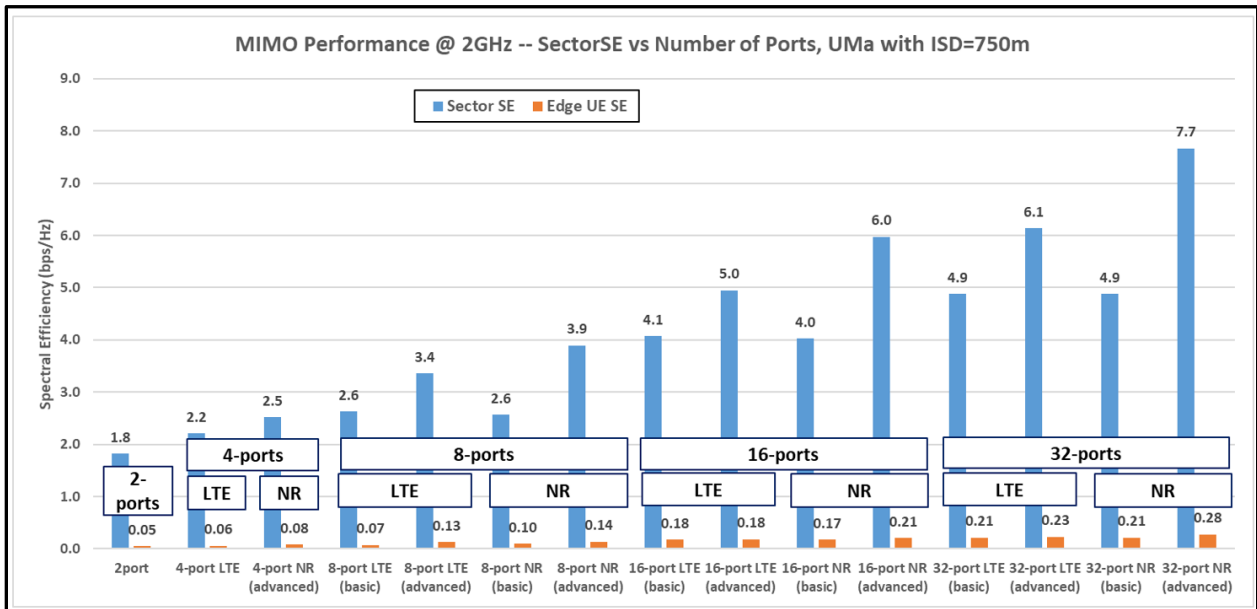

Figure 64 explains the parameters for the spectral efficiency analysis shown in Figure 62 and Figure 63.

**Figure 64: LTE and NR Spectral Efficiency Parameters**

- 3GPP-Style System Level Simulations (7-site deployment with wrap-around)
- Downlink with Full Buffer Traffic (average of 10 UEs per sector)
- Scenarios: 3D-UMi-200m and 3D-UMa-500m, 3D-UMa-750m, 3D-UMa-1500m.
  - Unless otherwise noted, 80% of UEs are indoors, 20% of UEs are outdoors
- Operating band = 2GHz
- UE = 4RX (dual omni XP). UE speeds = 3km/hr
- Array configurations:
  - 2 through 32 TXRU port configurations, 12 rows in physical configuration, all physical elements are 8dBi gain, 65 degree 3dB beamwidth in AZ & EL. Spacing between columns =  $0.5\lambda$ . Spacing between rows =  $0.8\lambda$ .
- Transmit Powers:
  - Total TX power fed to the array is 46dBm
- Transmission schemes:
  - For up to 32 ports: "PMI-oriented transmission based on non-precoded CSI-RS according to the number of ports, UE feeds back RI,CQI,PMI, etc.
- Non-ideal RX, non-ideal CSI-RS-ACQ
- NR and LTE systems are assumed to have the same air-interface overhead
  - Allows us to focus on the impact of MIMO on system performance
  - Any air interface efficiencies that NR has over LTE will scale the NR results accordingly

At mmWave frequencies, 5G systems may initially operate at lower spectral efficiencies than in mid-band frequencies. One simulation analysis by a 5G Americas member indicates a sector spectral efficiency for the downlink, based on four sectors and 200-meter intersite distance, of 4.2 bps/Hz.

<sup>210</sup> Nokia contribution.

Figure 65 presents mmWave spectral efficiency relative to ISD and SU versus MU MIMO, assuming 100% of the channel is dedicated to downlink. For different ratios of downlink to uplink, the spectral efficiency scales linearly.

**Figure 65: mmWave Spectral Efficiency<sup>211</sup>**

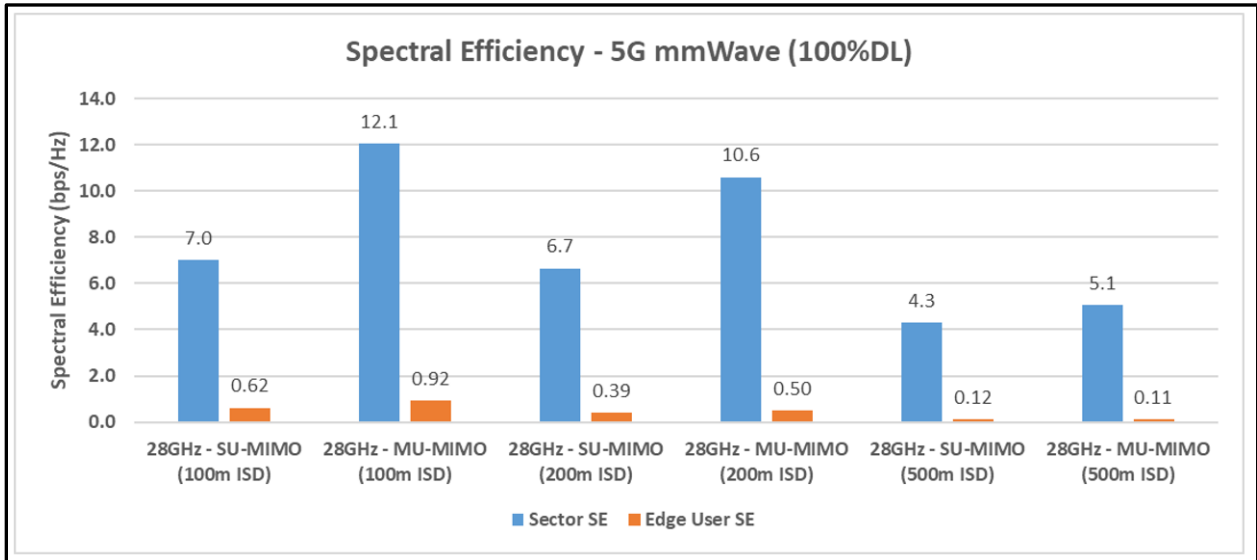

Figure 66 explains the parameters used for the spectral efficiency analysis shown in Figure 65.

**Figure 66: mmWave Spectral Efficiency Parameters**

Access Point:

- AP512: cross-pol array with 512 physical antenna elements (16,16,2), 256 elements per polarization
- Max EIRP = 63 dBm
- SU-MIMO vs MU-MIMO – beam-based transmission

UE:

- Dual-panel cross-pol array:
  - 2 panels oriented back-to-back with best-panel selection at UE.
  - Each panel is (4,4,2) with 32 physical elements per panel, 16 physical elements per polarization per panel, half wavelength spacing between rows and columns.
- Single TXRU per polarization -> 2 TXRUs

System:

- TDD, 200MHz bandwidth, full buffer traffic, 5 active UEs per sector
- UMa with various inter-site distances

**gNB: 2-TXRUs**

SU-MIMO

- 2 TXRUs at gNB
- 1 UE at a time
- 1 ≤ Rank ≤ 2

**gNB: 8-TXRUs**

MU-MIMO

- 8 TXRUs at gNB
- Up to 4 UEs at a time
- 1 ≤ Rank ≤ 2 per UE

**UE: 2-TXRU, 2-Panel w/selection**

Top View

2 panels back-to-back

Single panel (side view)

Over time, with improvements in the technology, spectral efficiency will increase.

5G performance in a live network will have large variation depending on deployment, traffic, environment, and other variables. Consequently, the spectral efficiency simulations

<sup>211</sup> Nokia contribution.

should be seen as examples of what can be achieved by the technology under specific assumptions rather than an indication of an actual spectral efficiency in any specific network deployment.

Figure 67 compares the uplink spectral efficiency of the different systems.

**Figure 67: Comparison of Uplink Spectral Efficiency<sup>212</sup>**

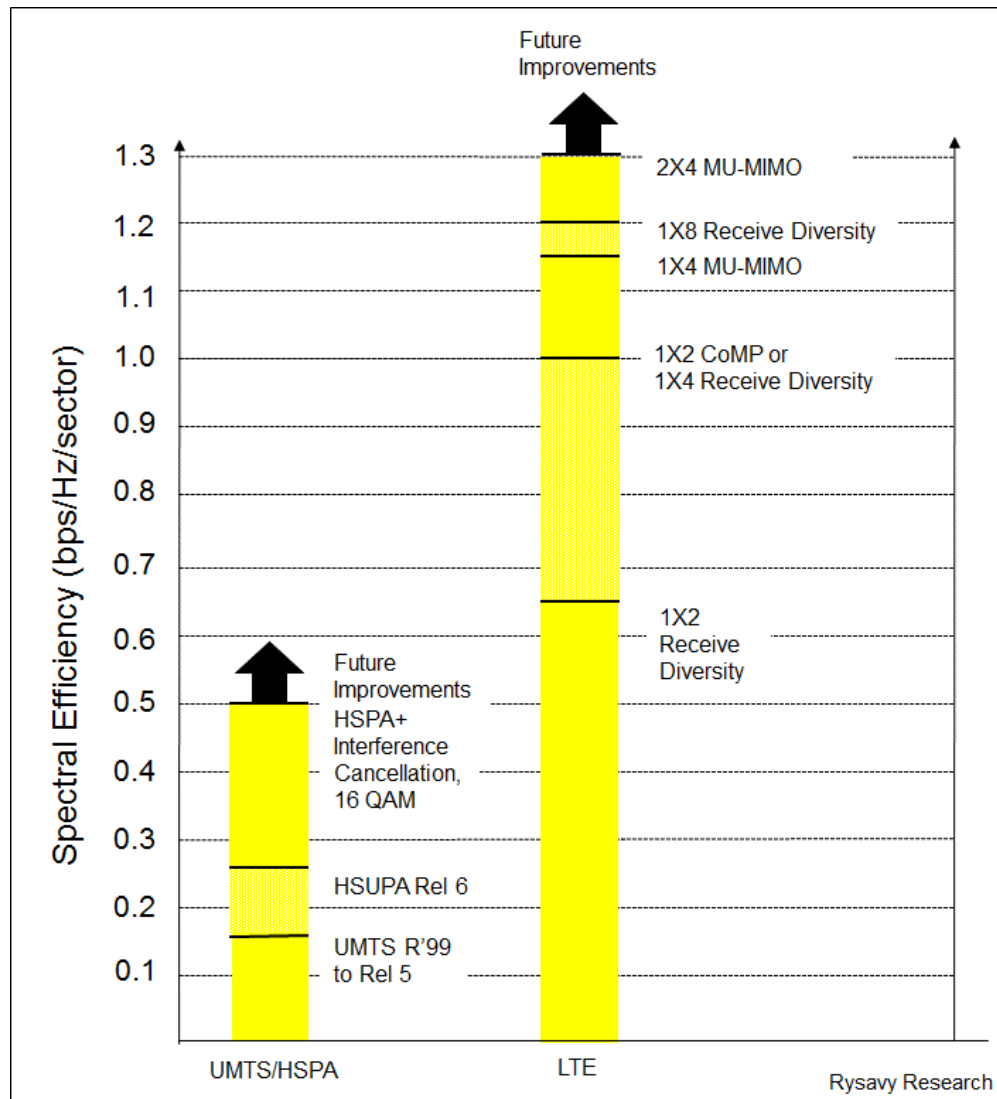

The implementation of HSUPA in HSPA significantly increases uplink capacity.

With LTE, spectral efficiency increases by use of receive diversity. Initial systems will employ 1X2 receive diversity (two antennas at the base station). 1X4 diversity will increase spectral efficiency by 50%, to 1.0 bps/Hz, and 1X8 diversity will provide a further 20% increase, from 1.0 bps/Hz to 1.2 bps/Hz.

<sup>212</sup> Joint analysis by 5G Americas members. 5+5 MHz for UMTS-HSPA/LTE. Mix of mobile and stationary users.

It is also possible to employ Multi-User MIMO (MU-MIMO), which allows simultaneous transmission by multiple users on the same physical uplink resource to increase spectral efficiency. MU-MIMO will provide a 15% to 20% spectral efficiency gain, with actual increases depending on how well link adaptation is implemented. The figure uses a conservative 15% gain, showing MU-MIMO with a 1X4 antenna configuration increasing spectral efficiency by 15%, to 1.15 bps/Hz, and 2X4 MU-MIMO a further 15%, to 1.3 bps/Hz.

In Release 11, uplink CoMP using 1X2 increases efficiency from .65 bps/Hz to 1.0 bps/Hz. Many of the techniques used to improve LTE spectral efficiency can also be applied to HSPA since they are independent of the radio interface.

Figure 68 compares voice spectral efficiency.

**Figure 68: Comparison of Voice Spectral Efficiency<sup>213</sup>**

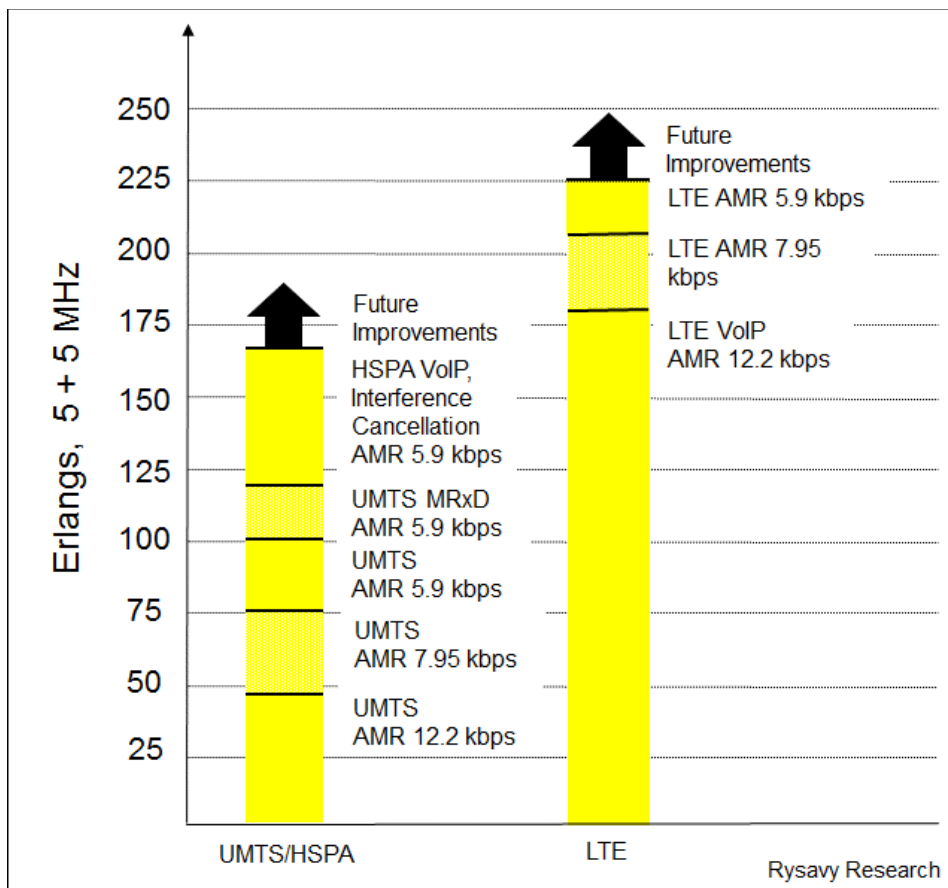

Figure 68 shows UMTS Release 99 with AMR 12.2 Kbps, 7.95 Kbps, and 5.9 Kbps vocoders. The AMR 12.2 Kbps vocoder provides superior voice quality in good (for example, static and indoor) channel conditions.

<sup>213</sup> Joint analysis by 5G Americas members. 5 + 5 MHz for UMTS-HSPA/LTE. Mix of mobile and stationary users.

UMTS has dynamic adaptation between vocoder rates, enabling enhanced voice quality compared with EVRC at the expense of capacity in situations that are not capacity limited. With the addition of mobile receive diversity, UMTS circuit-switched voice capacity could reach 120 Erlangs in 5+5 MHz.

VoIP Erlangs in this paper are defined as the average number of concurrent VoIP users that can be supported over a defined period of time (often one hour) assuming a Poisson arrival process and meeting a specified outage criterion (often less than 2% of the users exhibiting greater than 1% frame-error rate). Depending on the specific enhancements implemented, voice capacity could double over existing circuit-switched systems. These gains do not derive through use of VoIP, but rather from advances in radio techniques applied to the data channels. Many of these same advances may also be applied to current circuit-switched modes.

LTE achieves very high voice spectral efficiency because of better uplink performance since there is no in-cell interference. The figure shows LTE VoIP spectral efficiency using AMR at 12.2 Kbps, 7.95 Kbps, and 5.9 Kbps.

VoIP for LTE can use a variety of codecs. The figures show performance assuming specific codecs at representative bit rates. For Enhanced Variable Rate Codecs (EVRCs), the figure shows the average bit rate.

The voice efficiency of the wideband AMR voice codec, operating at 12.65 Kbps, is similar to the AMR codec at 12.2 Kbps, with a value of 180 Erlangs for both since both codecs operate at approximately the same bit rate. 1xRTT has voice capacity of 85 Erlangs in 5+5 MHz with EVRC-A and reaches voice capacity of 120 Erlangs with the use of Quasi-Linear Interference Cancellation (QLIC) and EVRC-B at 6 Kbps.

## **5G**

This section provides early details on aspects of 5G, including architecture, Dynamic Spectrum Sharing, integrated access and backhaul, and performance.

### **Architecture in Detail**

The overall 5G architecture consists of what 3GPP calls the New Generation Radio-Access Network (NG-RAN) and the 5G Core (5GC), as shown in Figure 69. The figure shows the Access and Mobility Management Function (AMF); the User Plane Function (UPF); the NR NodeB (gNB), which is the 5G base station; and the NG and Xn interfaces.

**Figure 69: 5G Architecture<sup>214</sup>**

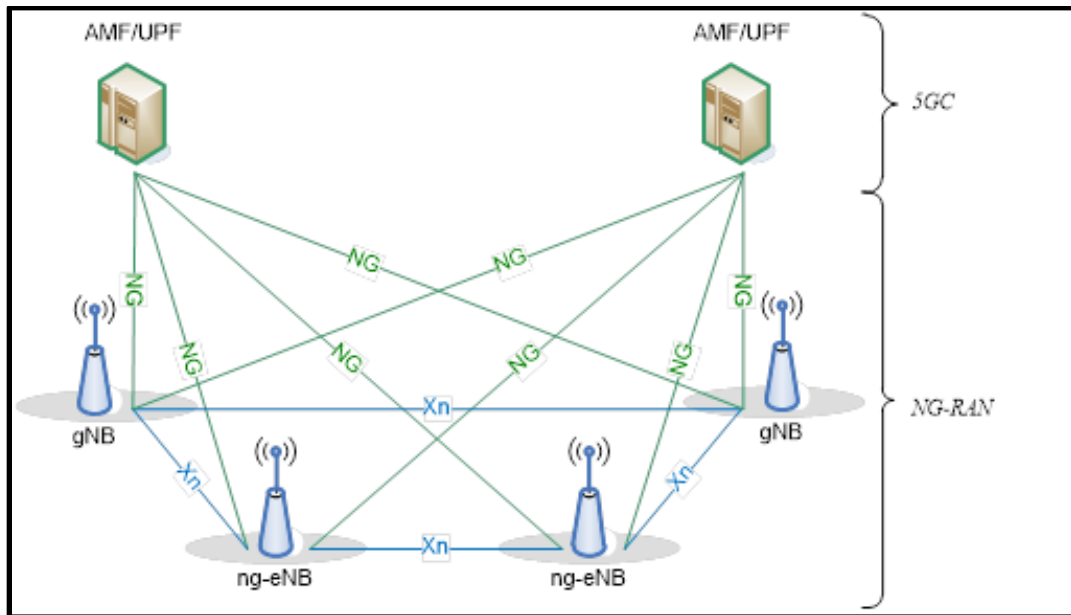
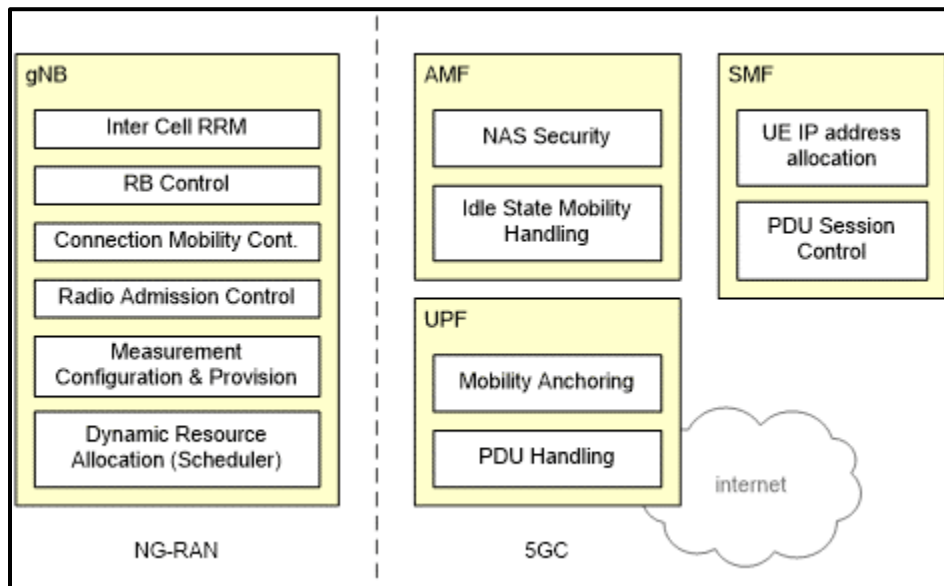

Figure 70 shows the functional split between the NG-RAN and 5GC.

**Figure 70: Functional Split between NG-RAN and 5GC<sup>215</sup>**



<sup>214</sup> 3GPP, 3GPP TS 38.300, NR; NR and NG-RAN Overall Description; Stage 2 (Release 15), V15.1.0 (2018-03).

<sup>215</sup> Ibid.

The main body of this paper summarizes the features being specified in Releases 15 and 16 for NR and the core network. Additional capabilities that will be part of Release 15 include:

- ❑ A PDCP packet duplication function to allow redundant transmission of signaling or user data on two bearer paths.
- ❑ A new protocol layer called Service Data Adaptation Protocol (SDAP) that offers 5GC QoS flows.
- ❑ A new Radio Resource Control (RRC) inactive state designed for low-latency communications.
- ❑ A new system information broadcast model that allows on-demand system information instead of always having to broadcast system information (to reduce overhead in 5G beam sweeping).

Figure 71 shows the 5G Service-Based Architecture (SBA), using HTTP-based APIs, which will provide the following benefits:<sup>216</sup>

- ❑ Every network function able to discover services offered by other network functions.
- ❑ Incorporation of principles such as modularity, reusability, and self-containment of network functions, enabling deployments to take advantage of virtualization and software technologies.
- ❑ Standalone operation without dependency on legacy networks.
- ❑ Flexible and extensible architecture.
- ❑ Support for network slicing.
- ❑ Easier integration with third-party software.
- ❑ Simultaneous access using the same data connection to local and centralized networks.

---

<sup>216</sup> For a more detailed discussion of the 5G system architecture, see 3GPP, "System architecture milestone of 5G Phase 1 is achieved," Dec. 21, 2017, [http://www.3gpp.org/NEWS-EVENTS/3GPP-NEWS/1930-SYS\\_ARCHITECTURE](http://www.3gpp.org/NEWS-EVENTS/3GPP-NEWS/1930-SYS_ARCHITECTURE).



**Figure 71: 5G Core Service Based Architecture<sup>217</sup>**

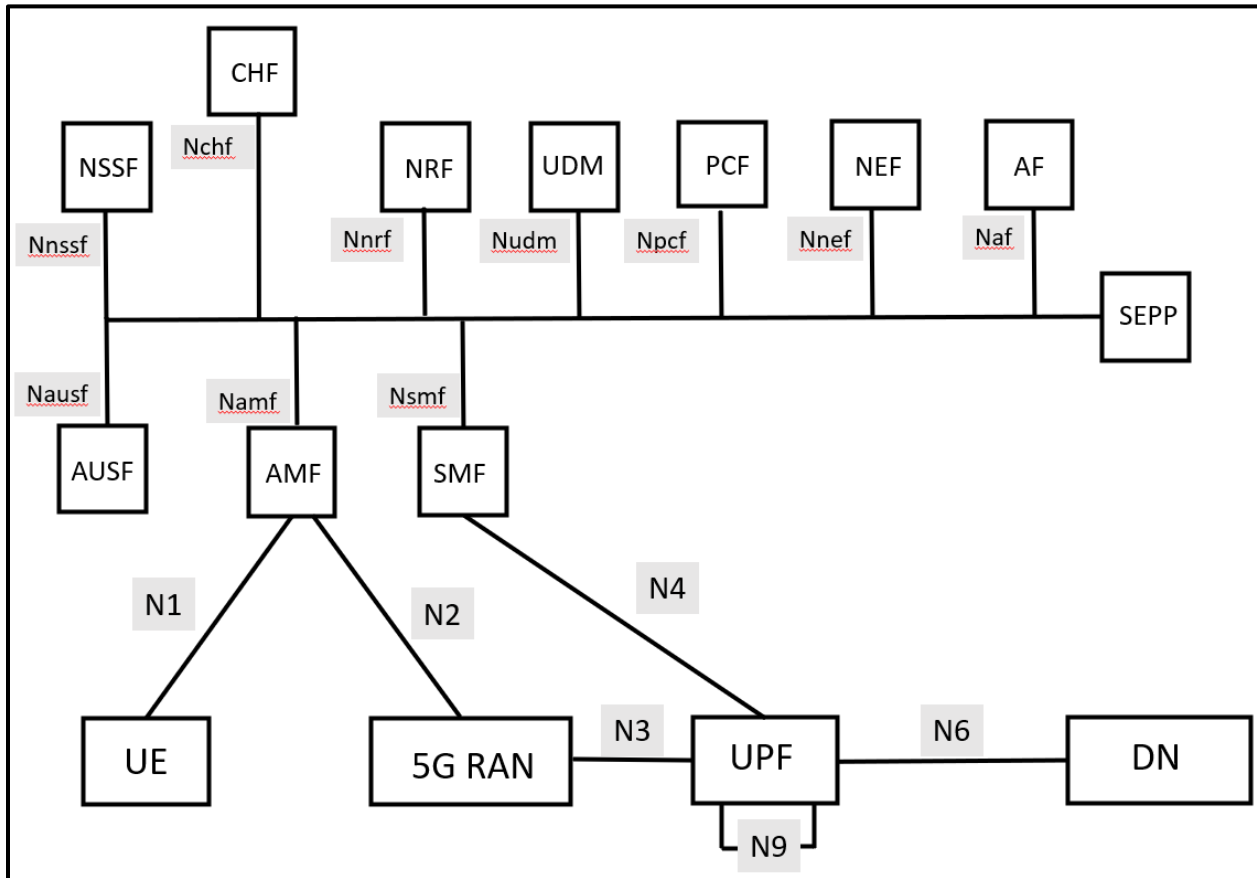

The functions performed by the nodes of the 5G network are as follows:

#### Application Function (AF)

- ❑ Fulfills the role of an application server to provide services.
- ❑ The AF can be either a trusted or untrusted function. It can also be within or outside the operator domain.

#### Authentication Server Function (AUSF)

- ❑ Contains the EAP authentication server functionality.
- ❑ Stores computer temporary keys and performs key distribution.

#### Core Access and Mobility Management Function (AMF)

- ❑ Termination point for RAN control plane (CP) interfaces.
- ❑ UE authentication and access security.

<sup>217</sup> 5G Americas, *5G Network Transformation*, Dec. 2017.  
[http://www.5gamericas.org/files/3815/1310/3919/5G\\_Network\\_Transformation\\_Final.pdf](http://www.5gamericas.org/files/3815/1310/3919/5G_Network_Transformation_Final.pdf).

- ❑ Mobility management.
- ❑ Session management.
- ❑ Network slice selection (expected).

#### Charging Function (CHF)

#### Network Exposure Function (NEF)

- ❑ Security for access to 5G core nodes.

#### Network Slice Selection Function (NSFF)

- ❑ Selects the set of Network Slice instances for the UE.

#### NF Repository Function (NRF)

- ❑ Provides Network Function (NF) profiles and supported services.
- ❑ Supports dynamic discovery of network functions.

#### Policy Control Function (PCF)

- ❑ Supports unified policy framework for network behavior.
- ❑ Corresponds for some functions to 4G Policy and Charging Rules Function (PCRF).
- ❑ Supplies some functions from 4G ANDSF.

#### Security Edge Protection Proxy (SEPP)

#### Session Management Function (SMF)

- ❑ Session management (non-access-related functions).
- ❑ Coordination of QoS policy.
- ❑ IP address allocation and management.
- ❑ Policy and charging functions.
- ❑ Policy enforcement.
- ❑ Lawful intercept.

#### Unified Data Management (UDM)

- ❑ Subscriber management database and related functions, similar to 4G Home Subscriber Server (HSS).

#### User Plane Function (UPF)

- ❑ Support for multiple configurations, including ones for low latency.
- ❑ Anchor point for intra/inter radio-access technology mobility.
- ❑ External IP interconnect point.
- ❑ Packet routing and forwarding.

- ❑ QoS handling for user plane.
- ❑ Lawful intercept.
- ❑ Roaming interface.
- ❑ Traffic counting and reporting.

Application Functions (AF)

- ❑ Operator trusted services.

**Architecture Options**

This topic was introduced in the main part of the paper and is covered here in more detail. In Release 15, 3GPP defines a number of different architecture options, shown in the following three figures. In many of these options, although not all, the 5G network integrates with LTE.

**Figure 72: 5G Network Architecture Options in 3GPP Release 15<sup>218</sup>**

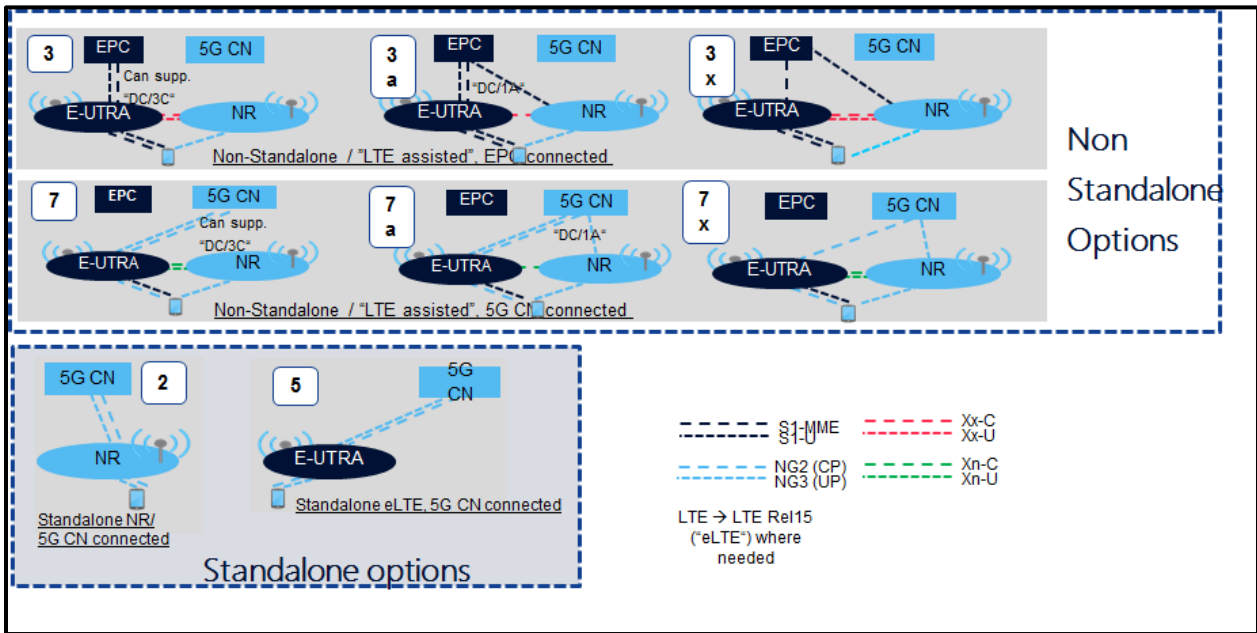

<sup>218</sup> Nokia contribution, including subsequent three figures. For further details, refer to section 7.2, "5G Architecture Options," 3GPP TR 38.801, "Radio access architecture and interfaces."

**Figure 73: De-Prioritized 5G Network Architecture Options in 3GPP Release 15<sup>219</sup>**

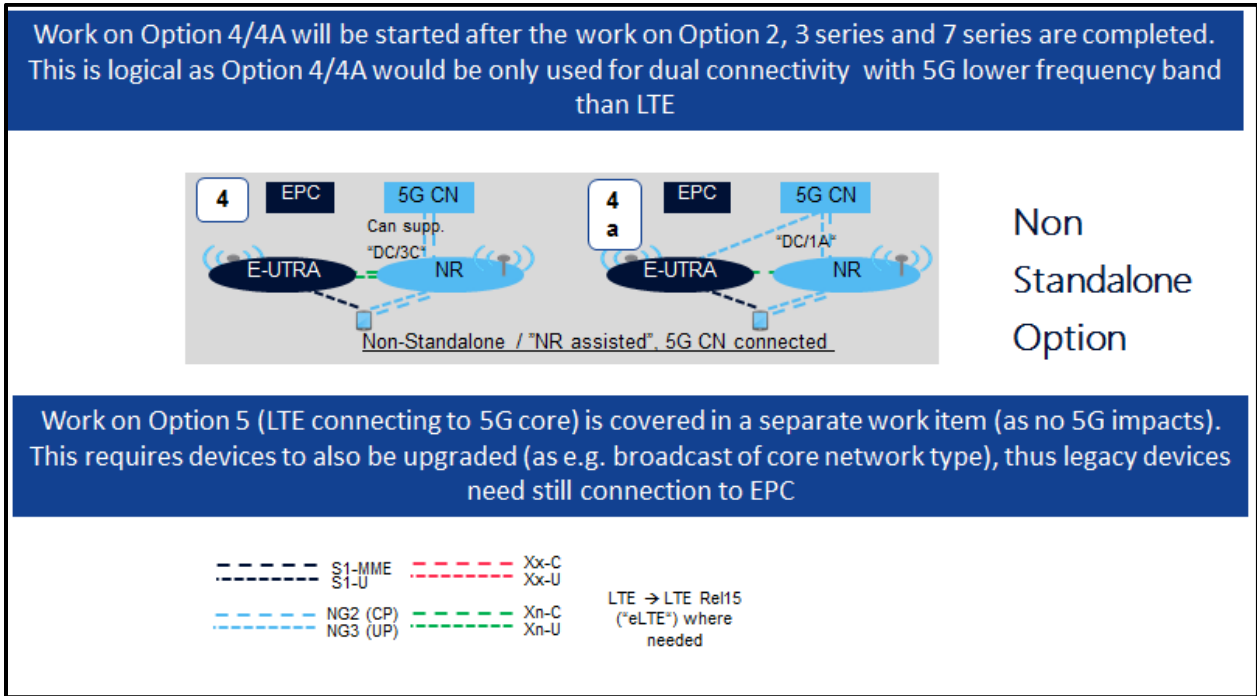
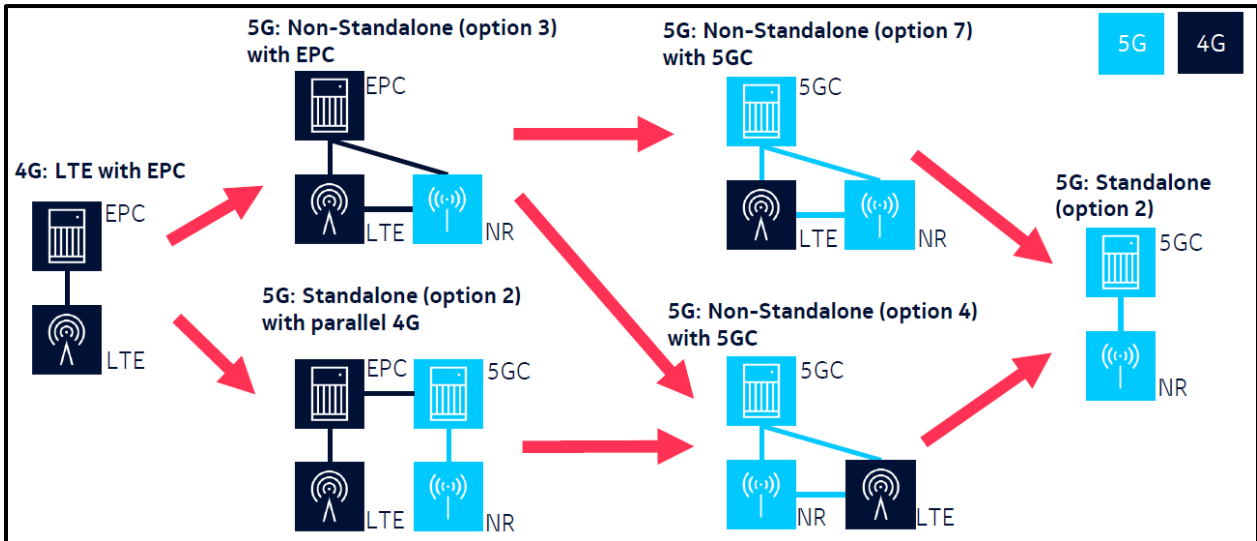

Figure 74 shows how these different architecture options provide operators flexibility as they migrate their networks from LTE to 5G.

**Figure 74: Different Migration Paths for LTE to 5G**



<sup>219</sup> Architecture options 4, 5, and 7 will be available in the final set of Release 15 specifications (ASN.1 freeze date) scheduled for Mar. 2019.

Figure 75 shows how 5G implements dual connectivity (simultaneous LTE and 5G connections) within the protocol stacks for some of the different architecture options.

**Figure 75: Dual-Connectivity Options with LTE as Master**

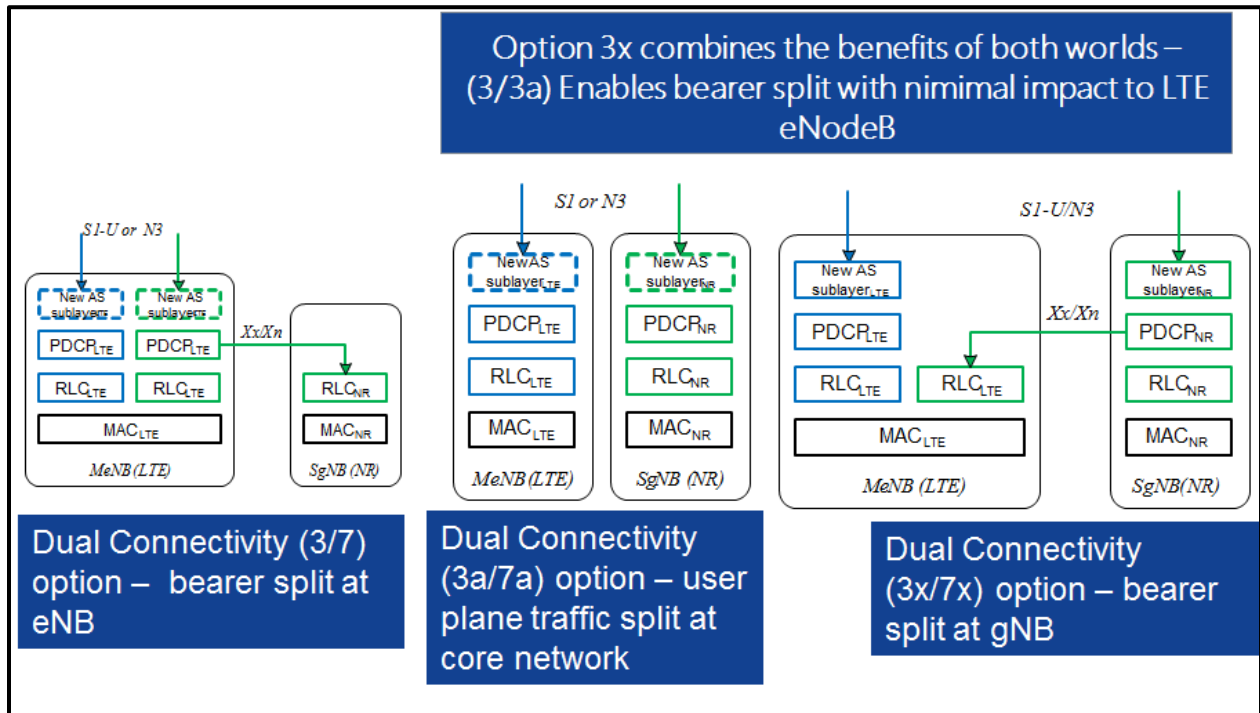

## C-V2X in Detail<sup>220</sup>

Refer to the section "Cellular V2X Communications" in the main part of this paper for an overview discussion.

Like LTE based V2X, the NR C-V2X allows direct communication mode (i.e. sidelink) between vehicles without relying on the cellular network connectivity.

NR C-V2X sidelink moves the default mode of operation from broadcast to reliable groupcast communication which is enabled by several fundamental new innovations. NR C-V2X sidelink is probably the first wireless system to introduce distance as a dimension at the physical layer. This enables achieving a uniform communication range across widely varying radio environments – for both line-of-sight and non-line-of-sight scenarios. Introducing distance as a dimension also enables formation of "on-the-fly" multicast groups based on distance and applications. Such multicast groups require little or no overhead for group formation and dismantling.

Besides the new Groupcast mode, NR C-V2X also introduced the "true" unicast mode on sidelink. The NR C-V2X sidelink unicast supports ACK/NACK based HARQ feedback, link quality monitoring (e.g. CSI reporting and Reference Signal Received Power [RSRP] reporting), higher modulation rate (e.g. 256 QAM), and rate controls. This feature enables

<sup>220</sup> This section on C-V2X is a 2020 Qualcomm contribution.

reliable interactive V2X sessions, and is crucial for some of the advanced use cases, e.g. maneuver coordination, or session-based communication with Road Side Units (RSUs).

A NR C-V2X UE can establish multiple simultaneous unicast sidelink connections with other UEs, based on application needs. These links are allowed to have different configurations, including the QoS levels, data rates, security protections, etc. Each of the link is independently managed and maintained. Multiple services can share the same link, and therefore, different QoS flows can be supported over the same link. NR C-V2X unicast sidelink supports both IP based or non-IP based traffic. This flexibility allows native support of various V2X services and deployment configurations. For example, when IP based transport is used, an RSU can further forward the messages from the C-V2X UE to a remote server.

The unicast sidelink can be established between NR C-V2X UEs on-demand, by transmitting either broadcast or unicast a connection request to a known UE or UEs supporting a desired V2X service. This unicast link establishment procedure had already incorporated security verifications. The 3GPP design provides a generic authentication mechanism and supports various application layer security associations, e.g. certificate-based security association that is widely used in V2X ecosystem. The unicast sidelink can provide confidentiality and integrity protection for the signaling and user data, based on security requirements of the application and policies. Additionally, the NR C-V2X design also provides privacy protection for the unicast sidelink, by allowing a change of the link identifiers during the communication session, without interrupting the service. This helps the UE to meet the regulatory requirements on anti-trackability in some regions. The unicast sidelink management details are available in 3GPP TS 23.287.

One of the major characteristics of NR, aka. 5G radio, is the enhanced Quality of Service (QoS), e.g. higher reliability and lower latency. Naturally, NR C-V2X sidelink design also provides significant QoS enhancements comparing to LTE V2X. From system aspect, NR C-V2X sidelink introduced a unified QoS model based on QoS Flow managements for all cast types, i.e. broadcast, groupcast, and unicast. V2X application traffic can be filtered using a QoS rule filter and placed into different QoS Flows. Each of the QoS Flows is configured with a PC5 5QI (PQI, or PC5 5G QoS Identifier) that represents the QoS characteristics, e.g. delay budget, priority, reliability, etc., and additional QoS flow parameters. For example, for groupcast, the QoS flow parameters further include the maximum Range value, which can be passed to a lower layer to perform the distance based groupcast control. For unicast, the QoS flow parameters include the link data rate, which helps the lower layer choose the coding and modulation mechanism.

This design provides much higher level of QoS control comparing to the simple priority based QoS in Release 14 LTE V2X. The QoS Flow based management also makes NR C-V2X sidelink QoS management more aligned with NR Uu model, and facilitates a consistent application management regardless of the link used. The new QoS level (PQIs) that can be achieved by NR C-V2X are documented in TS 23.287.

NR C-V2X employed a new PHY layer design to achieve the better QoS, e.g. higher reliability, higher throughput, and lower latencies, as well as the flexibility for forward compatible.

NR-V2X sidelink physical channels are transmitted using only CP-OFDM waveform, with subcarrier spacing of 15, 30, 60 and 120 kHz associated with CPs and frequency ranges similar to NR UL/DL, and with modulation schemes as QPSK, 16-QAM, 64-QAM, and 256-QAM.

The NR V2X sidelink uses the following physical channels and signals:

- ❑ Physical sidelink broadcast channel (PSBCH) and its DMRS
- ❑ Physical sidelink control channel (PSCCH) and its DMRS
- ❑ Physical sidelink shared channel (PSSCH) and its DMRS
- ❑ Physical sidelink feedback channel (PSFCH)
- ❑ Sidelink primary synchronization signal (S-PSS) and sidelink secondary synchronization signal (S-SSS) referred as the sidelink synchronization signal (SLSS), structured together with PSBCH into the sidelink synchronization signal block (S-SSB).
- ❑ Phase-tracking reference signal (PT-RS) in FR2.
- ❑ Channel state information reference signal (CSI-RS).

The resources for transmitting PSSCH can be determined through a sensing procedure conducted autonomously by the transmitting UE, i.e. resource allocation mode 2. This is the default operation mode and allows the UE to operate in or outside of 5G coverage. Especially for operation in ITS spectrum, which is not managed by any operator, this mode of operation will be utilized. In case the UE is in coverage of a 5G cell that is enhanced for V2X, a gNB can also help to schedule or configure the sidelink transmitting resources in the licensed spectrum.

A given Transport Block (TB) can be transmitted multiple times, with HARQ feedback (i.e. HARQ retransmission) or without HARQ feedback (i.e. blind retransmission). DMRS associated with rank-1 or rank-2 PSSCH can be transmitted in 2, 3, or 4 sidelink symbols distributed through a sidelink slot.

For better operation reliability, NR V2X enables UEs to obtain timing synchronization from a variety of sources, including GNSS, eNB/gNB and other UEs, enabling synchronization in-coverage and out-of-coverage. A UE may serve as a synchronization source by transmitting sidelink synchronization signal block (S-SSB) and may provide synchronization information to other UEs even if it does not participate in the subsequent inter-UE communication. The V2X synchronization procedure defines priorities among such synchronization sources and requires all UEs to continuously search to get to the highest-quality synchronization source they can find.

At network side, the 5G system design is also enhanced, in order to assist the NR C-V2X operation, in case the NR C-V2X UE is in coverage. For example, 5G system has enhanced its UE Policy provisioning feature, so that the Policy Control Function (PCF) is able to update the UE authorized for NR C-V2X operation of the V2X related policies and configurations (V2XP) via the control plane signaling, when the UE comes into coverage. It also allows the NR C-V2X UE to autonomously request a policy update from the PCF when necessary. This feature also allows an V2X Application Server to provision the V2X Service operation parameters, e.g. QoS mapping, or security requirements, via the PCF to the UE reliably.

The 5G system is also enhanced to provide some of the NR C-V2X operation configurations to the radio network (NG-RAN), to assist the UE operation. The NG-RAN may then provide the information, e.g. in the System Information Block (SIB), or using dedicated RRC signaling if UE goes into CONNECTED mode. This helps the UE to obtain the most up-to-date operation configuration, e.g. on how to map QoS Flow to sidelink radio bearers, in

case the spectrum is managed by the operators. For ITS spectrum, the UE can operate based on purely configuration.

The 5G Core Network (5GC) has also introduced some enhancements, to facilitate better V2N services when Uu connection is used. These includes the notification on QoS Sustainability Analytics, and the Alternative QoS Profiles. The notification on QoS Sustainability Analytics allows the 5GC to provide an estimation of the QoS level support along the path indicated by a V2X Application Server. The V2X Application Sever could adjust its QoS requirements if 5GC informs it ahead of time that some QoS level cannot be met. On the other hand, the Alternative QoS Profile allows the V2X Application Server to request multiple QoS levels to the 5GC. In case there is a congestion in the network, the NG-RAN will automatically adjust the QoS level to one of the provided Alternative QoS Profiles. This ensures that the mission critical V2X application can continue at the minimum operational level, instead of being cut off.

With the completion of Release 16, 5G NR C-V2X establishes a technology platform enabling inter-vehicle communication independent of the cellular network to support a rich set of features for human-driver and automated vehicles. Moving forward, 3GPP has initiated work on Release 17. Intended C-V2X enhancements are expected to include improved UE power saving to enable PC5 operation for battery-powered road users such as pedestrians and cyclists and extending PC5 to non-vehicular devices. In addition, sidelink relay to network and sidelink relay among UEs are further enhancements in Release 17.

### **NR-U in Detail<sup>221</sup>**

See the main part of this paper, "Unlicensed Spectrum Integration," for an overview of this topic. This appendix section explains NR-U in technical detail suitable for readers who already have a good understanding of 5G NR.

3GPP has been working on adapting LTE and NR to operate in unlicensed spectrum since around 2013. In unlicensed operation under LTE, the scope was for introducing a licensed assisted access (LAA) mode of operation using unlicensed band where the primary cell is in a licensed band. In Release 13, the first version of LAA was introduced with unlicensed carrier as supplemental downlink (DL) for the main use case of improving the DL throughput of a carrier aggregation (CA) operation. In Rel.14, uplink (UL) operation was added with Physical Uplink Shared Channel (PUSCH) and Sounding Reference signal (SRS) added, so that UL throughput under CA was improved as well. Rel ease 15 introduced further enhancements on the flexibility and efficiency of operation including Autonomous UL (AUL) to support UE contending for the channel and more flexible starting/ending positions for both DL and UL.

On channel access, because the LTE-LAA was targeting 5GHz band where Wi-Fi was already deployed, the channel access mechanism was designed not only to comply with regulatory requirements, but also not to degrade the performance of already deployed Wi-Fi systems. A coexistence evaluation campaign was conducted to determine the energy detection (ED) threshold to be used and how zealous the LTE-LAA transmission attempts could be in order to guarantee that LTE-LAA deployment were friendly neighbors to

---

<sup>221</sup> This section on NR-U is an edited version of a 2020 Qualcomm contribution. See also, Qualcomm, "3GPP commits to 5G NR in unlicensed spectrum in its next release," Dec. 13, 2018. <https://www.qualcomm.com/news/onq/2018/12/13/3gpp-commits-5g-nr-unlicensed-spectrum-its-next-release>.



existing Wi-Fi deployment, while providing fair channel access sharing between the two systems.

In Release 15 when NR was being standardized, a study on porting NR design to unlicensed band was conducted in parallel, and this effort eventually led to the first release of NR-unlicensed design in Release 16. In the Release 16 NR-U design, Release 15 NR design is the baseline, while channel access mechanism and various enhancements are introduced to support efficient operation in unlicensed bands. Many features introduced for LTE-LAA are also ported to Release 16 NR-U, but the scope of Release 16 NR-U is greatly expanded to cover more deployment scenarios including CA, dual-connectivity (DC) and standalone (SA), as captured in the work item description, repeated below.

- ❑ Scenario A: Carrier aggregation between licensed band NR (Primary Cell [PCell]) and NR-U (Secondary Cell [SCell]).
  - NR-U SCell may have both DL and UL, or DL-only.
  - In this scenario, NR PCell is connected to 5G-CN.
- ❑ Scenario B: Dual connectivity between licensed band LTE (PCell) and NR-U (Primary Secondary Cell [PSCell])
  - In this scenario, LTE PCell connected to EPC as higher priority than PCell connected to 5G-CN.
- ❑ Scenario C: Standalone NR-U
  - In this scenario, NR-U is connected to 5G-CN.
- ❑ Scenario D: A standalone NR cell in unlicensed band and UL in licensed band (single cell architecture).
  - In this scenario, NR-U is connected to 5G-CN.
- ❑ Scenario E: Dual connectivity between licensed band NR and NR-U.
  - In this scenario, PCell is connected to 5G-CN.

As a result, Release NR-U can be deployed with CA to licensed carriers to improve data rates with the assistance of licensed band as in LTE-LAA, and can also be deployed by operators without licensed spectrum or operators not tightly integrating the licensed and unlicensed carriers, to support more flexible business models.

Release 16 NR-U targets both 5 GHz and 6 GHz bands. For the 5GHz band, a similar coexistence evaluation campaign as in LTE-LAA has been conducted with observations that in most cases, the NR-U deployment will not degrade the performance of co-deployed Wi-Fi systems. For the 6GHz band, because both NR-U and Wi-Fi are new systems to be deployed in the band, there is no commonly agreed fairness criterion.

### **Overview of NR-Unlicensed Design**

In the development of Release 16 NR-U, the Release 15 NR was used as the baseline, with channel access mechanism defined and various enhancements introduced to support more efficient operation under unlicensed band requirements. This section discusses the following aspects:

- ❑ Channel access mechanism

- ❑ Waveform changes for operating in unlicensed band
- ❑ DRS transmission
- ❑ HARQ enhancements
- ❑ MAC enhancements
- ❑ Upper Layer enhancements

**Channel access**

Release 16 NR-U supports two channel access operation modes: dynamic channel access mode (corresponds to Load Based Equipment in ETSI EN 301 893<sup>222</sup>) and semi-static channel access mode (corresponds to Frame Based Equipment in ETSI EN 301 893).

For dynamic channel access mode, the following Listen Before Talk (LBT) mechanisms are defined:

- ❑ Cat 4 LBT with a contention window (Type 1)
- ❑ Cat 2 LBT with 25  $\mu$ s gap (Type 2A)
- ❑ Cat 2 LBT with 16  $\mu$ s gap (Type 2B)
- ❑ Cat 1 LBT with no more than 16  $\mu$ s gap without channel sensing (Type 2C)

A Cat 4 LBT is composed of a 16  $\mu$ s initial deferral followed by a countdown stage with a step of 9  $\mu$ s and the number of countdown depends on the channel access priority class of the traffic. The Cat 2 LBT with 25  $\mu$ s gap and 16  $\mu$ s gap are defined in Figure 76. The rules to use these LBT mechanisms are summarized in the following four tables. To summarize, both gNB and UE can acquire a Channel Occupancy Time (COT) with Cat 4 LBT, while a gNB or UE can share the COT acquired by the other node with Cat 2 or Cat 1 LBT under different conditions. The only exception is the transmission of discovery Reference Signal (RS), which includes the transmission of Synchronization Signal Blocks (SSBs) and other non-unicast control and data, where under some restriction, 25  $\mu$ s cat 2 LBT can be used to acquire the COT.

**Figure 76: Type 2A and Type 2B LBT for Dynamic Channel Access Mode**

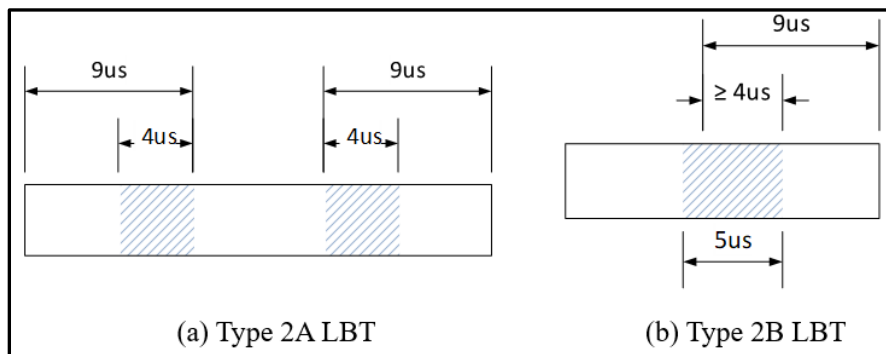

<sup>222</sup> ETSI, ETSI EN 301 893 "5 GHz RLAN; Harmonised Standard covering the essential requirements of article 3.2 of Directive 2014/53/EU."

**Table 17: Channel Access Mechanisms for gNB to Acquire a COT**

	Cat 2 LBT	Cat 4 LBT
<b>DRS alone or multiplexed with non-unicast data (e.g. OSI, paging, RAR)</b>	when the DRS duty cycle $\leq 1/20$ , and the total duration is up to 1 ms: 25 us Cat 2 LBT is used (as in LAA)	When DRS duty cycle is $> 1/20$ , or total duration $> 1$ ms  Any channel access priority class value can be used
<b>DRS multiplexed with unicast data</b>	N/A	Channel access priority class is selected according to the multiplexed data
<b>Physical Downlink Control Channel (PDCCH) and Physical Downlink Shared Channel (PDSCH)</b>	N/A	Channel access priority class is selected according to the multiplexed data

**Table 18. Channel Access Mechanisms for gNB for Additional DL Transmission in a gNB Acquired COT**

Cat 1 Immediate Transmission	Cat 2 LBT
When the gap from the end of the scheduled UL transmission to the beginning of the DL burst is up to 16 msec	When the gap from the end of the scheduled UL transmission to the beginning of the DL burst is larger than 16 msec but not more than 25 us

**Table 19. Channel Access Mechanisms for UE to Acquire a COT**

	Cat 4 LBT
<b>PUSCH (including at least UL-SCH with user plane data)</b>	Channel access priority class is selected according to the data
<b>UCI-only transmission on PUSCH</b>	Cat4 with lowest channel access priority class value
<b>SRS-only</b>	Cat4 with lowest channel access priority class value

Cat 4 LBT	
<b>RACH-only</b>	Cat4 with lowest channel access priority class value
<b>PUCCH-only</b>	Cat4 with lowest channel access priority class value

**Table 20. Channel Access Mechanisms for UE to Transmit in a gNB Acquired COT**

Cat 1 Immediate transmission	Cat 2 LBT
When the gap from the end of the DL transmission to the beginning of the UL burst is not more than 16 msec	For any of the following cases: <ul style="list-style-type: none"> <li>• When the gap between any two successive scheduled/granted transmissions in the COT is not greater than 25 msec</li> <li>• For the case where a UL transmission in the gNB initiated COT is not followed by a DL transmission in the same COT               <ul style="list-style-type: none"> <li>○ Note: the duration from the start of the first transmission within the channel occupancy until the end of the last transmission in the same channel occupancy shall not exceed 20 ms.</li> </ul> </li> </ul>

For semi-static channel access, in Release 16 NR-U, only gNB can contend for the channel as a fixed frame period boundary with period of 1ms, 2ms, 2.5ms, 4ms, 5ms, or 10ms. A fixed frame period contains an idle period at the end with length being at least 5% of the fixed frame period length or 100  $\mu$ s, whichever is longer.

**Figure 77. Fixed Frame Period Structure of Semi-Static Channel Access**

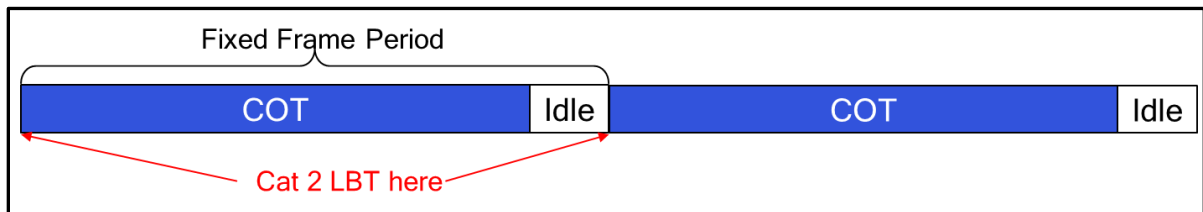

The channel access rules are summarized in Table 21. To summarize, only gNB can contend for the channel at the beginning of the fixed frame period, and a UE can share the gNB COT for transmission if gNB DL transmission is detected in the earlier part of the same COT.

**Table 21. Channel Access Mechanisms for gNB and UE in Semi-Static Channel Access Mode**

	Cat 1 LBT	Cat 2 LBT
<b>gNB to initiate COT</b>	N/A	At fixed location right before fixed frame period

<b>gNB transmit another DL burst in gNB COT</b>	If gap from previous DL/UL burst is within 16us	If gap from previous DL/UL burst is more than 16us
<b>UE to initiate COT</b>	N/A (UE cannot initiate COT in Rel.16 FBE)	
<b>UE to transmit UL burst in gNB COT</b>	If gap from previous DL/UL burst is within 16us	If gap from previous DL/UL burst is more than 16us

### Waveform changes

The waveform design for NR-U is subject to two set of requirements: The per MHz Power Spectral Density (PSD) limitation (10dBm/MHz) and the OCB requirement (the UE needs to occupy more than 80% of the bandwidth). To address these requirements, 3GPP introduced wider-band transmissions for the Physical Random Access Channel (PRACH), Physical Uplink Control Channel (PUCCH), and Physical Uplink Shared Channel (PUSCH).<sup>223</sup>

For PRACH, on top of the Release 15 NR of length 139 sequence for PRACH for 15KHz and 30KHz SCS, Release 16 NR-U also introduced length 571 sequence and length 1151 sequence for 30KHz and 15KHz Subcarrier Spacing (SCS) respectively. In this way, the transmission of PRACH occupied about 20MHz bandwidth and the transmission power can take full advantage of the 10dBm/MHz PSD limitation and 23dBm maximum transmit power to support relatively larger cell radius. On the other hand, the legacy length 139 sequence PRACH is still supported, and for smaller cells without uplink link budget issue, multiple frequency domain PRACH occasions can be supported within one 20MHz channel to support higher PRACH capacity.

**Figure 78. NR-U PRACH for 30KHz SCS**

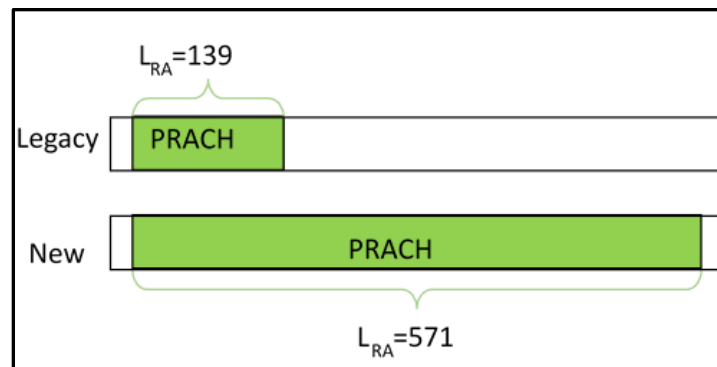

For PUCCH and PUSCH, Physical Resource Block (PRB) interlace structure is introduced to meet OCB requirement and boost transmit power under PSD limitation. For 30KHz SCS,  $M=5$  interlaces are defined. For 15KHz SCS,  $M=10$  interlaces are defined. Figure 78 below illustrates how interlaces are defined for 30KHz SCS. The interlaces are defined with respect to point A, and one interlace is formed by set of resource blocks (RB)  $M$  RBs apart.

<sup>223</sup> 3GPP, "NR; Physical channels and modulation", TS 38.211.

<https://portal.3gpp.org/desktopmodules/Specifications/SpecificationDetails.aspx?specificationId=3213>

**Figure 79. PRB Interlace Definition with 30KHz SCS**

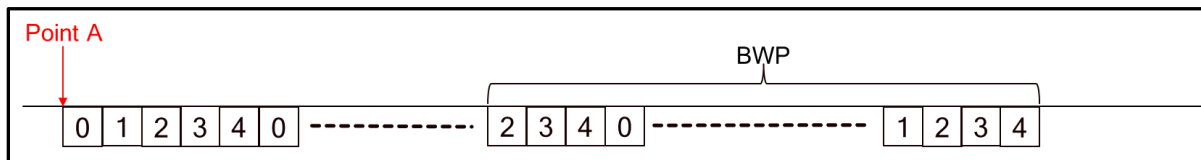

The concept of “RB set” is also introduced which approximately corresponds to one 20MHz channel. For PUSCH, the resource allocation is defined by continuous RB sets and the set of interlaces. Figure 80 shows an example with PUSCH allocated over one interlace across two RB sets in which the RBs in the assigned interlace over the two RB sets and the guard band between the assigned RB sets are allocated for PUSCH.

**Figure 80. Illustration of PUSCH Resource Allocation of One Interlace over Two Adjacent RB Sets**

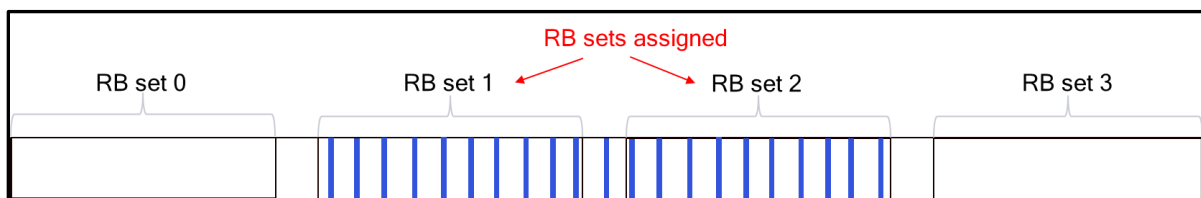

For PUCCH, Release 15 NR PUCCH format 0/1/2/3 are extended to PRB interlace waveform similar to PUSCH but constrained within one RB set. PUCCH format 0/1 in Release 15 is single RB only, and in Release 16, they are extended to one interlace with 10 or 11 RBs. PUCCH format 2/3 in Release 15 are already multiple RBs but in continuous RBs up to 16 RBs. In Release 16, they are extended to occupy one or two interlaces. If one interlace is used, frequency domain OCC and pre-Discrete Fourier Transform (DFT) Orthogonal Cover Code (OCC) are introduced for PUCCH format 2 and 3 respectively to improve the multiplexing capacity.

### DRS transmission

Discovery RS (DRS) is a concept introduced for NR-U to deliver critical information including PSS/SSS/PBCH blocks (SSB) and critical system information including System Information Block 1 (SIB1). In NR, for sub-7GHz bands, up to 8 SSBs can be transmitted every 20ms to support beam sweeping with different SSB positions. There is no quasi-colocation (QCL) relationship across up to 8 SSBs within one cycle, but SSBs at the same position in different cycles are assumed to be QCL'ed.

For unlicensed band operation, the gNB transmission are subject to LBT, so there is a chance that the SSBs cannot be transmitted due to LBT failure. There are two enhancements introduced to support a more reliable delivery of these critical system information:

- ❑ Cat 2 LBT can be used to start the DRS transmission if the duty cycle of the DRS is no larger than 1/20 and the length of the DRS is no longer than 1ms
- ❑ Expand up to 8 SSB positions in 20ms cycle (in Rel-15) to up to 20 candidate SSB positions every 20ms to allow more transmission opportunities

The first enhancement is introduced simply to allow higher chance for gNB to pass LBT by using Cat 2 LBT instead of a more stringent Cat 4 LBT, so DRS transmission has higher priority than other control/data transmission.

The second enhancement attempts to increase the chance for one SSB beam to be transmitted under possible LBT failures. In Figure 81, the concept is illustrated. Out of 20 candidate SSB positions for 30KHz SCS (up to 10 candidate positions for 15KHz SCS), the gNB will indicate a QCL relationship between the candidate positions such that every 1, 2, 4, or 8 candidate SSBs positions are QCL'ed. In the example in Figure 81, every 8'th candidate SSB positions are QCL'ed. The gNB can attempt channel access before each candidate SSB position, and if LBT passes, it can transmit SSB in the next up to 8 candidate SSB positions. For example, if LBT passes before candidate SSB position 0, gNB can transmit SSB in candidate SSB position 0 through 7. If LBT fails before candidate SSB position 0, but passes before candidate SSB position 10, the gNB can transmit SSB in candidate SSB position 10 through 17. No matter how the gNB starts transmission, the same candidate SSB positions across different cycle will be assumed to have the same QCL relationship.

**Figure 81. Illustration of SSB Transmission in NR-U**

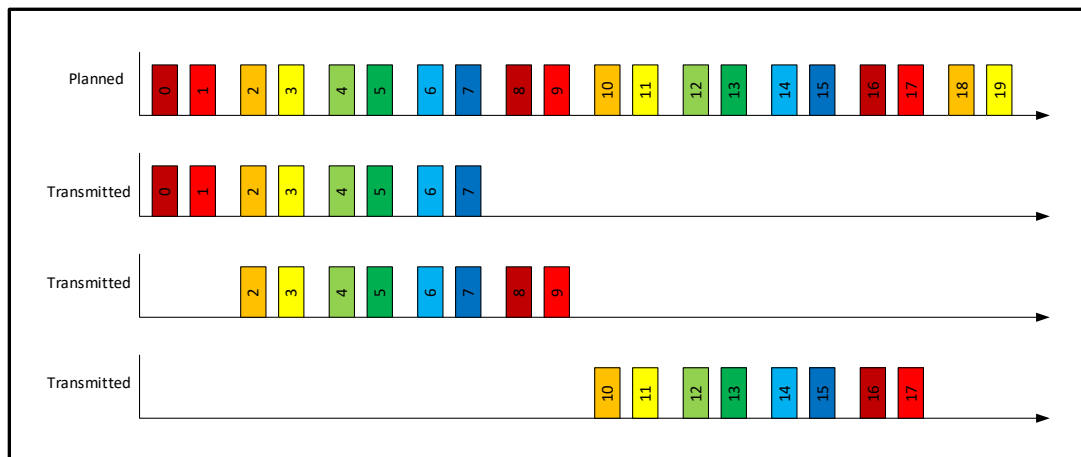

### HARQ enhancements

For operation in unlicensed band, a major issue with Hybrid Automatic Repeat Request (HARQ) operation is scheduled Acknowledgment/Negative Acknowledgment (ACK/NAK) transmission may not happen due to LBT failure. In Release 15 NR, there is no ACK/NAK transmission failure issue. If ACK/NAK is not received by the gNB, there is no mechanism to retransmit the ACK/NAK. This was acceptable for Release 15 because the probability for gNB failing to decode ACK/NAK is small and the gNB can schedule a retransmission of PDSCH to collect ACK/NAK. For unlicensed band operation, because the channel is shared with other nodes, the transmission of PUCCH or PUSCH carrying ACK/NAK is not guaranteed, and the probability that the UE failed ACK/NAK transmission cannot be ignored anymore. To solve this problem, three features have been designed:

- ❑ Non-numerical K1 indication for ACK/NAK transmission timing
- ❑ Enhanced dynamic codebook for HARQ ACK
- ❑ One-shot codebook for HARQ ACK

In Release 15 NR, in a DL grant, the UL ACK/NAK transmission timing is explicitly indicated as K1, relative to the PDSCH transmission time. In Release 16 NR-U, a non-numerical K1 feature is introduced, such that the gNB does not provide a time to report ACK/NAK when scheduling the Physical Downlink Shared Channel (PDSCH). Instead a special non-numerical K1 is indicated in the DL grant scheduling the PDSCH. The UE will hold on to the ACK/NAK corresponds to the PDSCH, and report ACK/NAK when a later PDSCH is scheduled with another DL grant with proper K1 timing indicated. This feature is especially useful for the case that the gNB DL transmission is close to the end of the gNB acquired COT and if the UE ACK/NAK transmission is using a UE acquired COT with Cat 4 LBT, the probability of transmission may not be guaranteed. So there can be benefit if the gNB asks the UE to hold on to the ACK/NAK transmission and trigger the transmission later when gNB acquires the COT again. The idea is illustrated in Figure 82.

**Figure 82. Illustration of the Usage of Non-Numerical K1 for A/N Scheduling**



The other two HARQ enhancement features are introduced to support UE ACK/NAK re-transmissions. For enhanced dynamic codebook design, HARQ ACK group concept is introduced. Within an HARQ ACK group, the already scheduled ACK/NAK (transmitted or failed to transmit) can be triggered to be retransmitted. Figure 83 shows an example on how the enhanced dynamic codebook works within one group. For the first PUCCH transmission, gNB schedules the UE to report HARQ ACK for 3 PDSCH, but the LBT failed for PUCCH transmission. In the next PUCCH occasion, gNB keeps sending PDSCH with DL grant with the same NFI (new feedback indicator). Thus the UE will retransmit the HARQ ACK already transmitted for the group, together with new HARQ ACK, corresponding to the new PDSCH and the PUCCH, containing 7 HARQ ACK bits. This time the LBT passes and the transmission is successful. In the next DL grant, the gNB will flip the NFI bit to indicate to the UE the HARQ ACK for the group is already received and no need to be included in the next PUCCH. Two groups of HARQ ACK can be defined and gNB can also trigger the transmission of HARQ ACK for both groups.

**Figure 83. Illustration of the Usage of Enhanced Dynamic Codebook**

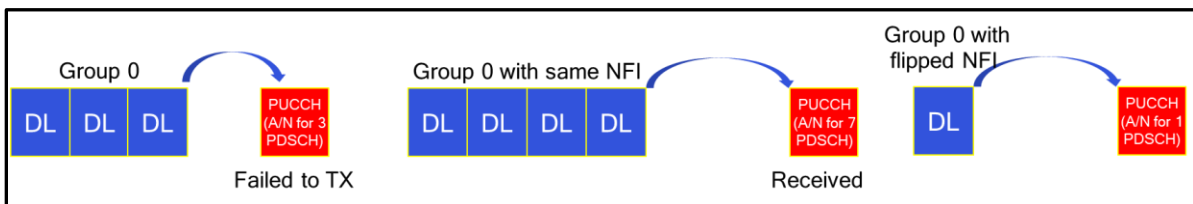

Additionally, Release 16 NR-U also defines a type-3 HARQ ACK codebook (one-shot HARQ ACK feedback). In this codebook design, gNB can trigger the report of ACK/NAK for all configured HARQ processes over all cells by setting a bit in a DL grant. This operation is illustrated in Figure 84.



**Figure 84. Illustration of the usage of one-shot HARQ ACK reporting**

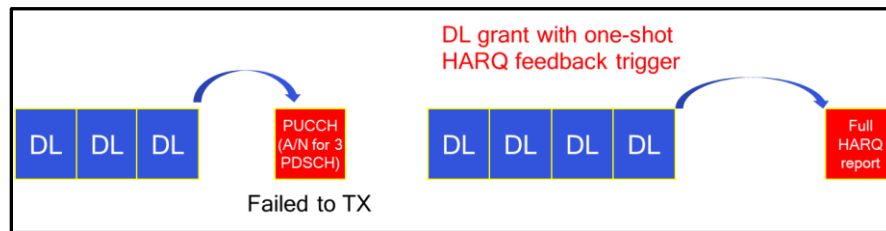

### MAC enhancements

- ❑ At the Medium Access Control (MAC) layer, several features were introduced to alleviate the impact of LBT mechanism on MAC procedures. The main ones are:
  - ❑ Consistent LBT failure detection and recovery
  - ❑ Changes to RACH procedures
  - ❑ Configured Grant (CG) changes

If LBT failures occur consistently on the uplink, it is beneficial to stop further transmission attempts on this cell and take further action e.g. by changing the cell. To this end, a new mechanism to detect and recover from consistent UL LBT failures was introduced. The mechanism is similar to the beam failure detection (BFD) and recovery where the detection is per Bandwidth Part (BWP) and based on all uplink transmissions within this BWP.

Similar to BFD, a timer is re-started with every LBT failure indication from physical layer to MAC; a counter is incremented with every LBT failure and is reset when the timer expires. When the counter exceeds a configured threshold, consistent UL LBT failure is declared on this BWP.

For failures on Secondary Cells (SCells), the UE reports this to the corresponding gNB (Master Node [MN] for Master Cell Group [MCG], Secondary Node [SN] for Secondary Cell group [SCG]) via a MAC Control Element [CE]. For SpCell (Primary [PCell] or Primary Secondary Cell [PSCell]), when consistent uplink LBT failures are detected, the UE switches to another UL BWP with configured RACH resources on that cell, initiates RACH, and reports the failure via MAC CE. If failures happen on all such BWPs, SCG failure for PSCell and RLF for PCell is declared.

During RACH procedure, LBT may fail for any of the RACH messages. The changes were aimed at guaranteeing that the procedure still works for both 4-step RACH and 2-step RACH.

If msg1 in 4-step RACH or msgA in 2-step RACH is not transmitted due to LBT failure, the UE does not increment the power of the next attempt. If the UE is configured with the above LBT detection/recovery, it also does not increment the transmission counter; in this case, the failure of RACH is handled by the LBT detection/recovery.

The LBT failure for transmission of msg2 in 4-step RACH or msgB in 2-step RACH necessitated longer monitoring windows at the UE to receive these messages. The maximum window duration was increased from 10ms in Release 15 to 40ms. However, this change caused possible ambiguity of determining the correct initial transmission for which the response was intended. To solve this, the gNB signals a 2-bit timing information for msg1 or msgA in the corresponding response message.

The changes to configured grant transmission are mainly due to autonomous retransmission on Configured Grant (CG) resources, autonomous HARQ process ID and Redundancy Version (RV) selection, and LBT failures. A new CG retransmission timer was introduced where the UE is allowed to retransmit a packet on a CG after this timer expires without any ACK from the gNB for the earlier transmission. The UE always prioritizes ongoing retransmissions over new transmissions. Since the UE signals HARQ ID and RV on CG transmissions, their selection is left to the UE implementation. NR-U also allows multiple CGs on a BWP where all of them use the above retransmission feature and can also share the same HARQ ID pool.

There were also relatively minor changes to other MAC procedures. For uplink multi-TTI transmission, the UE is allowed to select a HARQ process and RV to transmit a generated packet to handle the scenario when the LBT fails for the initial TTI occasions. To support transmission of DL HARQ feedback during Discontinuous Reception (DRX) operation, if the UE receives a non-numerical K1 (described in Section 3.4) where the actual Downlink Control Information (DCI) for HARQ feedback will be coming later, monitoring of downlink control channel was extended in time.

### **Upper layer enhancements**

For Connected Mode mobility, the only change for NR-U is the support of RSSI and Channel Occupancy (CO) measurements similar to LTE-LAA. These can be reported periodically or along with other measurement reports.

For Idle/Inactive mode mobility, the rules for checking other cells for reselection were relaxed to handle the cases when best cell on a frequency belongs to a different PLMN. This is a possible scenario in NR-U since multiple operators can share the same spectrum without any coordination as long as they meet the channel access rules. To further help the UE consider only the cells of the home or equivalent PLMN in reselection, a "white-list" of such neighbor cells is broadcasted.

In Release 15 NR, the UE has a single Paging Occasion (PO) for every DRX cycle in Idle/Inactive mode. Since LBT may fail during a paging transmission attempt, multiple PDCCH monitoring occasions were introduced for NR-U. This allows the gNB to transmit the paging message when LBT is not successful at the first instance. As monitoring of multiple occasions increases UE power, gNB can let the UE stop further monitoring when there is no page for that UE by transmitting a Short Message on paging channel with a newly introduced bit for this purpose. The UE can also stop monitoring when it detects a paging for other UEs with the assumption that the gNB had access to the channel and thus there is no page for itself.

Similar to LTE-LAA, Channel Access Priority Class (CAPC) can be configured for each data radio bearer (DRB). The signaling bearers (except for SRB2) always use the highest priority CAPC. The gNB assigns the CAPC by taking into account the specified mapping between 5QI (QoS indicator) of QoS flows in a DRB. The UE uses this configuration to determine the CAPC when not signaled by the gNB directly. This applies to all CG transmissions and some dynamic grants, where the UE selects the lowest priority CAPC among the multiplexed data flows. The exception is when signaling data is transmitted in which case the CAPC of the packet is same as the CAPC of the highest priority signaling bearer.

Release 16 NR-U also supports access restrictions, policing, and charging for all supported deployment scenarios. For example, a network can enforce access restrictions for shared spectrum during registration procedure or as part of mobility restrictions based on the

UE's subscription or other policies. In addition, charging for data usage on shared spectrum for both as primary or secondary RAT (MN or SN) is supported.

## **5G NR Cellular Positioning in Detail<sup>224</sup>**

For an overview, refer to the section in the main part of this paper, "5G NR Cellular Positioning." This appendix section explains NR positioning in technical detail suitable for readers who already have a good understanding of 5G NR.

Location technologies continue to ask for increasingly stringent requirements on accuracy, latency, efficiency and availability. In many scenarios, achieving such targets, especially with regards to accuracy, would require a combination of multiple technologies, including: GNSS based solutions, radio-technologies (e.g. LTE networks, Wi-Fi networks, terrestrial beacon systems, etc.), Inertial Measurement Units (IMU) or sensors. All these technologies are expected to play a significant role in achieving the location requirements in the future.

Inside the location technology ecosystem, the 3GPP NR radio-technology is uniquely positioned to provide significant value in terms of reaching the location requirements due to its operation in both low and high frequency bands (i.e. FR1 and FR2), the utilization of massive antenna arrays which provide additional degrees of freedom and the large bandwidths (e.g., 100 MHz in FR1 and 400 MHz in FR2). The possibility to use wide signal bandwidth in low and especially in high frequency bands brings new performance bounds for user location for well-known positioning techniques based on OTDOA, UTDOA, E-Cell-ID etc., utilizing timing measurements to locate a UE, but also new technologies introduced in the NR framework (e.g., Multi-RTT, AoD, AoA). The advances in massive MIMO open up additional degrees of freedom for accurate user location by exploiting spatial and angular domains of propagation channels in combination with time measurements that were used in previous cellular technologies.

The NR positioning technologies supported in 5G NR Rel-16 can be categorized in 3 main items: DL-only, UL-only and DL+UL positioning methods:

Downlink (DL) based positioning:

- DL Time Difference of Arrival (DL-TDOA)
- DL Angle of Departure (DL-AoD)

Uplink (UL) based positioning:

- UL Time Difference of Arrival (UL-TDOA)
- UL Angle of Arrival (UL-AoA)
- Combined DL and UL based positioning:
  - Round-trip time (RTT) with one or more neighbouring base station (multi-RTT)

In addition, Enhanced Cell-ID (E-CID) is supported based on radio resource management (RRM) measurements. The various NR positioning methods may be supported in one or more of the following positioning modes:

---

<sup>224</sup> This section on positioning is a 2020 Qualcomm contribution.

- ❑ **UE assisted mode:** the UE reports position measurements, and the location server performs the computation of a location estimate. The network may provide assistance data to the UE to enable position measurements.
- ❑ **UE based mode:** the UE performs both position measurements and computation of a location estimate and assistance data for one or both of these functions is provided to the UE.
- ❑ **Network based mode:** A location server derives location measurements using signals transmitted by a UE and computes a location estimate. The transmission of the UE's signals may or may not be transparent to the UE.

### Downlink Time Difference of Arrival (DL-TDOA) Positioning

This method is based on Time of Arrival (TOA) measurements of DL signals, DL Positioning Reference Signals (DL PRS) described in detail in Section 5.1, which are transmitted from multiple Time Relative Positionings (TRPs). Using the TOA measurements at the UE, Time Difference of Arrival (TDOA) measurements are calculated using a common TOA reference (which can be the estimated TOA associated with a specific TRP, or even with a specific beam of a TRP). The calculated TDOAs are referred to as DL Reference Signal Time Difference (DL-RSTD) measurements. The principle of NR DL-TDOA is similar to corresponding methods from previous generations of cellular systems, e.g., Observed Time Difference of Arrival (OTDOA) in LTE and UMTS, Advanced Forward Link Trilateration (AFLT) in CDMA, or Enhanced Observed Time Difference (E-OTD) in GSM.

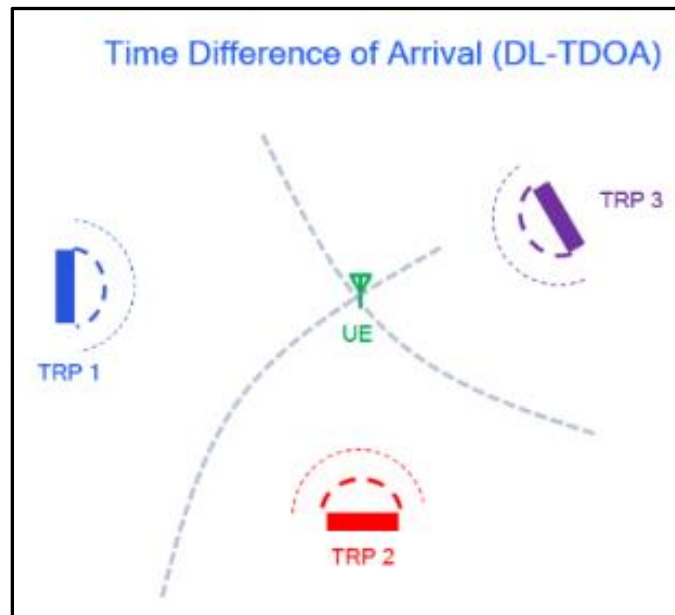

To assist the UE in performing the DL-RSTD measurements, the UE receives assistance data from a Location Server (LMF). The assistance data may be delivered in a dedicated (UE-specific) manner or a broadcast manner (See Section 6.2). The DL-TDOA assistance data contains a list of candidate TRPs together with their DL-PRS signal configurations. Multiple DL-PRS resources can be configured to be transmitted from each candidate TRP. For example, each PRS resource may correspond to a different transmit beam of the TRP, a feature that is especially useful for mid/high-band scenarios in FR1 and mmW deployments. The UE then tries to detect the DL-PRS from each candidate TRP and measures the TOAs from which the TDOAs are calculated.

- ❑ In case of UE-assisted mode, the UE provides the measurements to the location server
- ❑ In case of UE-based mode, the location assistance data include the geographical locations of the candidate TRPs and the Real Time Differences (RTDs). With this information, the UE is able to calculate the location (possibly using other location measurements available at the UE in case of "hybrid location") and may provide the location estimate to the server.

### Downlink Angle-of-Departure (DL-AoD) Positioning

Downlink Angle-of-Departure (AoD) positioning is based on per-beam RSRP measurements of DL-PRS performed at the UE (DL-PRS Reference Signal Received Power (DL-PRS RSRP) measurement). In this method, the TRPs transmit beamformed DL-PRS in a beam sweeping manner that may be measured by the UE. A UE may report up to 8 RSRP measurements, derived on different DL-PRS resources, or in other words, derived on different Tx beams of the same TRP. The UE RSRP measurement vector can be considered as a "RF fingerprint" and AoD calculation may be performed using a pattern matching approach. By comparing the measured DL-PRS RSRP vector to the fingerprints of all pre-stored angles, a e.g. maximum likelihood algorithm can be used to estimate the Azimuth Angle of Departure (AOD) and Zenith Angle of Departure (ZOD). As with any pattern matching approach, a data base of reference "fingerprints" must be available, which in this case, requires the beam spatial information.

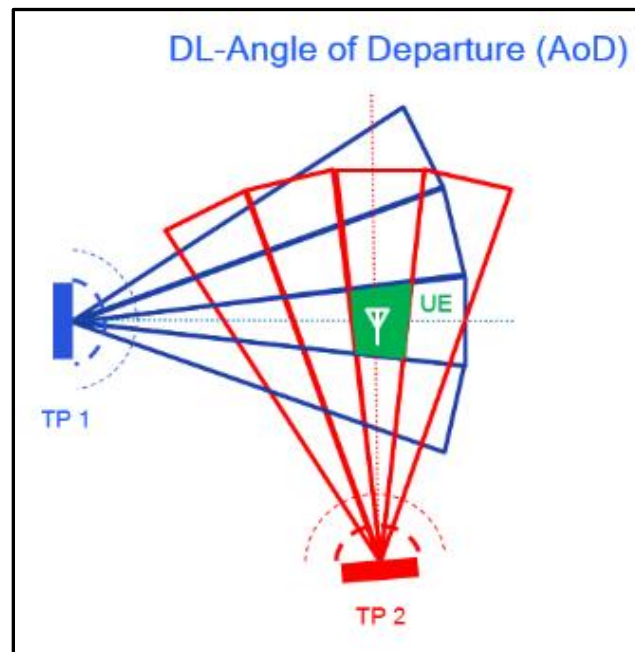

Similar to DL-TDOA, the UE requires assistance data for performing the measurements, including a list of candidate TRPs together with the DL-PRS signal configuration. In FR2, an additional feedback from the UE is supported, which can be used to inform whether 2 or more RSRP measurements were derived using a fixed RX beam. Such an additional reporting is needed for DL-AoD method because the UE may have to perform other operations for normal communication in parallel to positioning measurements, and therefore it may not always be possible to use a fixed/same RX beam for the DL-PRS RSRP measurements. If the UE is not using the same Rx beam when receiving multiple PRS resources of the same TRP, then the RSRPs measurements are not only representative of

the DL Beam sweeping and the RF pattern of the gNB, but they are affected by the UE-chosen Rx beam.

For UE-based mode, the UE requires additional assistance data including the TRP geographic locations (similar to DL-TDOA) and the DL-PRS beam information (e.g., beam azimuth, elevation). However, TRP synchronization information (e.g., RTDs) are not required for DL-AoD positioning, because DL-AoD also be deployed in loosely synchronized networks.

### **Uplink Time Difference of Arrival (UL-TDOA) Positioning**

The UL Time Difference of Arrival (UL-TDOA) is in principle the uplink/downlink dual of the DL-TDOA method: The UE transmits an UL signal (in NR Rel-16, this corresponds to the SRS for Positioning described in Section 4.2), which is received by multiple TRPs (serving and neighboring TRPs), each one determining their corresponding TOA. The estimated TOAs, which are measured and reported with respect to a relative common time scale, are referred to as UL Relative Time of Arrival (RTOAs). Similar to DL-TDOA, where the DL transmission of different TRPs must be synchronized, the UL reception points for UL-TDOA must also be synchronized.

In order to obtain the uplink measurements, the TRPs need to know the transmission properties (bandwidth, symbols, scrambling sequence) of the SRS signals transmitted by the UE for the time period required to calculate uplink RTOA measurements. The TRPs receive this information from the location server, such that the TRPs are able to measure the SRS and derive the RTOA measurements.

The RTOA measurements of all participating TRPs are sent to the LMF, which calculates TDOAs; a procedure that cancels the unknown transmit time of the UE. Then, similar to DL-TDOA, position calculation can be based on hyperbolic trilateration.

UL-TDOA is a network-based positioning method, where the positioning operation can be transparent to the UE, especially for the case of UEs transmitting Rel-15 uplink signals (NR Rel-15 SRS and not the NR Rel-16 SRS for Positioning); The UE is only required to transmit the UL signal, but does not perform any positioning measurements.

### **Uplink Angle-of-Arrival (UL-AoA) Positioning**

Uplink Angle-of-Arrival (AoA) positioning is another network-based positioning method (similar to UL-TDOA), in which a TRP (either serving or neighbouring TRP) uses the received signal transmitted by the UE to derive the angle of arrival (AOA) in azimuth and zenith. Similar to UL-TDOA, if the UL signal is defined for communication purposes (NR Rel-15 Sounding Reference Signals), the UL-AoA positioning can be transparent to the UE. In NR Rel-16 however, the SRS for positioning was designed for all UL measurements related to positioning and can be reused for UL-AoA, UL-TDOA and M-RTT positioning (Section 3.5).

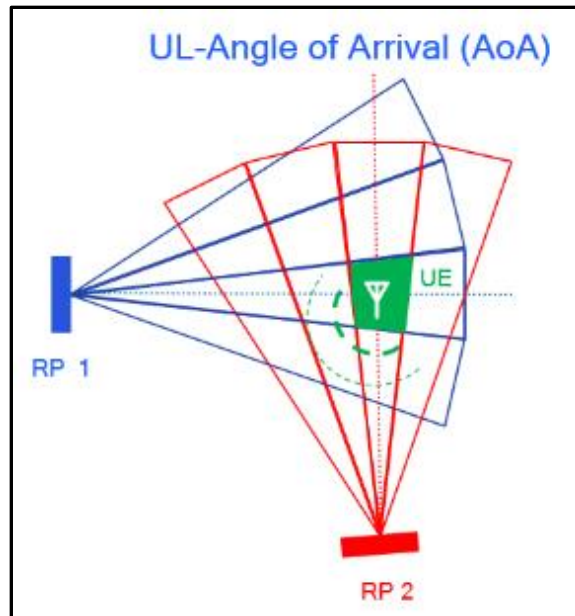

Estimating the angle of arrival requires directional antennas at the TRPs, which are already readily available at the NR gNBs in both FR1 and FR2 (e.g., in Massive MIMO deployments). A straightforward way to estimate the AoA is to perform receive beam steering; electronically steer beams in a set of fixed directions and look for peaks in the output power. Such approaches typically may have limited angular resolution. Another way is to perform digital beam steering, or use subspace-based methods, e.g., multiple signal classification (MUSIC) algorithm, or estimation of signal parameters through rotational invariance technique (ESPRIT). These AoA estimation techniques require digital samples of each antenna element output.

The procedures for UL-AoA positioning are similar to UL-TDOA: The UE is triggered by the network to transmit an UL signal and selected TRPs in the neighborhood of the UE are configured by an LMF via NRPPa to listen to the UE transmission and measure the UL AoA. However, compared to UL-TDOA no common time reference is needed at the TRPs, and therefore, UL-AoA positioning is also suitable for loosely synchronized networks.

### **Multi-Round-Trip-Time (Multi-RTT) Positioning**

With regards to timing methods supported in cellular technologies, both DL-TDOA and UL-TDOA positioning require installing and maintaining hardware for very precise base station time synchronization. Loosening these time synchronization requirements was one of the reasons that NR Rel-16 introduced the Multi-cell RTT positioning method.

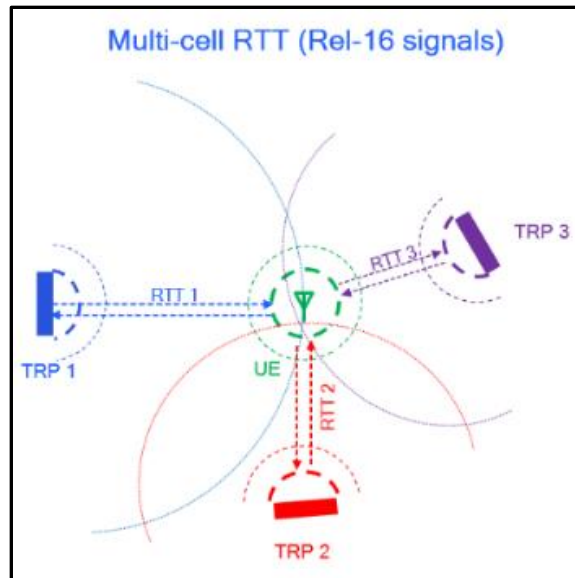

Specifically, Round-Trip-Time (RTT) positioning uses two-way time-of-arrival measurements and requires in principle no time synchronization between TRPs, even though in the reality some loose synchronization might be desired in order to reduce interference and increase hearability from multiple transmission points. This time synchronization requirement is similar to the TDD synchronization requirements (e.g., micro-seconds level synchronization instead of nano-seconds as in case of DL-TDOA and UL-TDOA positioning).

Figure 85 illustrates the principle of obtaining distance information from two-way time-of-arrival measurements (UL and DL measurements).

**Figure 85: Principle of Multi-RTT using UL and DL measurements**

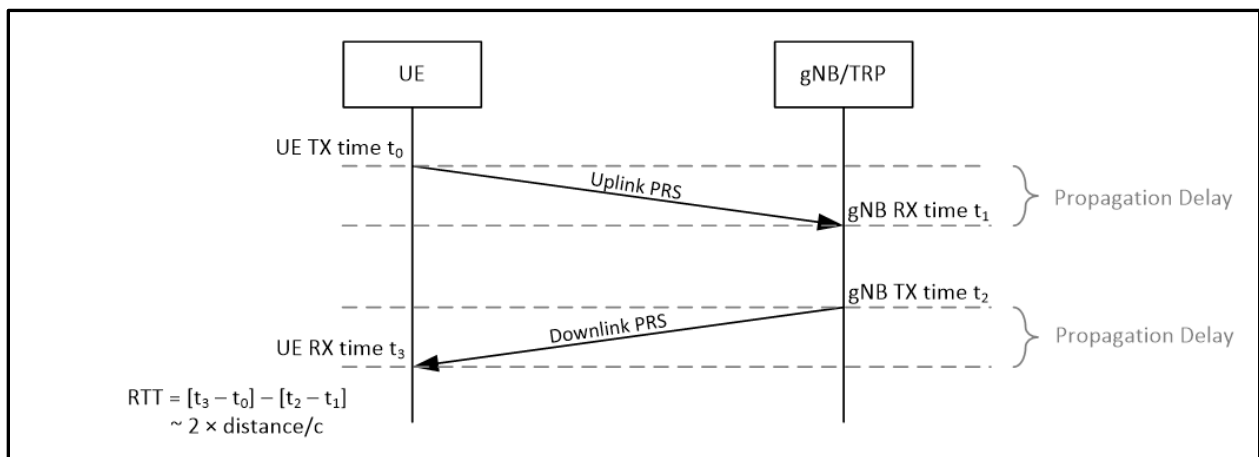

The measurements to support multi-RTT are the *UE Rx-Tx Time Difference* and *gNB Rx-Tx Time Difference* Measurement. In the example of Figure 85, the UE Rx-Tx Time Difference corresponds to  $(t_3 - t_0)$  and the e corresponds to  $(t_1 - t_2)$ , and therefore, the RTT would be *UE Rx-Tx Time Difference* + *gNB Rx-Tx Time Difference* (note, the  $(t_1 - t_2)$  difference would be negative in this example, since  $t_2$  occurs after  $t_1$ ).



From the above it should be noted that Multi-RTT positioning requires both DL and UL procedures as illustrated in Figure 86, which shows a typical procedure on how such operation could take place. Specifically, the following steps are envisioned:

- ❑ Step 1: the location server (LMF) may request the positioning capabilities of the UE using the LPP Capability Transfer procedure.
- ❑ Step 2: In order to obtain UE UL signal information, the LMF may send a NRPPa message to the serving gNB of the UE to request SRS for Positioning configuration information for the UE.
- ❑ Step 3: The serving gNB determines the resources available for SRS for Positioning, and configures the UE with the UL-PRS Resources at step 3a.
- ❑ Step 4: The serving gNB provides the SRS for Positioning configuration information to the LMF in a NRPPa message.
- ❑ Step 5: The LMF then provides the SRS for Positioning configuration to the selected gNBs in a NRPPa message. The message includes all information required to enable the gNBs/TRPs to perform the UL measurements.
- ❑ Step 6: The LMF sends the DL PRS Assistance Data message to the UE
- ❑ Step 7: A Request Location Information message is sent to request the UE measurements. The UE transmits the UL-PRS according to the time domain behaviour of UL-PRS resource configuration from step 3a.
- ❑ Step 8: The UE performs the UE Rx-Tx Time Difference measurements from all gNBs provided in the assistance data at step 6, and each gNB configured at step 5 measures the gNB Rx-Tx Time Difference based on UL transmissions from the UE.
- ❑ Step 9: The UE reports the UE Rx-Tx Time Difference measurements to the LMF and
- ❑ Step 10: each gNB reports the gNB Rx-Tx Time Difference measurements to the LMF.
- ❑ Positioning Estimation step: The LMF determines the RTTs from the UE and gNB Rx-Tx Time Difference Measurements for each gNB for which corresponding UL and DL measurements were provided at steps 9 and 10 and calculates the position of the UE.

It should be noted that the procedure described above includes actually also the steps that would be needed for DL-only positioning (DL-TDOA, DL-AoD) or UL-only positioning (UL-TDOA, UL-AoA) as special cases; for DL-only positioning the steps 2, 3, 4, 5, 8b, and 10 are not needed, whereas for UL-only positioning, the steps 6, 7, 8a and 9 are not needed.

**Figure 86: Exemplary Multi-RTT Positioning Procedure.**

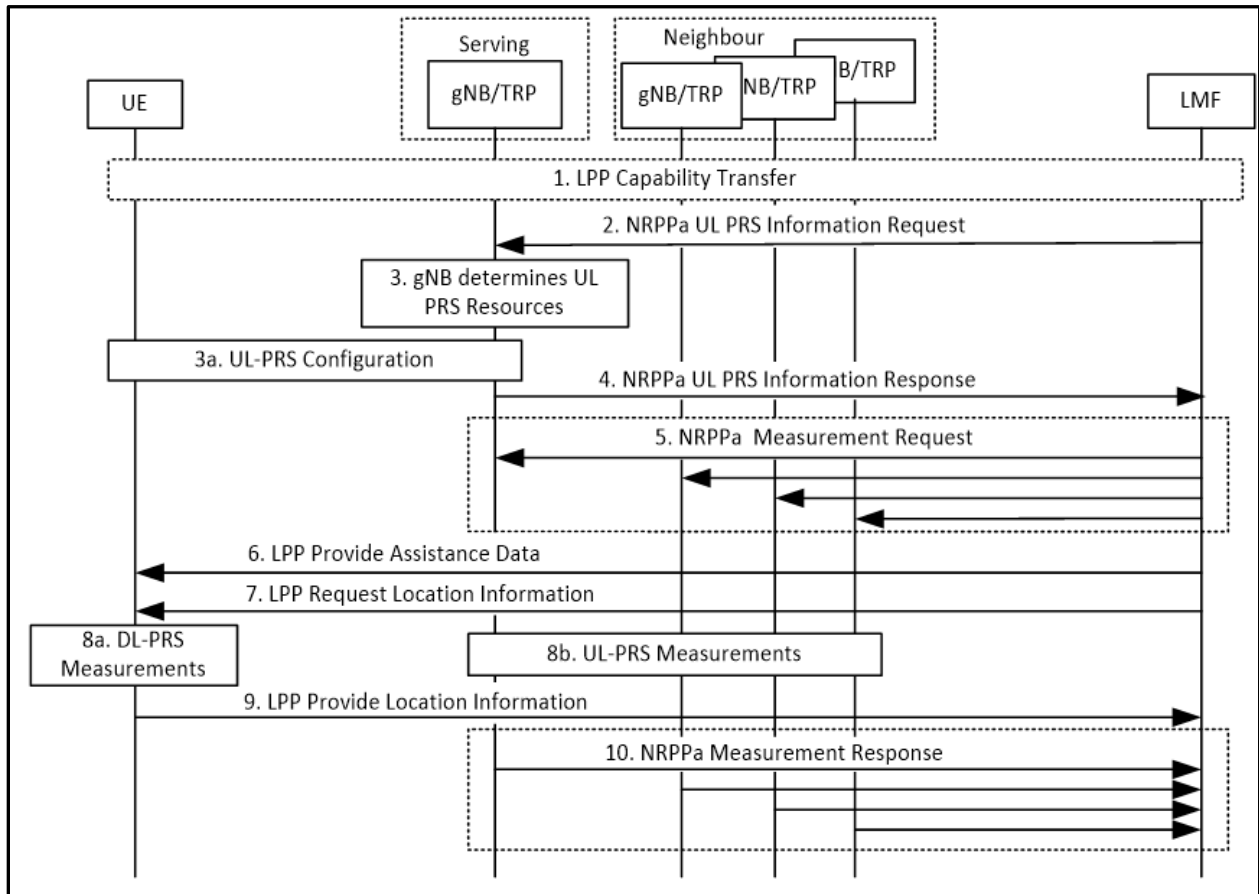

### Enhanced Cell-ID (E-CID) Positioning

Cell-ID (CID) positioning is another network-based technique that can be used to estimate the position of the UE quickly, but typically with relative low accuracy. In the simplest case, the position of the UE is estimated to be the position of the base station it is camped on, however in 5G NR, the Enhanced Cell-ID (E-CID) refers to the positioning method in which the Radio Resource Management (RRM) Measurements are being re-used for position location of a UE (the measurements done for operations such as handover to a neighbor cell, such as Reference Signal Received Power (RSRP) or Reference Signal Received Quality (RSRQ)).

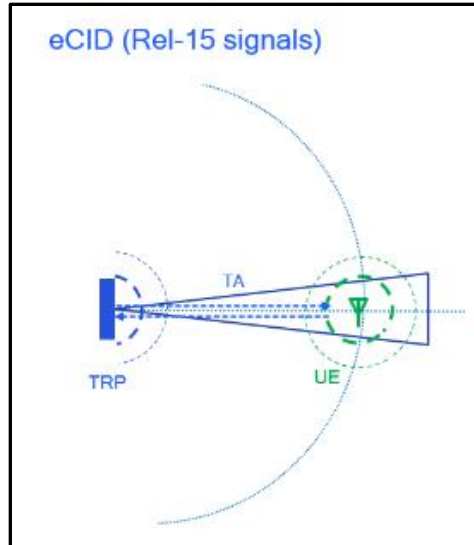

In the E-CID positioning, the UE would report the RRM measurements already available (i.e., and not derived on NR R16 Positioning reference signals) to the LMF.

## Main PHY-layer Enhancements

### DL Positioning Reference Signals (DL PRS)

**Table 22: Usage of DL PRS and associated NR Positioning measurements and methods**

DL/UL Reference Signals	UE Measurements	To facilitate support of the following positioning techniques
Rel.16 DL PRS	DL RSTD	DL-TDOA
Rel.16 DL PRS	DL PRS RSRP	DL-TDOA, DL-AoD, Multi-RTT
Rel.16 DL PRS / Rel.16 SRS for positioning	UE Rx-Tx time difference	Multi-RTT

A variety of configurations are supported in the specification to enable NR Positioning to be applicable in a variety of deployments (e.g., indoor, outdoor, sub-6, mmW). In short, a DL PRS resource corresponds to a collection of resource elements arranged in a particular time/frequency pattern inside which pseudo-random QPSK sequences are transmitted from one antenna port of a TRP.

A UE can be configured with one or more DL PRS resource set(s) from each TRP. Each DL PRS resource set consists of  $K \geq 1$  DL PRS resource(s), each one corresponding to a Tx beam. A DL PRS Positioning Frequency Layer is defined as a collection of DL PRS Resource Sets which have the following common parameters:

- the same SCS and CP type

- ❑ the same value of DL PRS Bandwidth and the same center frequency
- ❑ the same value of comb-Size

A UE can be configured with up to 4 DL PRS Positioning Frequency Layers.

**Figure 87: Structure of DL PRS configuration in NR**

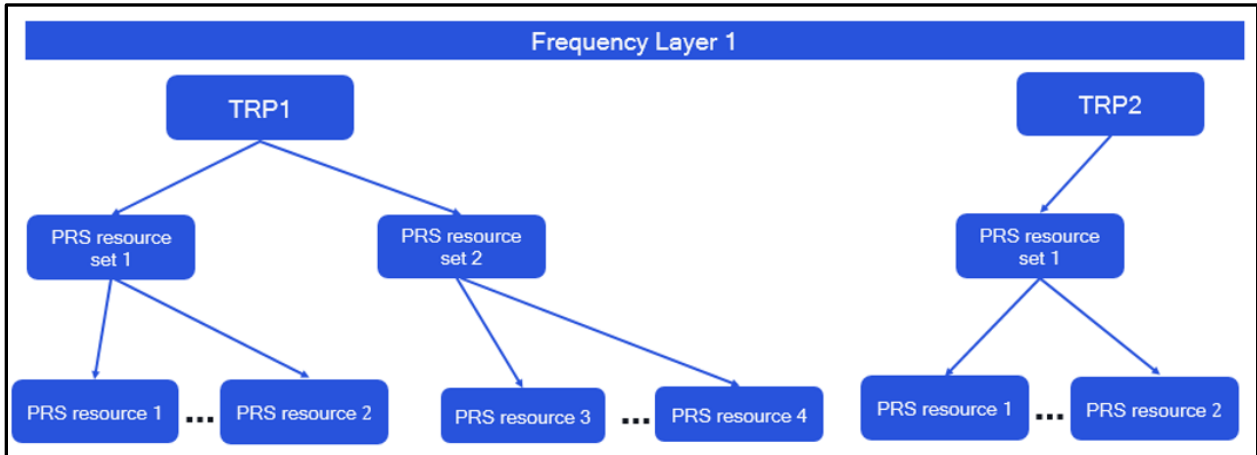

Within a slot, a DL-PRS resource can be configured to span 2, 4, 6, or 12 consecutive OFDM symbols in any higher-layer configured downlink or flexible symbol anywhere in the slot. With regards to the frequency domain pattern, a DL PRS resource has a comb-like pattern, as illustrated in Figure 88, which means that a QPSK symbol is transmitted on every Nth subcarrier, where N can take the values 2, 4, 6, or 12 (All potential combinations of comb-type and number of symbols within a slot are shown in Table 23).

**Table 23: Time/Frequency pattern of a DL PRS resource within a slot in NR**

	2 symbols	4 symbols	6 symbols	12 symbols
<b>Comb-2</b>	{0,1}	{0,1,0,1}	{0,1,0,1,0,1}	{0,1,0,1,0,1,0,1,0,1,0,1}
<b>Comb-4</b>	NA	{0,2,1,3}	NA	{0,2,1,3,0,2,1,3,0,2,1,3}
<b>Comb-6</b>	NA	NA	{0,3,1,4,2,5}	{0,3,1,4,2,5,0,3,1,4,2,5}
<b>Comb-12</b>	NA	NA	NA	{0,6,3,9,1,7,4,10,2,8,5,11}

Example of a subset of the supported patterns are shown in Figure 88. It should be noted that in all cases supported in NR, a DL PRS resource is transmitted in at least as many OFDM symbols as the comb-type; for example, if the comb-type is 4, the PRS resource spans at least 4 symbols. Such a design ensures that a UE can sample all the subcarriers in the configured bandwidth to avoid time-domain aliasing and spurious peaks in the time-domain channel response.

**Figure 88: Examples of DL PRS patterns supported in NR Rel-16 Positioning**

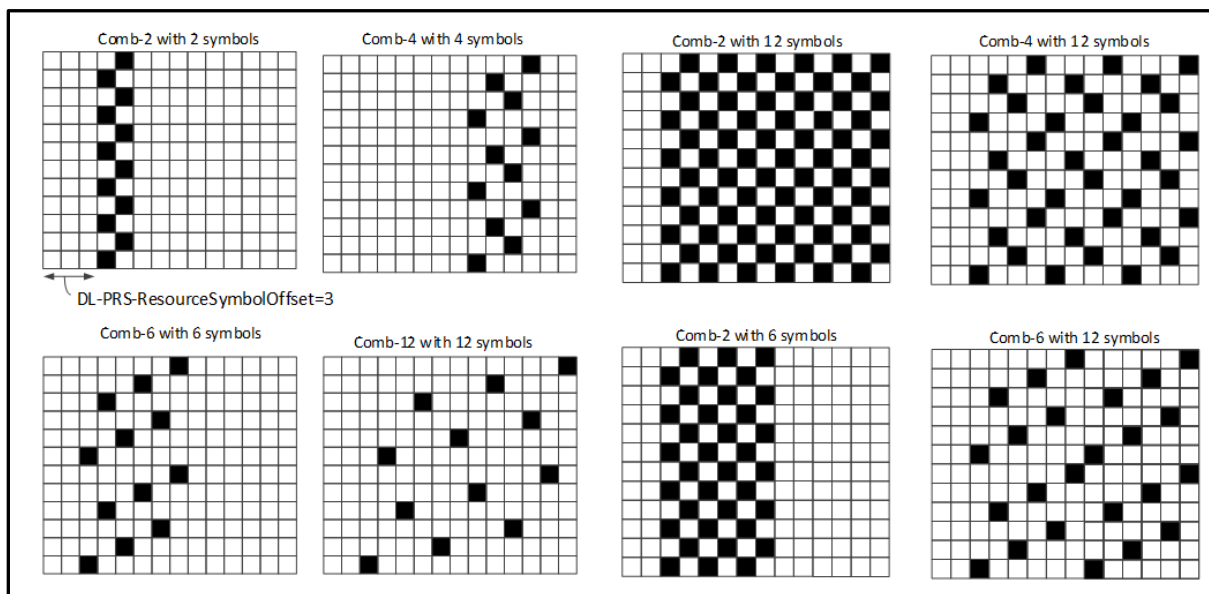

The minimum transmission bandwidth of PRS is 24 contiguous Physical Resource Blocks (PRBs), and a maximum transmission bandwidth of 272 PRBs, which, for different SCS corresponds to different Bandwidth in MHz: For 15 kHz subcarrier spacing, the minimum DL-PRS bandwidth is about 5 MHz, and the maximum about 50 MHz. With a 120 kHz subcarrier spacing, the DL-PRS bandwidth can be up to about 400 MHz.

A DL-PRS resource can be configured to be repeated across slots as follows:

- ❑ Using the configuration PRS-ResourceRepetitionFactor, one can control the number of times each PRS Resource is repeated for a single instance of the PRS Resource Set.
- ❑ Using the PRS-ResourceTimeGap, the offset in units of slots between two repeated instances of a DL PRS Resource corresponding to the same PRS Resource ID within a single instance of the DL PRS Resource Set is chosen.

**Figure 89: Examples of DL PRS Patterns Supported in NR Rel-16 Positioning**

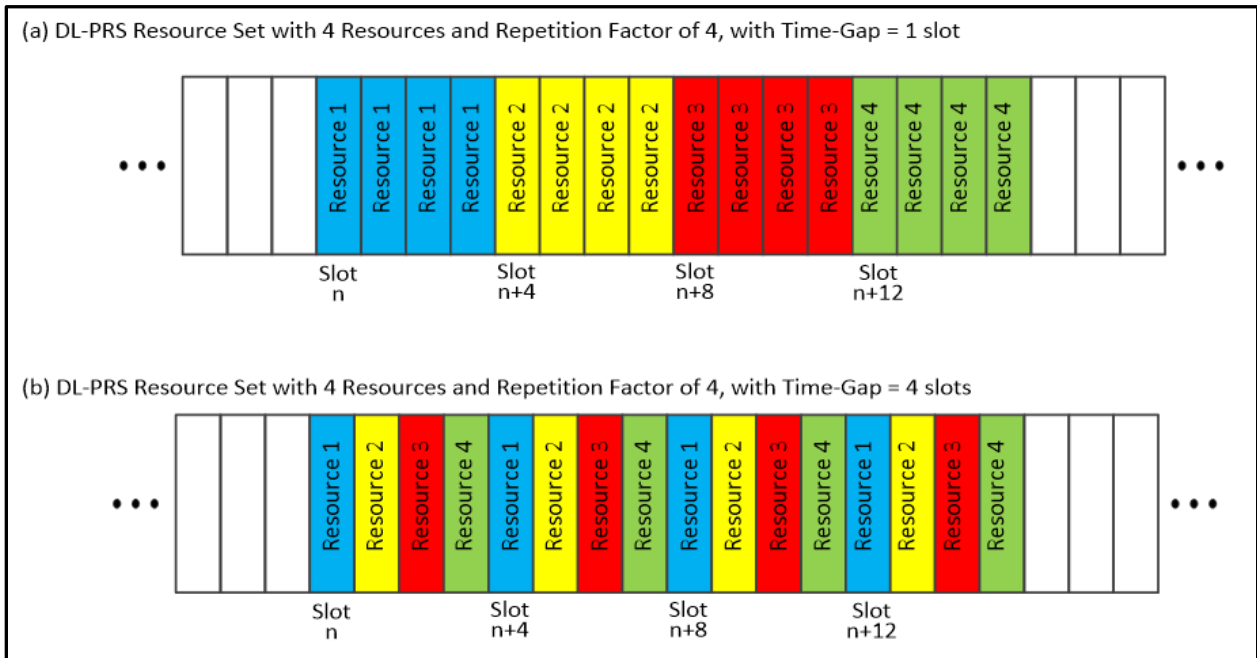

Using the above two configurations, a variety of different types of DL-PRS resource repetitions can be enabled, as shown in Figure X.4.1-4. Repetition of DL-PRS resources has several purposes: First, it enables combining at the Receiver for the purpose of coverage extension. Second, it enables Rx beam sweeping across the repetitions in FR2, and third, enables the Muting feature of “Intra-instance Muting” as described later in this section.

Similar to LTE, muting of DL-PRS Resources is also supported in NR Positioning: Muting can turn-off DL-PRS Resources to reduce the interference in case of colliding DL-PRS Resources across TRPs. Muting is signaled using a bit-map to indicate which configured DL-PRS Resources are transmitted with zero-power. Two muting options are supported for NR as illustrated in Figure 90.

**Figure 90: Two Muting Options in NR Positioning**

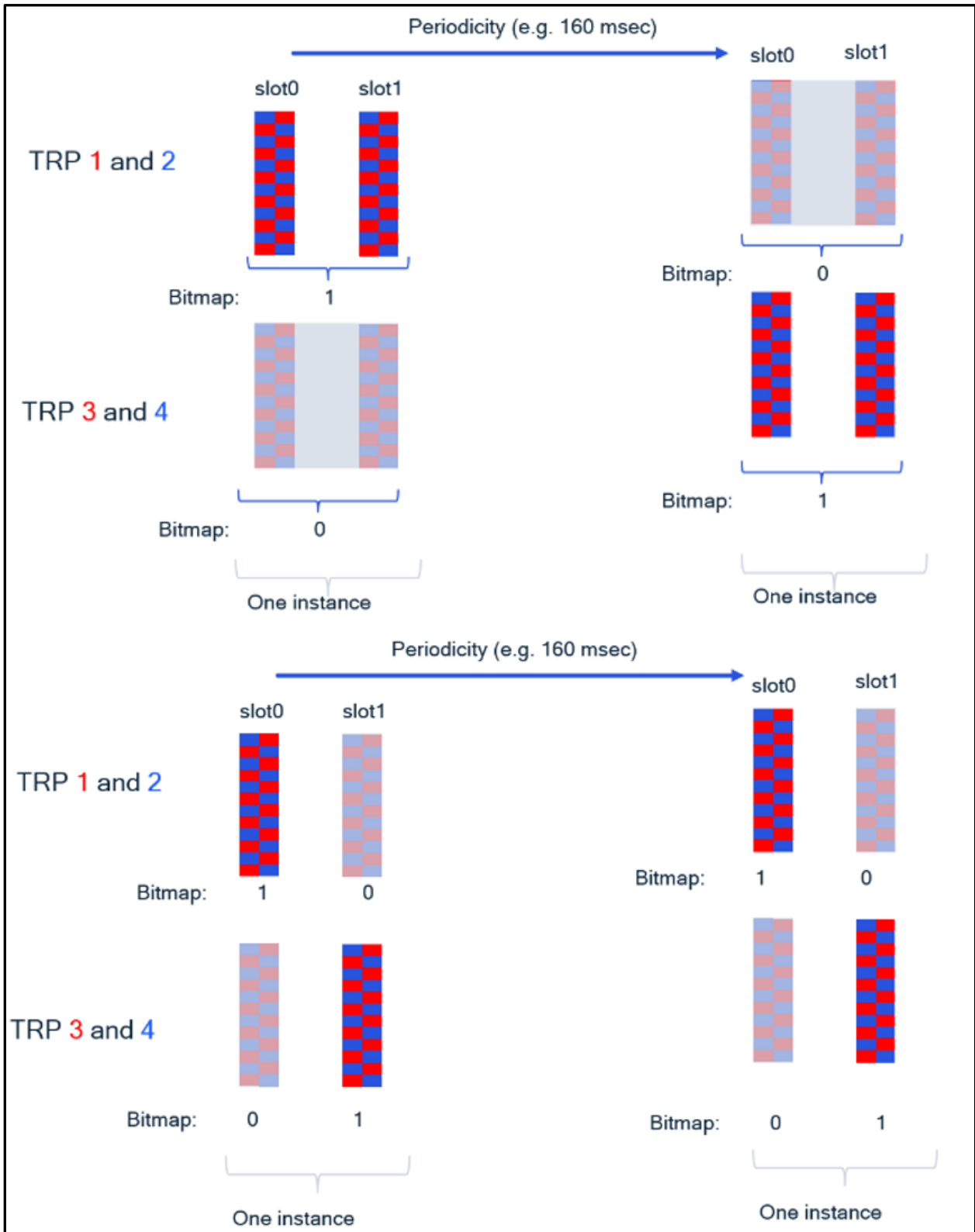

- ❑ Option 1: Inter-instance Muting (similar to LTE). Muting is applied on each transmission instance of a PRS Resource Set. Each bit in the bit map corresponds to a configurable number of consecutive instances of a PRS Resource Set controlled by PRS Muting-Bit Repetition Factor, with values {1, 2, 4, 8}.
- ❑ Option 2: Intra-instance Muting. Each bit in the bit map corresponds to a single repetition of the PRS Resource within an instance of a PRS Resource Set

It should be noted that Option 1 and Option 2 muting can also be used together, by applying the logical AND operation (i.e., a DL-PRS Resource is transmitted when both bits in Option 1 and Option 2 strings have the value 1).

**UL Positioning Reference Signals (SRS for Positioning)**

In NR Rel-16 Positioning, the UL Positioning Reference Signal is based on the NR Rel-15 Sounding Reference Signals (SRS) with enhancements and adjustments for positioning purposes which are summarized later in this section. The SRS for positioning of NR Rel-16 can be used for the all the NR positioning-related measurements and methods as shown in Table 24.

**Table 24: NR Positioning measurements and methods derived based on SRS for Positioning**

DL/UL Reference Signals	gNB Measurements	To facilitate support of the following positioning techniques
Rel.16 SRS for positioning	UL RTOA	UL-TDOA
Rel.16 SRS for positioning	UL SRS-RSRP	UL-TDOA, UL-AoA, Multi-RTT
Rel.16 SRS for positioning, Rel.16 DL PRS	gNB Rx-Tx time difference	Multi-RTT
Rel.16 SRS for positioning,	AoA and ZoA	UL-AoA, Multi-RTT

Similar to DL PRS resource, an SRS resource for positioning may span a consecutive number of OFDM symbols (1, 2, 4, 8 or 12 consecutive OFDM symbols which can be located anywhere in a slot), and the frequency-domain pattern has a similar frequency domain staggering as that of the DL PRS resources. In contrast to DL PRS through, an SRS for positioning is configured by the serving gNB and transmitted within the active UL bandwidth part (BWP) of the UE. To identify which Radio resources should be used for the transmission of the SRS for positioning, the serving gNB exchanges messages with location server so that coordination across multiple reception points participating in a positioning session (e.g. neighbouring TRPs) is possible. The specified combinations are summarized in Table 25.



**Table 25: Time/Frequency Pattern of an SRS Resource for Positioning within a Slot in NR**

Number of symbols Comb size	1	2	4	8	12
2	{0}	{0, 1}	{0,1, 0,1}	N/A	N/A
4	N/A	{0, 2}	{0,2,1,3}	{0,2,1,3, 0,2,1,3}	{0,2,1,3, 0,2,1,3}
8	N/A	N/A	{0,4,2,6}	{0,4,2,6,1,5,3,7}	{0,4,2,6,1,5,3,7,0,4,2,6}

**Figure 91: Examples of SRS for Positioning Patterns Supported in NR Rel-16 Positioning**

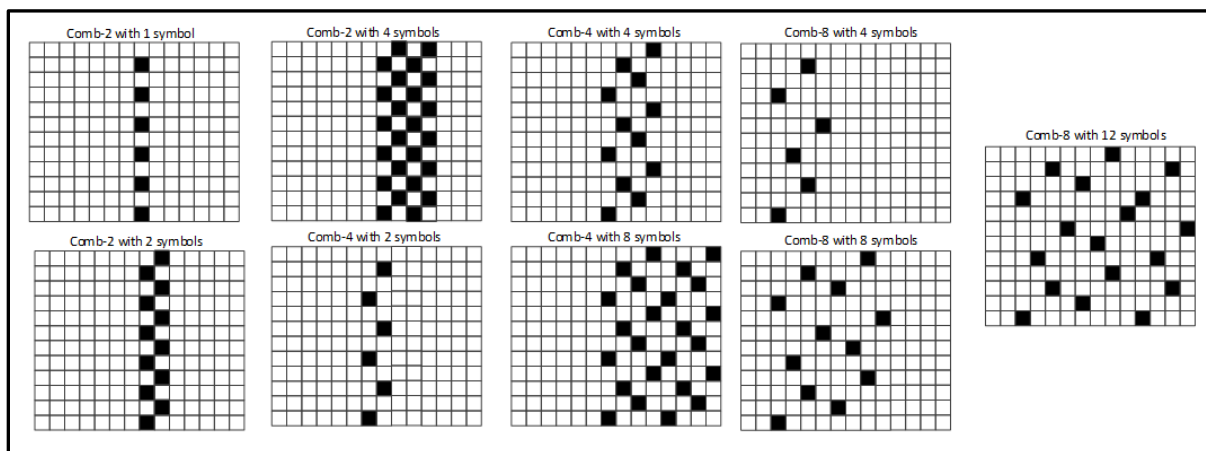

Similar to Rel-15 SRS, an SRS for positioning can be configured for periodic, semi-persistent (MAC-CE activated/deactivated), or aperiodic (DCI-based triggered) transmission (whereas DL PRS resources are only periodic). A few main adjustments and enhancements of NR SRS for Positioning compared to regular SRS are the following:

- ❑ Multi-symbol SRS resources for positioning are staggered in frequency as shown in Table 25 and Figure 91.
- ❑ An SRS resource for positioning is a single port, whereas the regular SRS can be multiple ports.
- ❑ Frequency hopping for SRS for positioning is not supported in Rel-16.
- ❑ Spatial relation indication for SRS for positioning is supported, but compared to regular SRS, the SRS for positioning can have a spatial relation to a neighbour TRP. Specifically, as it is well understood, for positioning, the transmitted signal needs to be received also by neighbouring TRPs. To determine an appropriate Tx beam towards neighboring TRPs, the UE, using reciprocity, may train the Rx beam when receiving DL reference signals from the neighboring TRPs (either SSB or DL-PRS), and then use the reciprocal Tx beam to transmit the SRS for positioning.

- Only open-loop power control is supported, including support for (fractional) path-loss compensation to serving and neighboring TRPs, where the UE estimates the uplink path loss for serving and neighboring TRPs based on downlink measurements and sets the SRS transmit power accordingly.

## Main Upper-layer Enhancements

### LPP for NR Positioning

For the positioning procedures and signaling between a 5G Core Network (5GCN) location server, referred to as Location Management Function (LMF), and a target UE, the Long-Term Evolution (LTE) Positioning Protocol (LPP) is being used [4]. Interestingly, even though LPP was initially specified for 3GPP LTE Release 9, it has been relatively easy to be extended with the new technologies as they are being specified (e.g. NR Positioning, sensors, Bluetooth, WiFi, AGNSS, and more as shown in Table 26.

**Table 26: LPP Supported Positioning Methods**

	LPP Supported Positioning Methods		
	Method	UE-based	UE-assisted
LTE/NB-IoT	OTDOA	No	Yes
	E-CID	No	Yes
RAT-Independent	A-GNSS	Yes	Yes
	Sensor	Yes	Yes
	WLAN	Yes	Yes
	Bluetooth	No	Yes
	TBS	Yes	Yes
NR	DL-TDOA	Yes	Yes
	DL-AoD	Yes	Yes
	Multi-RTT	No	Yes
	NR E-CID	No	Yes
	UL-TDOA <sup>(1)</sup>	No <sup>(2)</sup>	No <sup>(2)</sup>
	UL-AoA <sup>(1)</sup>	No <sup>(2)</sup>	No <sup>(2)</sup>
NOTE 1: Only LPP Capability Transfer			
NOTE 2: NW-based method			

In LPP, a target UE and the LMF communicate in transaction basis, with each transaction being considered as an independent procedure. It is possible that multiple procedures are in progress at a given instance. Each procedure has a single objective, e.g., transfer of assistance data, exchange of capabilities, or positioning of a UE. LPP supports all NR Positioning methods presented in Section 3 and supports capability exchange for UL positioning (UL-TDOA, UL-AoA), even if the SRS for positioning are actually configured by the serving gNB of the target UE through the RRC protocol.

**Figure 92: Example of a UE Positioning Procedure in LPP**

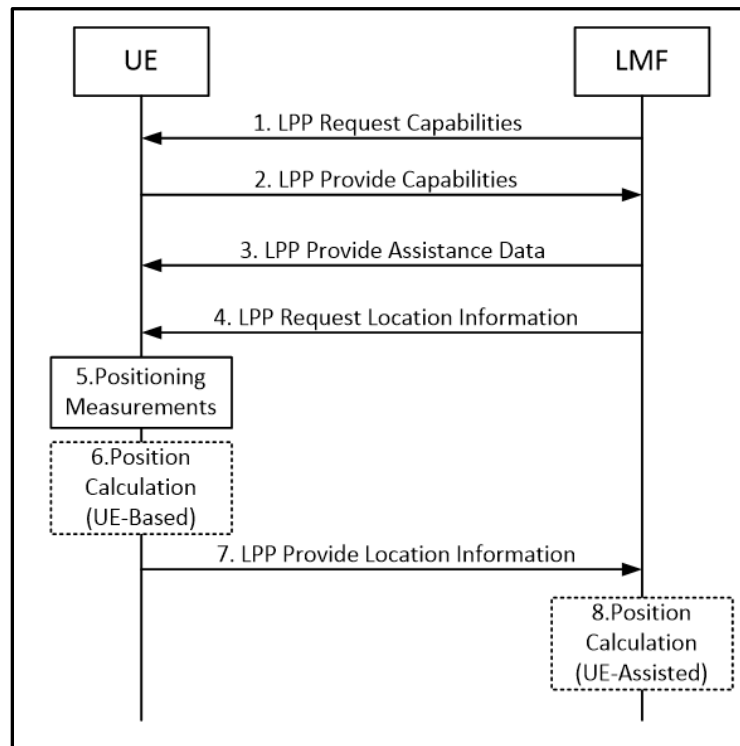

For example, a typical positioning procedure is expected to start with the LMF requesting the positioning capabilities (Step 1 & 2 in Figure 92). Using these capabilities, the LMF may decide the positioning method(s) to configure to the UE. In Step 3, the LMF provides the assistance data to the UE which is different for different methods (e.g., a list of TRPs and corresponding PRS configurations). At Step 4, the LMF then sends a request of positioning measurements, and at Step 5, the UE then performs the requested positioning measurements (in case of UE-based positioning, the UE calculates the position at Step 6). Finally, at Step 7, the UE provides the position estimate to the LMF (in case of UE-based positioning), otherwise the UE reports the position measurements and the LMF estimates the UE positioning at Step 8.

### **UE-based NR DL-only positioning methods**

In LTE, OTDOA relies on the network server to solve for the target device position (i.e., UE-assisted Positioning). This is typically due to the confidential treatment of the network information by the operators, such as TP locations and network synchronization. However, this limits the implementation of UE-based positioning and their hybridisation with e.g. RAT-independent methods (e.g., GNSS, sensors, etc.). For instance, for applications that require an immediate response at the mobile device, the latency of the position calculation in UE-assisted positioning is inherently longer than UE-based methods.

NR Rel-16 positioning introduced, in addition to UE-assisted TDOA (similar to LTE), the support of UE-based positioning for DL-only (DL-TDOA and DL-AoD) methods for the following reasons:

- ❑ Enables Low latency positioning: Position fixes can be produced significantly faster after making the measurements. A UE-assisted alternative would experience delay through RAN and Core Network.

- ❑ Improves scalability: Data reduction can be done on the UE, and there's no inherent computational capacity limit involved with adding more UEs. The UE-assisted alternative requires the location management function serving a multitude of users, and the LMF would have an upper capacity limit.
- ❑ Enables new use cases: NR is driven by commercial requirements with support for location-hungry applications on the UE. Mobility use cases include UE tracking, XR, automotive, factory automation, UE navigation, gaming, etc.
- ❑ Enables improved performance of existing use cases: Fusion with other measurement types available on the UE can improve accuracy, availability, responsiveness, integrity and overall reliability of positioning
- ❑ Decreases UL overhead: If the UE is also the consumer of the location information, no UL data is required. Even if the UE is not the end-user of the location information, the UE location data content is small. Conversely, the UE-assisted alternative would require reporting of a multitude of measurement information with significantly larger data volume.

UE-based DL-only NR Positioning methods are enabled in NR Rel-16 Positioning by introducing support of sending the necessary assistance data (either in dedicated mode or broadcast mode) which include:

- ❑ Physical 3D location of the TRPs: the location server can provide the coordinates of the antenna reference points (ARP) for a set of TRPs. For each TRP, the ARP location can be provided for each associated PRS Resource ID per PRS Resource Set.
- ❑ Beam Information of the PRS resources: the location server can provide spatial direction information of the DL-PRS Resources (e.g. azimuth and elevation angle of the boresight direction in which a DL-PRS Resource is transmitted on)
- ❑ Real Time Difference (RTD): the relative synchronization difference between two TRPs.

### **Broadcast of Assistance Data**

Broadcast of assistance data corresponds to the transmission of assistance data in positioning System Information Blocks (posSIBs). Such signaling can reduce network signaling and load on network elements, reduce latency in obtaining assistance data at a UE, and reduce UE signaling and power usage. Ciphering of the broadcast assistance data is also supported in NR, which enables controlled access to location assistance data by a network operator.

There are actually 3 posSIBs that are defined for the purpose of DL-only positioning (DL-TDOA and DL-AOD) which include the following 3 assistance data elements:

- ❑ PRS configuration of the TRPs
- ❑ Location Information of the TRPs
- ❑ Real Time Difference (RTD)

For each assistance data element, a separate posSIB-type is defined. PosSIBs are actually carried in RRC System Information (SI) messages and can either be periodically

broadcasted; or broadcasted on-demand (i.e. upon request from UEs); or sent in a dedicated manner to UEs in RRC\_CONNECTED (upon request from UEs).

To understand how this feature works, we provide below a typical example of the steps involved:

1. The LMF prepares the posSIBs and scheduling information. The LMF may cipher the assistance data and segments large assistance data elements.
2. The LMF sends the assistance data groups (per SI message) to the NG-RAN together with scheduling information.
3. The NG-RAN includes the posSIBs in RRC System Information Messages and corresponding scheduling information in SIB1.
4. If the posSIB types were ciphered, the LMF provides the used ciphering keys, together with a validity time and validity area for each key.
5. The ciphering key data are provided to the UE in a Registration Accept message.

**Figure 93: Example Procedure of Broadcast of Assistance Data for NR Positioning**

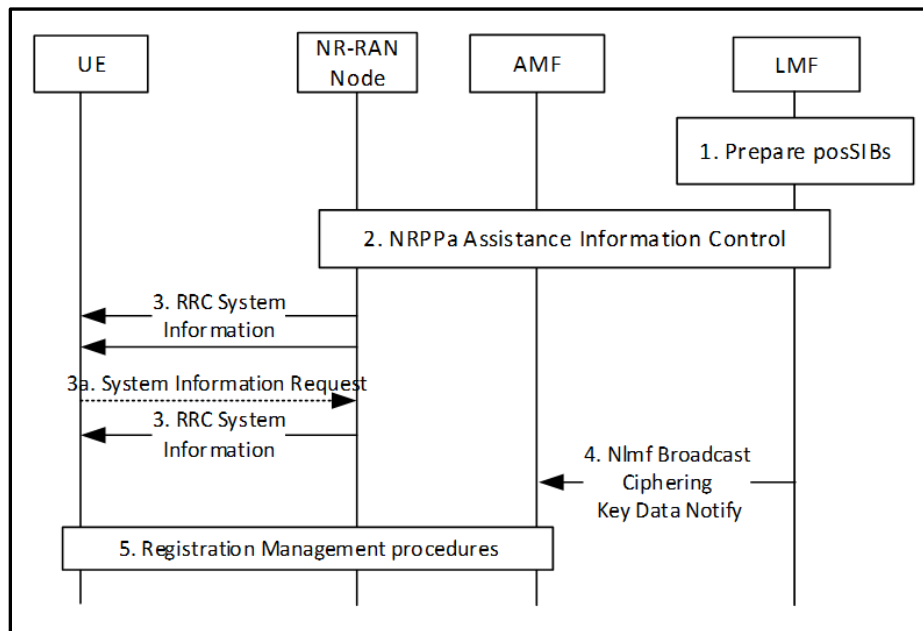

### NR Positioning Outlook

In the previous sections, we summarized the key technologies of NR rel-16. With regards to the accuracy that can be met using these technologies, several evaluations took place across companies in various simulations scenarios (both indoor and outdoor) [6], where it was concluded that accuracy targets suitable for regulatory and some commercial use cases can be met. For example, the following horizontal positioning errors were used as commercial accuracy targets for indoor and outdoor respectively:

- ❑ Horizontal positioning error < 3m for 80% of UEs in indoor deployment scenarios.
- ❑ Horizontal positioning error < 10m for 80% of UEs in outdoor deployments scenarios.

It should be noted however, that in many scenarios, even more strict targets can be met. The simulation campaign and results appearing in [6] took place before NR Rel-16 Positioning hadn't started yet. Recent evaluation results that are performed for the purpose of identifying future enhancements of NR cellular positioning demonstrate that NR Rel-16 Positioning technologies can meet even much stringent accuracy targets. We now provide a few examples for different scenarios:

- 3GPP UMI channel models at 4 GHz carrier frequency (FR1), 100 MHz PRS bandwidth and 30 KHz SCS for ISD of 200 m and outdoor UEs. The 3GPP NR Rel-16 Evaluation Assumptions shown in [6] were used. In addition to the assumptions shown in that document, both realistic network sync error, and RTT group delay calibration error (due to gNB/UE Rx-Tx measurements) are included according to truncated Gaussian distributions  $[-2 \cdot T1, 2 \cdot T1]$  nsec where  $T1$  denotes the RMS error. Both DL-TDOA and Multi-RTT results are shown. We make the following observations:
  - Multi-RTT with realistic group delay calibration error achieves a better horizontal accuracy performance compared to DL-TDOA with realistic network sync error.
  - A hybrid positioning method of Multi-RTT with AoA may achieve a horizontal accuracy of < 3 meters for 80% of the outdoor UEs.

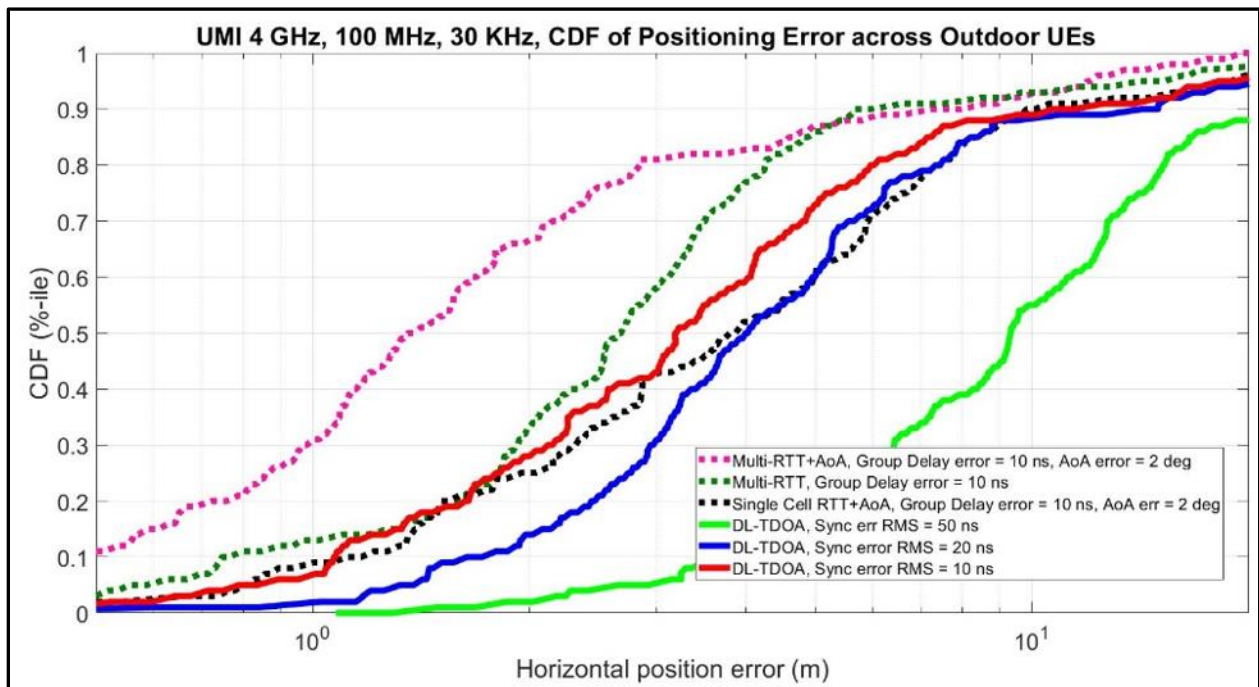

- 3GPP UMI channel models at 30 GHz carrier frequency (FR2), 400 MHz PRS bandwidth and 120 KHz SCS for ISD of 200 m and outdoor UEs. Both DL-TDOA and Multi-RTT results are shown. As it was the case for the UMI FR1 scenario shown above, we observe that Multi-RTT achieves a better horizontal accuracy performance compared to DL-TDOA.

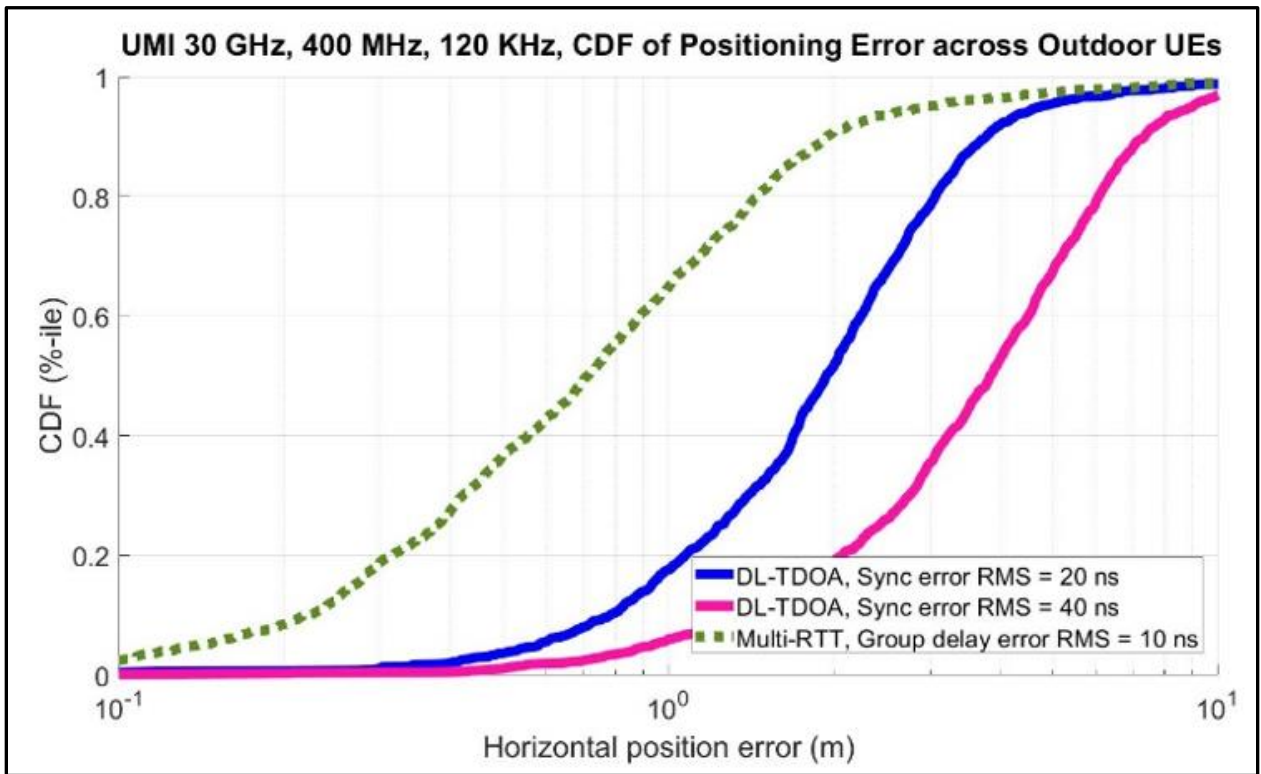

- 3GPP Indoor Factory channel model at 3.5 GHz (FR1) and 38 GHz carrier frequency (FR2), 400 MHz PRS bandwidth and 120 KHz SCS for ISD of 200 m and outdoor UEs.

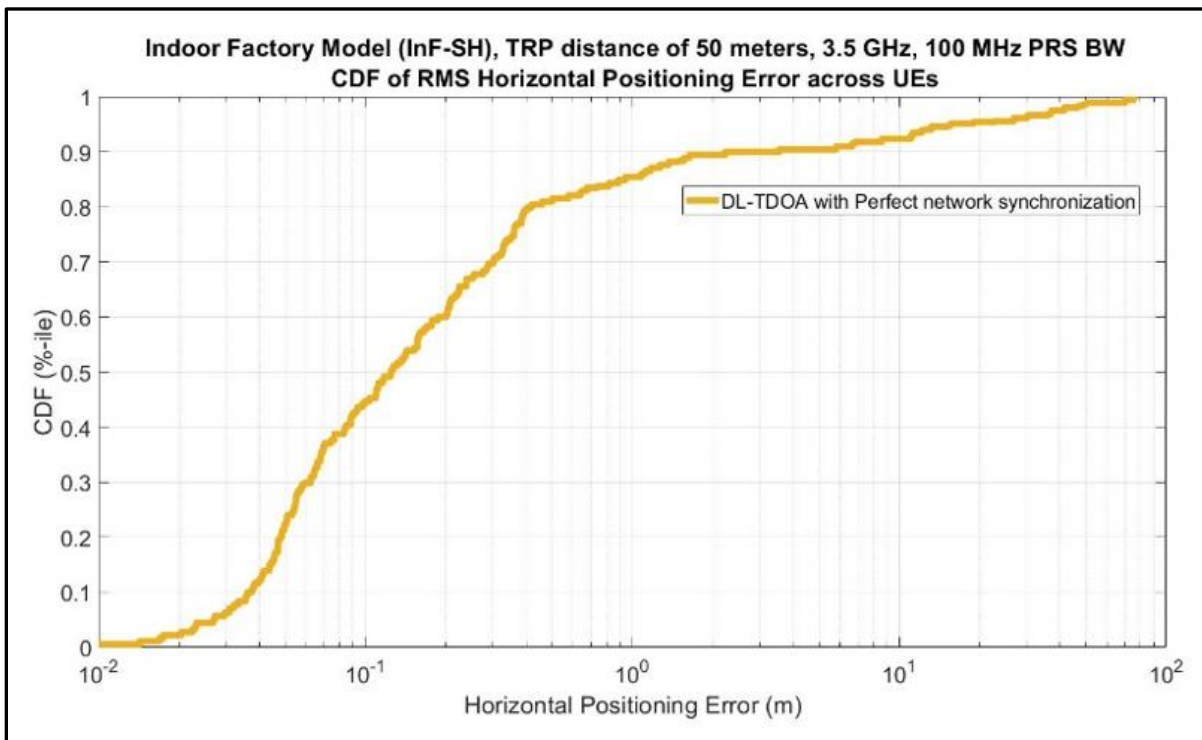

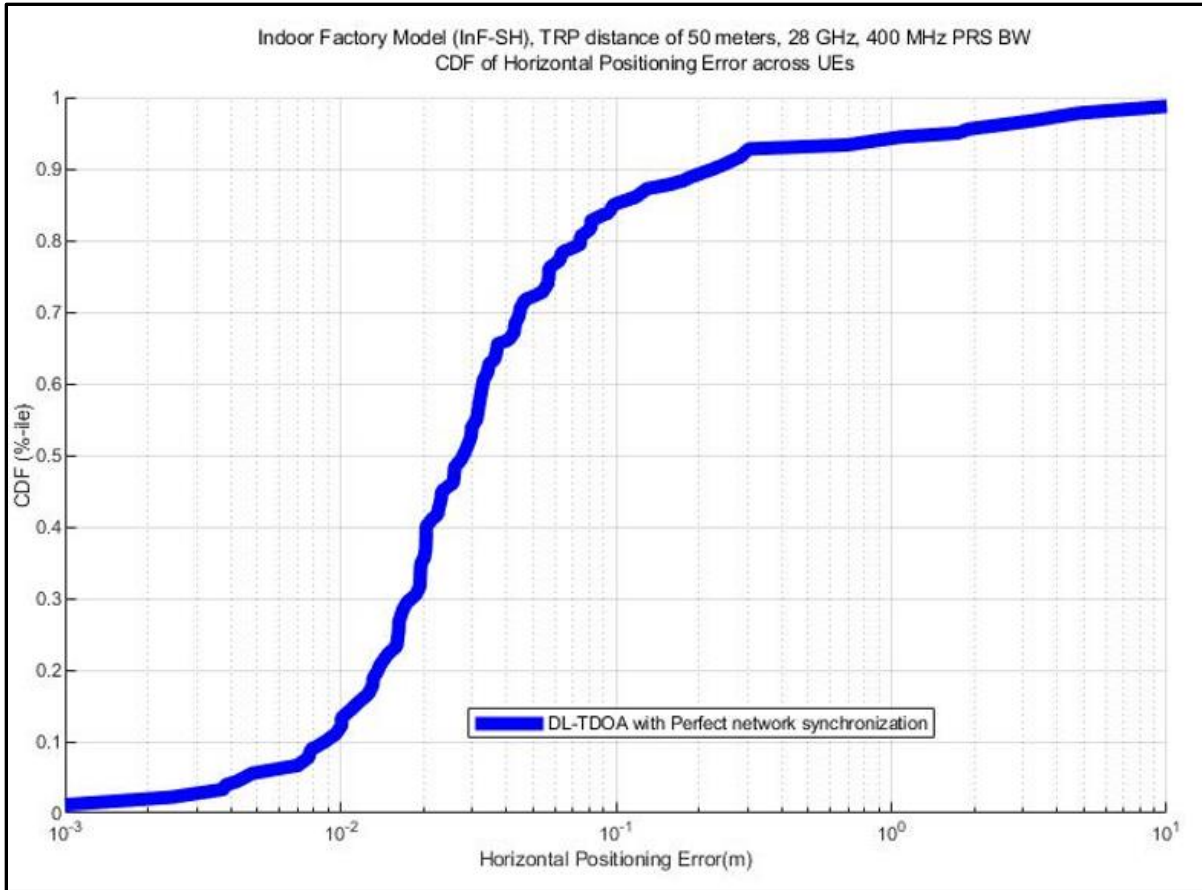

### What is next?

3GPP NR Rel-16 specified several positioning technologies to support both regulatory and commercial use cases. This was however just the first release of NR cellular positioning; the 5G service requirements specified in [1] include High Accuracy Positioning requirements, which are characterized by very ambitious system requirements for positioning accuracy in several important verticals of NR. To address the higher accuracy positioning requirements resulting from new industry verticals, NR Positioning in Rel-17 is currently evaluating enhancements in NR Rel-16 cellular positioning to meet the following exemplary performance targets with regards to accuracy:

General commercial Use Cases of NR Rel-17 Positioning	For IIoT Use Cases of NR Rel-17 Positioning
sub-meter level position accuracy (< 1 m)	position accuracy < 0.2 m

With regards to latency, the target latency requirement is < 100 ms; for some IIoT use cases, latency in the order of 10 ms is desired for NR Rel-17 positioning.

### Conclusions

5G NR Rel-16 Positioning technologies represent a significant new opportunity beyond Emergency Services and regulatory services. Improved accuracies that can meet several



commercial target requirements are possible mainly due to the 5G NR wider bandwidth (e.g. 100 MHz in FR1 and 400 Mhz in FR2) and the large number of antennas at the NR gNBs (e.g., Massive MIMO in both FR1 and FR2). Several NR Positioning methods can be seamlessly combined with RAT-independent methods (e.g., sensors, WiFi, A-GNSS), but also within the NR Native positioning methods (e.g., Angle of Arrival/Departure measurement methods can work complementary to time-based methods). Lastly, NR Positioning has introduced several methods that do not require tight network synchronization (single-cell RTT / multi-cell RTT / AoA / AOD) and therefore decrease the network cost of deploying such features, and making meter-level, and sub-meter-level accuracies possible with cellular positioning.

## References

- [1] 3GPP TS 22.261: *Service requirements for the 5G system; Stage 1.*
- [2] 3GPP TS 23.273: *5G System (5GS) Location Services (LCS); Stage 2.*
- [3] 3GPP TS 38.305: *Stage 2 functional specification of User Equipment (UE) positioning in NG-RAN.*
- [4] 3GPP TS 37.355: *LTE Positioning Protocol (LPP).*
- [5] 3GPP TS 38.455: *NG-RAN; NR Positioning Protocol A (NRPPa).*
- [6] 3GPP TR 38.855: *Study on NR positioning support.*
- [7] 3GPP TS 38.211: *Physical channels and modulation.*
- [8] 3GPP TS 38.213: *Physical layer procedures for control.*
- [9] 3GPP TS 38.214: *Physical layer procedures for data.*
- [10] 3GPP TS 38.215: *Physical layer measurements.*

## Dynamic Spectrum Sharing in Detail<sup>225</sup>

### Driver for DSS

Dynamic Spectrum Sharing (DSS) enables smooth and efficient migration from 4G/LTE to 5G NR by giving both technologies instant access to the same spectrum. DSS design was driven by the following requirements:

- ❑ It should be able to release as much of NR's full potential as possible when LTE traffic intensity is low.
- ❑ NR should have a minimum impact on LTE latency, coverage, and peak rate, at least when NR traffic load is low.
- ❑ All legacy LTE devices should be able to access the network for the deployment to be commercially sound. This implies it is not possible to change the LTE specifications for NR/LTE spectrum sharing.

### 3GPP framework for DSS

---

<sup>225</sup> This section based on contributions from AT&T and Ericsson.

3GPP did not define one monolithic solution for spectrum sharing, but rather a set of tools that can be used for building a spectrum sharing solution for simultaneous operation of LTE and NR. Some of the 3GPP defined tools serve the exclusive purpose of operating NR and LTE on a common carrier. Other NR configurations, such as various PDCCH mappings or demodulation reference signal (DMRS) positions, are vital for spectrum sharing.

The network node (eNB or gNB) operating in DSS mode rapidly allocates the time/frequency resources for the actual user data transmission between LTE and NR, depending on the number of users and priority of their data packets.

An NR device configured with "LTE CRS rate matching" is aware of the resource elements in the time-frequency grid that carry LTE cell-specific reference signals (CRS) and it does not decode NR data on these resource elements. CRS rate matching is available for the NR data channel when using 15kHz subcarrier spacing. For higher subcarrier spacing, LTE CRS rate matching on resource element level is not feasible, as signals transmitted with different numerologies are not orthogonal and cross subcarrier interference would occur between NR data and interleaved LTE reference signals.

In the UL, LTE applies a 7.5kHz (half a subcarrier) shift to all its UL transmissions. An NR device operating with FDD and its UL with 15kHz numerology can be configured to apply the same shift. Without a 7.5kHz shift, a frequency guard between LTE and NR UL is needed.

The 3GPP standard does not give any more additional specific guidance regarding implementation of efficient spectrum sharing for SA or NSA deployments.

Reference 3GPP specifications include: 38.331; 38.214; 38.101; 38.211

### **Device support**

Device support is required for DSS. A network implementation must ensure that broadcast transmissions of LTE and NR (PSS, SSS, MIB, SIBs, TRS and CSI-RS) must be positioned so they are supported by a device operating according to that Radio Access Technology (RAT), but invisible to a device operating on other technology.

### **Methodologies for efficient DSS implementation built on 3gpp framework**

#### *Coordinated scheduling at TTI level*

NR DL and UL data transmissions are kept separate from LTE data transmissions via coordinated scheduling, which implies that scheduling decisions are taken every millisecond.

#### *Using MBSFN subframe to transmit NR common channels*

NR cell in dynamic spectrum sharing configuration may choose to transmit SSB in an LTE multicast-broadcast single-frequency network (MBSFN) subframe which has fewer LTE reference symbols, thereby avoid collision between NR and LTE reference symbols. Other reference symbols of NR can also be transmitted in the MBSFN subframe of LTE.

#### *Transmitting the NR physical control channels*

While the 3GPP specification is very flexible where the PDCCH can be transmitted, the mandatory device capability only requires control channel support within the first three OFDM symbols of a slot. To avoid collisions with LTE CRS, the NR PDCCH is mapped to the

third, or second and third, OFDM symbol in a slot, depending on the LTE reference signal configuration.

#### *Semi-static rate-matching resource set configuration for Downlink*

This functionality enables rate matching around LTE sync and PBCH so that they do not interfere with NR PDSCH. A mandatory feature for capability signaling is to enable the NR UE to perform rate matching for NR PDSCH around semi-statically defined patterns in LTE.

#### **Summary of some key features supporting DSS**

1) LTE CRS rate matching. Ability for NR to map around LTE Cell Specific Reference Signals (CRS):

- ❑ Without CRS rate matching, LTE PDSCH capacity is severely reduced.

2) General rate matching. Similar to CRS rate matching, but maps NR signal around LTE synchronization signal blocks (SSB) and PBCH.

3) Mini Slots. Provide solutions for three areas of concern:

- ❑ Allow NR transmission in normal subframes without CRS rate matching.
- ❑ Mini slot (Type B) PDSCH provides alternative to puncturing solution for NR PDSCH broadcasts in Idle and Inactive modes.
- ❑ In conjunction with other DSS enhancements, mini slots can provide one additional NR PDCCH symbol (total of two), which could be needed for increased PDCCH capacity and/or better NR coverage.

4) MBSFN subframes. Provide almost clear subframes for NR, without risk of collisions with LTE:

- ❑ Extensive use of MBSFN subframes reduces LTE capacity and throughput.
- ❑ Will be used primarily for SSB, PBCH and SIB1 messaging.

5) Extended PRBs. Additional PRBs available to NR, in guard band of LTE carriers. For reference, extended PRBs provide a 4% to 6% boost to NR capacity:

- ❑ 10MHz NR carrier - 2 additional PRBs.
- ❑ 15MHz NR carrier - 4 additional PRBs.
- ❑ 20 MHz NR carrier - 6 additional PRBs.

6) Other features supporting DSS:

- ❑ Flexible Type A PDSCH – DSS solution without mini slots.
- ❑ 7.5kHz UL shift – avoids the requirement for a guard band between LTE and NR uplink.
- ❑ PDCCH in symbol 2 – NR PDCCH immediately follows symbols reserved for LTE PDCCH.
- ❑ TRS in symbol 6 and 10 - Tracking Reference Signal maintains LTE/NR phase alignment.

- Flexible CSI-RS placement.

## Integrated Access and Backhaul in Detail

See the introductory discussion of IAB in the main body of this paper. As a study item for Release 15, 3GPP has specified the use cases and deployment scenarios as well as the architecture options for IAB. IAB is expected to support both outdoor and indoor NR cell deployments; stationary relay nodes with fixed locations will be the main focus of initial work. In future releases, IAB might also be deployed in mobile relay scenarios, for example, on buses or trains.

Access and backhaul may be on the same (in-band) or different (out-of-band) frequencies. In-band operation requires tighter interworking to accommodate duplex constraints and to mitigate interference. IAB will work with 5G in both SA and NSA modes. It will also support multi-hop backhauling and all 5G-specified radio bands. Although specified in Release 16, IAB will be backward compatible with Release 15 UEs.

3GPP studied multiple architectural approaches for IAB in a study item<sup>226</sup> and recommended architecture 1a, currently being standardized in Release 16. In this architecture, backhauling of F1-U uses an adaptation layer, or GPRS Tunneling Protocol User (GTP-U), combined with an adaptation layer; while hop-by-hop forwarding across intermediate nodes uses the adaptation layer for operation with Next Generation Core (NGC) or Packet Data Network (PDN)-connection-layer routing for operation with EPC.

Figure 94 shows examples for operation in SA and NSA modes: a) UE and IAB-node operate in SA with NGC, b) UE operates in NSA with EPC while IAB-node operates in SA with NGC, c) UE and IAB-node operate in NSA with EPC.

**Figure 94: Examples for Operation in SA and NSA Modes<sup>227</sup>**

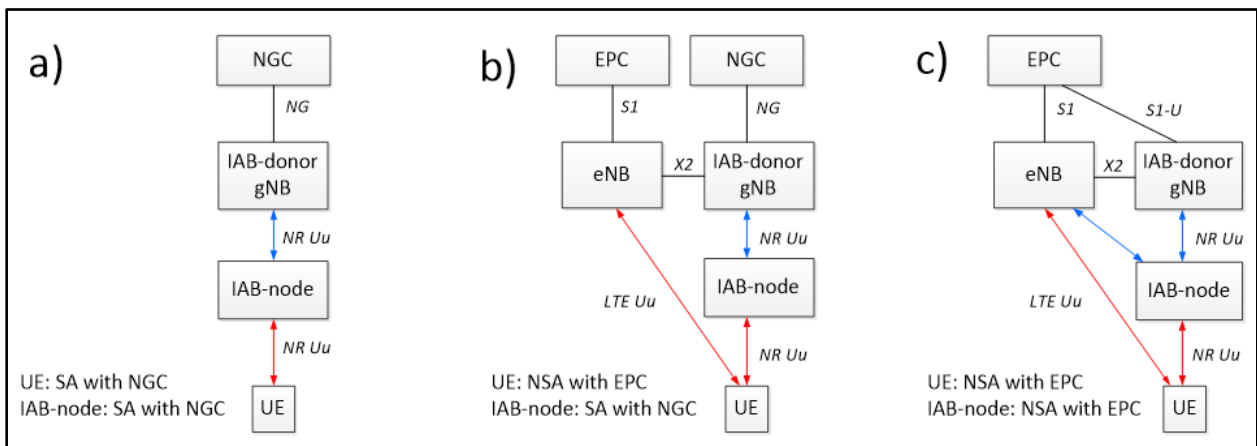
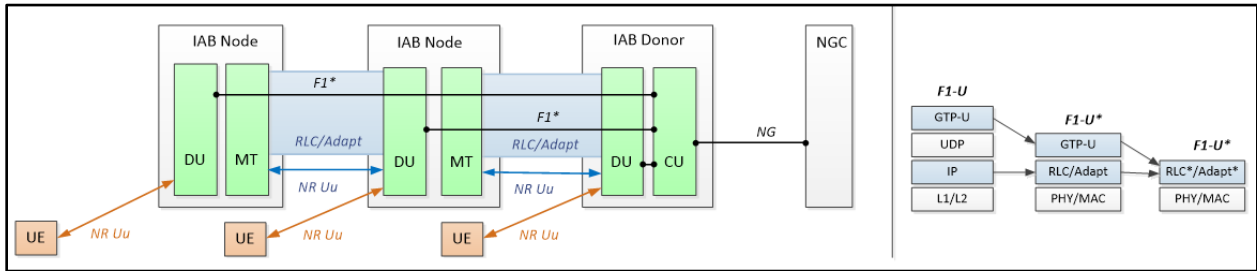

Figure 95 shows the reference diagram for the 1a architecture, which employs a Centralized Unit (CU)/Distributed Unit (DU) split.

<sup>226</sup> 3GPP, *Study on Integrated Access and Backhaul*, Release 16, 3GPP TR 38.874 V16.0.0, Dec. 2018.

<sup>227</sup> Ibid.

**Figure 95: Reference Diagram for Architecture 1a (SA-Mode with NGC)<sup>228</sup>**



The multi-hop capability is flexible, with some nodes communicating over one hop and some over as many as three hops, as shown in Figure 96. The architecture does not restrict the number of hops, and the maximum practical number depends on factors such as frequency, cell density, propagation environment, and traffic load. A performance consideration is that each hop increases latency.

<sup>228</sup> Ibid.

**Figure 96: IAB Network with Three hops and 12 UEs<sup>229</sup>**

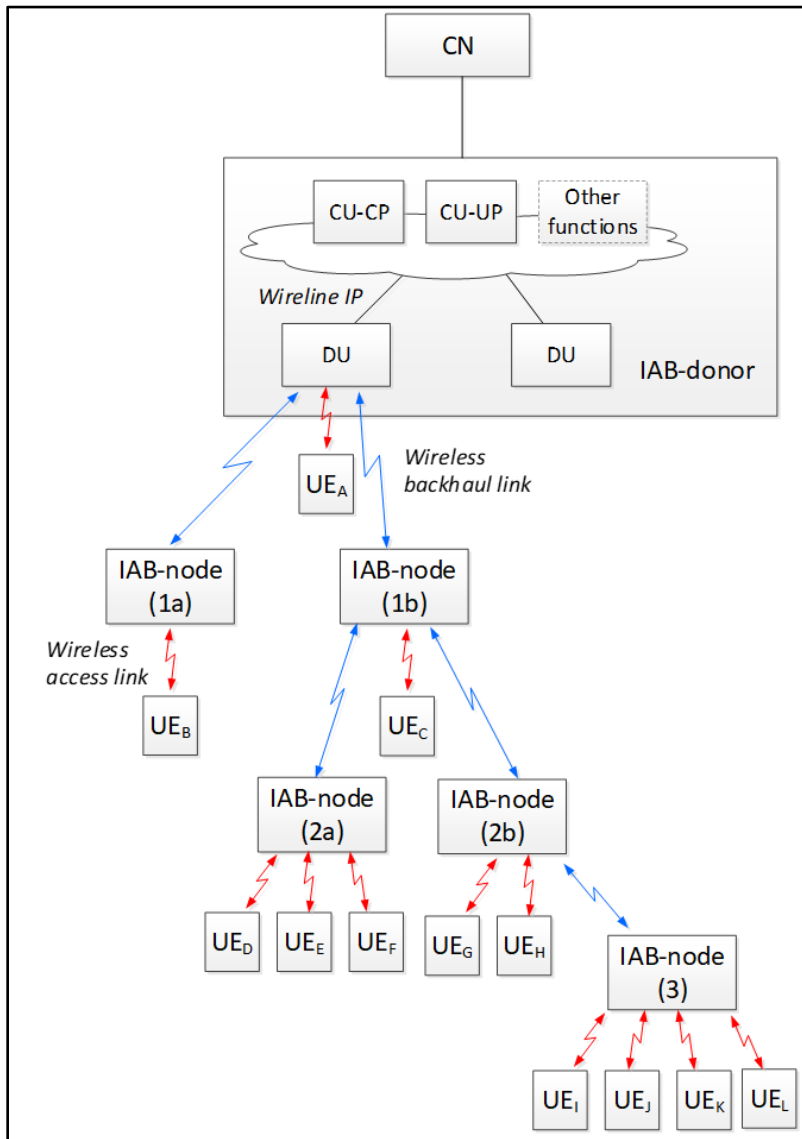

## Performance

See the introductory discussion about 5G performance in the main body of this paper. 5G, with its ability to use wider radio channels than LTE, can deliver much higher peak and average speeds, with initial estimates listed above in the section, "Data Throughput Comparison."

Figure 97 shows real world test results, achieving 2 Gbps of throughput in a line-of-sight connection with a 400 MHz radio channel in a 3:1 TDD configuration.

<sup>229</sup> Ibid.

**Figure 97: 5G NR Downlink Measured Performance<sup>230</sup>**

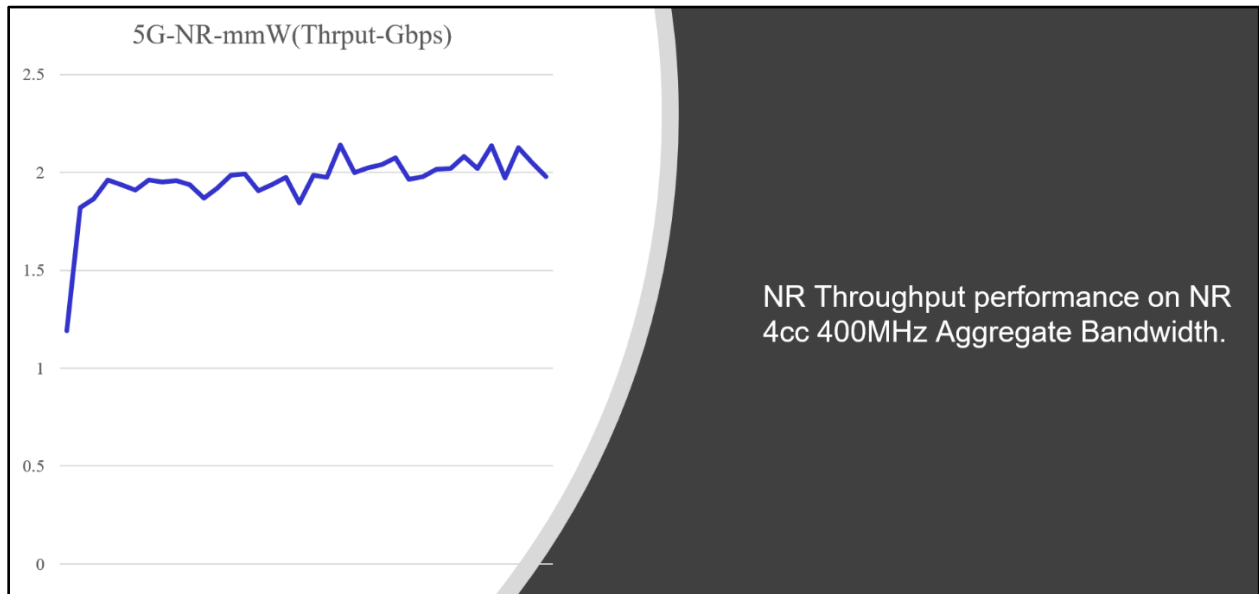

A 5G Americas member contribution shows outdoor testing results in Figure 98, based on field testing of a pre-standards but representative system under the following conditions: line of sight, 28 GHz, 90:10 TDD, 2X2 MIMO, 64 QAM, outdoor macro 10-45 meter in height, and street-level measurement.

**Figure 98: Pre-Standards Outdoor Test, 28 GHz, DL Throughput, 100 MHz<sup>231</sup>**

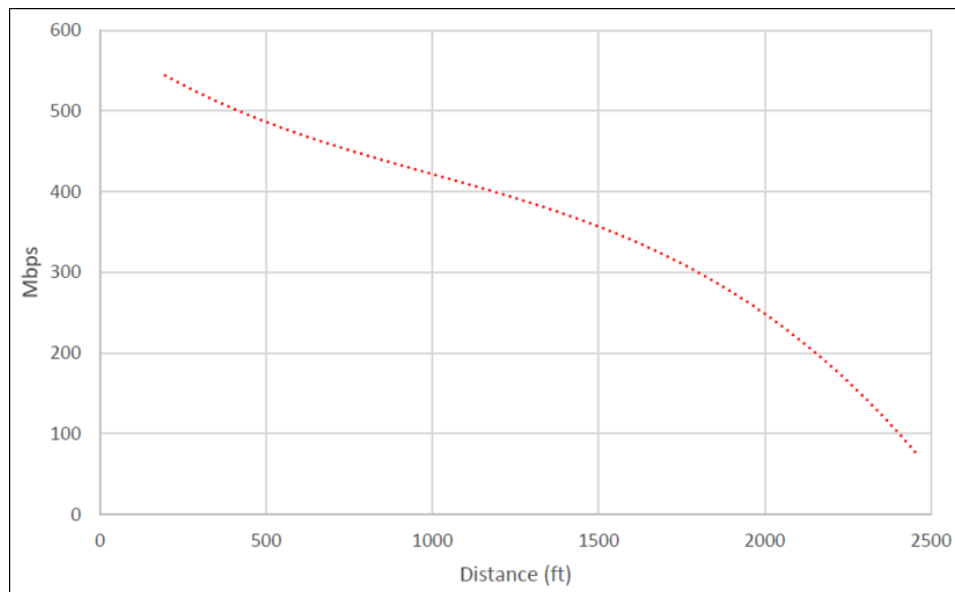

<sup>230</sup> T-Mobile contribution. Horizontal axis is time. Additional test configuration information: direct line of sight with 85° angle of arrival, beam reference signal received power of -82dbm, 2x2 MIMO, 64 QAM, 8 wide beams, 64 narrow beams.

<sup>231</sup> 5G Americas member contribution.

Throughputs will be proportionally higher for bandwidth greater than 100 MHz. In addition, throughputs in non-line-of-sight conditions will be lower, with the decrease depending on the extent of obstructions or nature of signal propagation, such as reflections. Finally, different TDD ratios will proportionally change throughput.

Figure 99 shows simulated downlink performance for a 28 GHz mmWave network using different base station ISDs based on the following simulation parameters.

#### Access Point Parameters:

- ❑ AP512: cross-pol array with 512 physical antenna elements (16,16,2), 256 elements per polarization.
- ❑ Physical antenna elements: 5dBi max gain per physical element, half wavelength spacing between rows and columns, elements have 3dB beamwidth of 90 degrees.
- ❑ Max EIRP = 54dBm and 60dBm (assuming both polarizations are not coherently combined), TX power per PA= -2dBm and 4dBm respectively. Noise figure of 5dB.
- ❑ Single TXRU per polarization. 2TXRUs: SU-MIMO with open-loop rank 2 per UE on DL and UL.

#### User Equipment:

- ❑ UE32: Dual panel cross-pol array, 2 panels oriented back-to-back with best-panel selection at UE. Each panel is (4,4,2) with 32 physical elements per panel, 16 physical elements per polarization per panel, half wavelength spacing between rows and columns.
- ❑ Total TX power fed to active panel = 23dBm. TX power per PA is 8dBm.
- ❑ Physical elements in antenna array panel: 5dBi max gain per physical element, elements have 3dB beamwidth of 90 degrees.
- ❑ Max EIRP = 40dBm in all cases (assuming both polarizations are not coherently combined), noise figure of 9dB.
- ❑ Single TXRU per polarization. 2 TXRUs: SU-MIMO with open-loop rank 2 per UE on DL and UL.

#### Scenarios:

- ❑ 3GPP NR UMi and 3GPP NR UMa channel model (38.901) modified for all UEs located outdoors.
- ❑ 3-sector and 4-sector hexagonal layout with various ISDs: 100m, 200m, 500m, 1000m.
- ❑ Base heights of 10m (UMi) and 25m (UMa).

#### System:

- ❑ System bandwidth = 200MHz and 800MHz bandwidth, TDD split of 50-50 (results can be scaled to other TDD splits).
- ❑ Full Buffer Traffic with PF scheduling, SU-MIMO, average of 15 active UEs per site.



- ❑ Simulation bandwidth=100MHz: TX powers appropriately scaled to properly model 200MHz or 800MHz operation.
- ❑ DL scheduling:
  - UE is scheduled on full system bandwidth (200MHz or 800MHz).
- ❑ UL scheduling: two cases:
  - (A): UE is scheduled across full system bandwidth: UE power is 23dBm into 200MHz or 800MHz.
  - (B): UE is scheduled in 100MHz channels: UE power is 23dBm into 100MHz, UL load is appropriately scaled to model the UL traffic on that 100MHz carrier.

#### Key Parameters:

- ❑ Inter-Site Distances of 100, 200, 500, 1000m.
- ❑ Access Point Heights:
  - UMa with 25m Height.
  - UMi with 10m Height.
- ❑ Deployments with 3 versus 4 sectors:
  - same hardware in a 3-sector deployment as in a 4-sector deployment.
- ❑ Access Point EIRP=54, 60 dBm.
- ❑ Beam Selection/Beam Refinement with open-loop rank2 baseband precoding.

#### Results:

- ❑ 800MHz results.
- ❑ Showing Mean UE throughput, Cell Edge Throughput (5th-percentile throughput), and Mean Site Throughput.

**Figure 99: Downlink Performance, Different ISDs<sup>232</sup>**

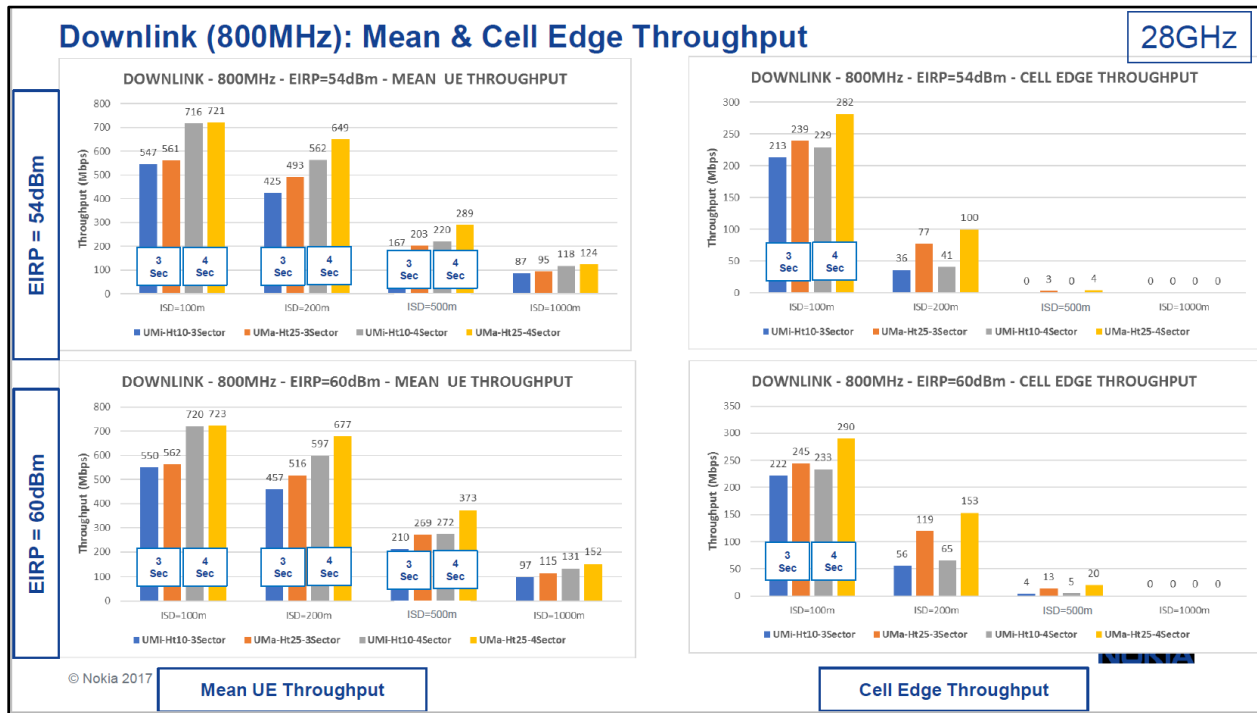

Other simulations conclude that a minimum performance of 100 Mbps at the cell-edge, a 5G objective, is possible at ISDs up to 200 meters, with and without foliage.<sup>233</sup>

The following three figures are from another simulation study by Ericsson, this one for fixed-wireless access, with the following key assumptions: 350-meter ISD, 96-antenna base stations, 200 MHz radio channels, 57% allocated to downlink, 1000 homes per sq. km, 25% of homes using 4K UHD video service at 15 Mbps, building heights of 4 to 10 meters, and trees from 5 to 15 meters.

Figure 100 shows the throughputs available across the coverage area, with many locations able to receive close to 1 Gbps.

<sup>232</sup> Nokia contribution.

<sup>233</sup> Frederick W. Vook, Eugene Visotsky, Timothy A. Thomas, and Amitava Ghosh, Nokia Bell Labs, *Performance Characteristics of 5G mmWave Wireless-to-the-Home*. <http://ieeexplore.ieee.org/document/7869558/>.

**Figure 100: Throughput Map of Suburban Area at Low Load<sup>234</sup>**

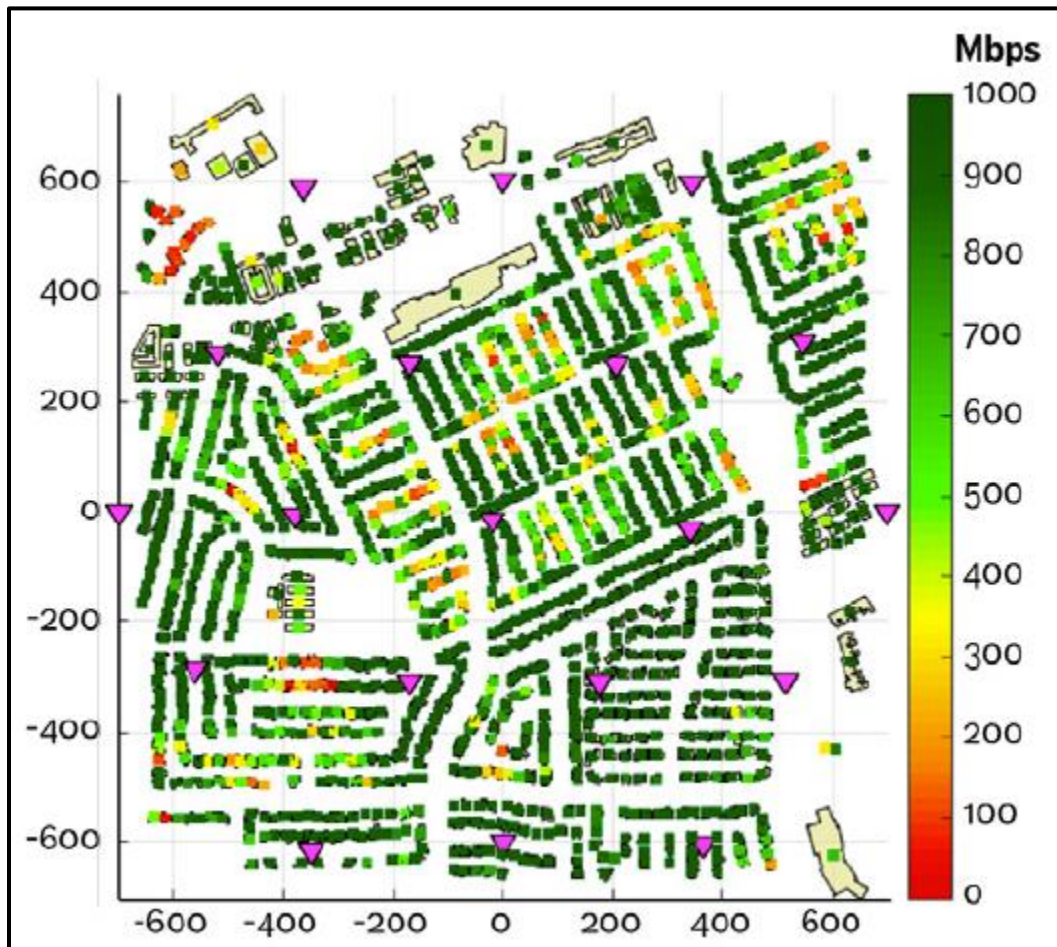

Figure 101 shows the proportion of users that can obtain 15 Mbps and 100 Mbps service relative to monthly traffic volume. Note that the system supports thousands of GBs of service per subscriber per month.

---

<sup>234</sup> Ericsson contribution, Ericsson Technical Review, *5G and Fixed Wireless Access*, 2016.  
<https://www.ericsson.com/assets/local/publications/ericsson-technology-review/docs/2016/etr-5g-and-fixed-wireless-access.pdf>.

**Figure 101: Proportion of Satisfied Users Relative to Monthly Usage<sup>235</sup>**

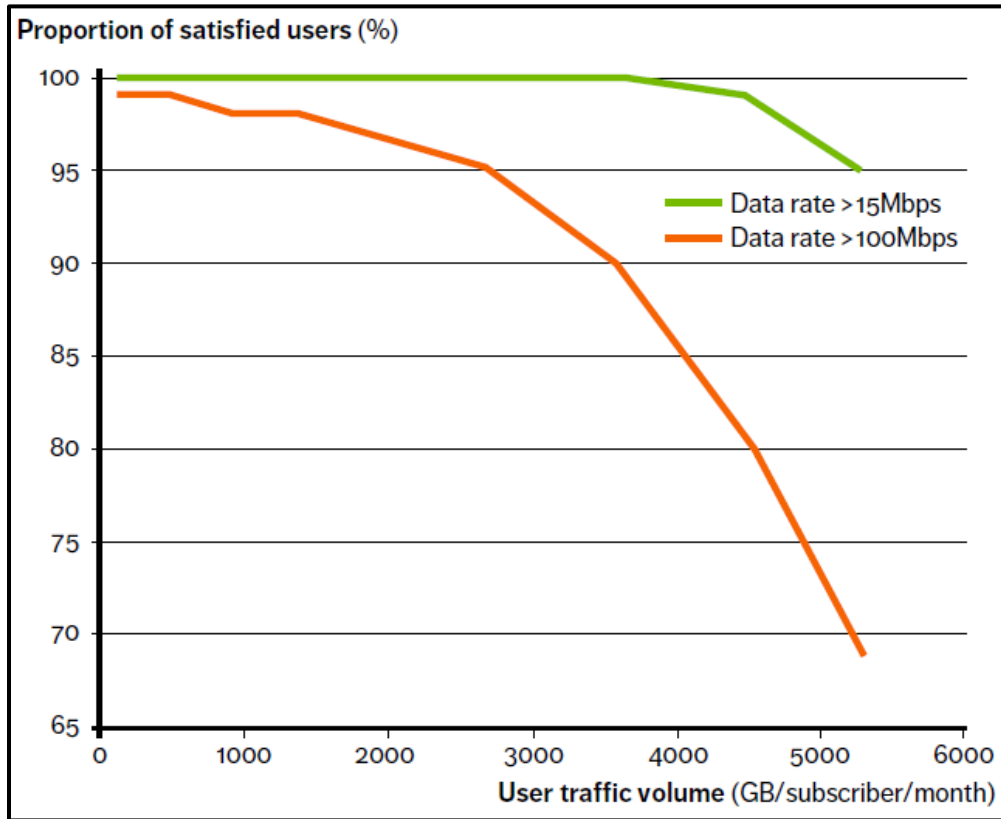
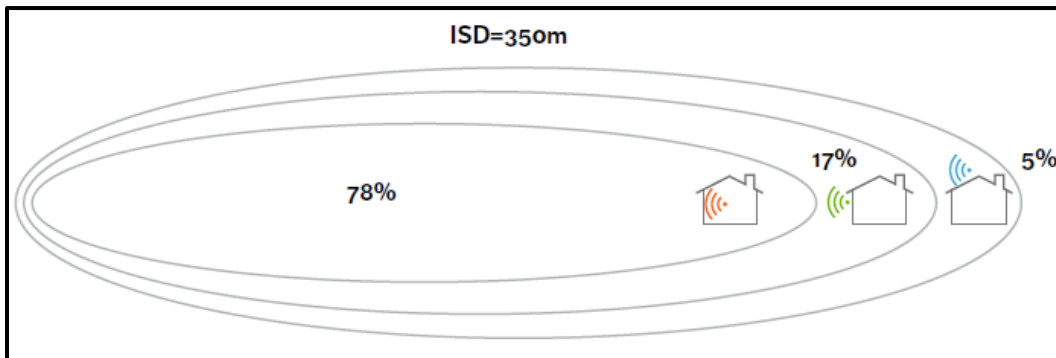

Figure 102 shows that an ISD of 350 can be used with a combination of indoor, wall-mounted, and rooftop antennas. A large percentage of users (78%) can use indoor antennas, facilitating deployment.

**Figure 102: Breakdown of Indoor, Wall-Mounted, and Rooftop Antennas<sup>236</sup>**



<sup>235</sup> Ibid.

<sup>236</sup> Ibid.

The simulation study shows that 5G fixed wireless access deployments using a larger ISD of 350 meters, translating to 11 base stations per square kilometer, can provide competitive broadband service.

In this environment, handsets with 5G mmWave capability will also be able to access the networks. However the antennas they use may not be as effective as the fixed-wireless equipment, so handsets may need to fall back to 4G, depending on their precise locations. For this reason, the dual connectivity being planned for 5G will play an important role.

Figure 103 shows another simulation study, this one from Intel, using the following assumptions: 28 GHz operation, 2:1 DL:UL ratio, 25% control overhead, 10 bps/Hz maximum downlink spectral efficiency, CPEs placed either north or south side of house and one with best SNR chosen, and indoor CPE equipment with 30dB outdoor-to-indoor penetration loss. Scenario 1 is 60 access points per sq. km. Scenario 2 is 120 access points per sq. km. (Base grid of 40 houses in a 250x200m area with four rows of 10 houses per row, APs placed along streets and alleys, single-family homes, 4 sectors per AP, and 4.5-meter pole height).

**Figure 103: 5G Fixed Wireless Simulation with Different Loading and Densities<sup>237</sup>**

DL	Scenario 1 (3 APs per 40 homes)				Scenario 2 (6 APs per 40 homes)			
	10% loading		50% loading		10% loading		50% loading	
	Cell-edge (Mbps)	Average (Mbps)	Cell-edge (Mbps)	Average (Mbps)	Cell-edge (Mbps)	Average (Mbps)	Cell-edge (Mbps)	Average (Mbps)
100 MHz, 64x8	5	200	4	160	50	290	45	230
100 MHz, 128x16	22	280	20	210	150	370	145	275
400 MHz, 128x16	88	1,120	80	840	600	1,480	580	1,100

UL	Scenario 1 (3 APs per 40 homes)				Scenario 2 (6 APs per 40 homes)			
	10% loading		50% loading		10% loading		50% loading	
	Cell-edge (Mbps)	Average (Mbps)	Cell-edge (Mbps)	Average (Mbps)	Cell-edge (Mbps)	Average (Mbps)	Cell-edge (Mbps)	Average (Mbps)
100MHz, 16x64	2	85	1	75	35	120	30	100
100MHz, 16x128	4	95	2	80	50	140	40	110
100MHz, 32x64	7	100	4	85	70	150	60	115

Using 400 MHz and six access points per 40 homes, and 50% loading, the average throughput was more than 1 Gbps.

### Quality of Service

5G employs a quality-of-service architecture. Similar to LTE, 5G uses QoS Class Identifiers, called 5G QoS Identifiers (5QIs), to manage parameters such as whether bit rates are guaranteed, guaranteed bit rate, priority level, packet delay budget, and packet error rate. 5G, however, adds a parameter called default maximum data burst volume, which is the maximum amount of data the network is required to deliver within a period of the packet delay budget. The section "Network Slicing" in the main body of this paper discusses how 5G networks will take advantage of QoS.

Release 15 of 3GPP specifications define the 5QIs as follows:

<sup>237</sup> Intel contribution.

**Table 27: 5QI to QoS Characteristics Mapping<sup>238</sup>**

5QI Value	Resource Type	Default Priority Level	Packet Delay Budget	Packet Error Rate	Default Maximum Data Burst Volume (NOTE 2)	Default Averaging Window	Example Services	
10	Delay Critical GBR	11	5 ms	10 <sup>-5</sup>	160 B	TBD	Remote control (see TS 22.261 [2])	
11 NOTE 4		12	10 ms NOTE 5	10 <sup>-5</sup>	320 B	TBD	Intelligent transport systems	
12		13	20 ms	10 <sup>-5</sup>	640 B	TBD		
16 NOTE 4		18	10 ms	10 <sup>-4</sup>	255 B	TBD	Discrete Automation	
17 NOTE 4		19	10 ms	10 <sup>-4</sup>	1358 B NOTE 3	TBD	Discrete Automation	
1	GBR NOTE 1	20	100 ms	10 <sup>-2</sup>	N/A	TBD	Conversational Voice	
2		40	150 ms	10 <sup>-3</sup>	N/A	TBD	Conversational Video (Live Streaming)	
3		30	50 ms	10 <sup>-3</sup>	N/A	TBD	Real Time Gaming, V2X messages Electricity distribution – medium voltage, Process automation - monitoring	
4		50	300 ms	10 <sup>-6</sup>	N/A	TBD	Non-Conversational Video (Buffered Streaming)	
65		7	75 ms	10 <sup>-2</sup>	N/A	TBD	Mission Critical user plane Push To Talk voice (e.g., MCPTT)	
66		20	100 ms	10 <sup>-2</sup>	N/A	TBD	Non-Mission-Critical user plane Push To Talk voice	
75		25	50 ms	10 <sup>-2</sup>	N/A	TBD	V2X messages	
E NOTE 4		18	10 ms	10 <sup>-4</sup>	255 B	TBD	Discrete Automation	
F NOTE 4		19	10 ms	10 <sup>-4</sup>	1358 B NOTE 3	TBD	Discrete Automation	
5		Non-GBR NOTE 1	10	100 ms	10 <sup>-6</sup>	N/A	N/A	IMS Signalling
6			60	300 ms	10 <sup>-6</sup>	N/A	N/A	Video (Buffered Streaming) TCP-based (e.g., www, e-mail, chat, ftp, p2p file sharing, progressive video, etc.)
7			70	100 ms	10 <sup>-3</sup>	N/A	N/A	Voice, Video (Live Streaming) Interactive Gaming
8			80	300 ms	10 <sup>-6</sup>	N/A	N/A	Video (Buffered Streaming) TCP-based (e.g., www, e-mail, chat, ftp, p2p file
9	90				N/A	N/A	sharing, progressive video, etc.)	
69	5		60 ms	10 <sup>-6</sup>	N/A	N/A	Mission Critical delay sensitive signalling (e.g., MC-PTT signalling)	
70	55		200 ms	10 <sup>-6</sup>	N/A	N/A	Mission Critical Data (e.g. example services are the same as QCI 6/8/9)	
79			65	50 ms	10 <sup>-2</sup>	N/A	N/A	V2X messages
80			66	10 ms	10 <sup>-6</sup>	N/A	N/A	Low Latency eMBB applications Augmented Reality
NOTE 1: a packet which is delayed more than PDB is not counted as lost, thus not included in the PER.								
NOTE 2: it is required that default Maximum Data Burst Volume is supported by a PLMN supporting the related 5QIs.								
NOTE 3: This Maximum Burst Size value is intended to avoid IP fragmentation on an IPv6 based, IPsec protected, GTP tunnel to the 5G-AN node.								
NOTE 4: A delay of 1 ms for the delay between a UPF terminating N6 and a 5G-AN should be subtracted from a given PDB to derive the packet delay budget that applies to the radio interface.								
NOTE 5: The jitter for this service is assumed to be 20 msec as per TS 22.261 [2].								

## ***Spectrum Bands for 4G and 5G***

3GPP technologies operate in a wide range of radio bands. As new spectrum becomes available, 3GPP updates its specifications for these bands. Although the support of a new frequency band may be introduced in a particular release, 3GPP specifies ways to implement devices and infrastructure operating on any frequency band, according to releases previous to the introduction of that particular frequency band. For example, although band 5 (US Cellular Band) was introduced in Release 6, the first devices operating on this band were compliant with the release 5 of the standard.

The following tables show the 3GPP-defined bands for different technologies, listed in the order of 5G, 4G, and 3G.

Table 28 shows 5G NR bands in frequency range 1, which spans 450 – 6000 MHz.

---

<sup>238</sup> 3GPP, System Architecture for the 5G System; Stage 2, (Release 15), 3GPP TS 23.501 V15.1.0, (2018-03), Table 5.7.4-1.

**Table 28: 5G NR Bands in Frequency Range 1<sup>239</sup>**

NR operating band	Uplink (UL) operating band BS receive / UE transmit	Downlink (DL) operating band BS transmit / UE receive	Duplex Mode
	$F_{UL,low} - F_{UL,high}$	$F_{DL,low} - F_{DL,high}$	
n1	1920 MHz – 1980 MHz	2110 MHz – 2170 MHz	FDD
n2	1850 MHz – 1910 MHz	1930 MHz – 1990 MHz	FDD
n3	1710 MHz – 1785 MHz	1805 MHz – 1880 MHz	FDD
n5	824 MHz – 849 MHz	869 MHz – 894 MHz	FDD
n7	2500 MHz – 2570 MHz	2620 MHz – 2690 MHz	FDD
n8	880 MHz – 915 MHz	925 MHz – 960 MHz	FDD
n12	699 MHz – 716 MHz	729 MHz – 746 MHz	FDD
n14	788 MHz – 798 MHz	758 MHz – 768 MHz	FDD
n18	815 MHz – 830 MHz	860 MHz – 875 MHz	FDD
n20	832 MHz – 862 MHz	791 MHz – 821 MHz	FDD
n25	1850 MHz – 1915 MHz	1930 MHz – 1995 MHz	FDD
n26	814 MHz – 849 MHz	859 MHz – 894 MHz	FDD
n28	703 MHz – 748 MHz	758 MHz – 803 MHz	FDD
n29	N/A	717 MHz – 728 MHz	SDL
n30 <sup>3</sup>	2305 MHz – 2315 MHz	2350 MHz – 2360 MHz	FDD
n34	2010 MHz – 2025 MHz	2010 MHz – 2025 MHz	TDD
n38	2570 MHz – 2620 MHz	2570 MHz – 2620 MHz	TDD
n39	1880 MHz – 1920 MHz	1880 MHz – 1920 MHz	TDD
n40	2300 MHz – 2400 MHz	2300 MHz – 2400 MHz	TDD
n41	2496 MHz – 2690 MHz	2496 MHz – 2690 MHz	TDD
n48	3550 MHz – 3700 MHz	3550 MHz – 3700 MHz	TDD
n50	1432 MHz – 1517 MHz	1432 MHz – 1517 MHz	TDD <sup>1</sup>
n51	1427 MHz – 1432 MHz	1427 MHz – 1432 MHz	TDD
n53	2483.5 MHz – 2495 MHz	2483.5 MHz – 2495 MHz	TDD
n65	1920 MHz – 2010 MHz	2110 MHz – 2200 MHz	FDD <sup>4</sup>
n66	1710 MHz – 1780 MHz	2110 MHz – 2200 MHz	FDD
n70	1695 MHz – 1710 MHz	1995 MHz – 2020 MHz	FDD
n71	663 MHz – 698 MHz	617 MHz – 652 MHz	FDD
n74	1427 MHz – 1470 MHz	1475 MHz – 1518 MHz	FDD
n75	N/A	1432 MHz – 1517 MHz	SDL
n76	N/A	1427 MHz – 1432 MHz	SDL
n77	3300 MHz – 4200 MHz	3300 MHz – 4200 MHz	TDD
n78	3300 MHz – 3800 MHz	3300 MHz – 3800 MHz	TDD
n79	4400 MHz – 5000 MHz	4400 MHz – 5000 MHz	TDD
n80	1710 MHz – 1785 MHz	N/A	SUL
n81	880 MHz – 915 MHz	N/A	SUL
n82	832 MHz – 862 MHz	N/A	SUL
n83	703 MHz – 748 MHz	N/A	SUL
n84	1920 MHz – 1980 MHz	N/A	SUL
n86	1710 MHz – 1780 MHz	N/A	SUL
n89	824 MHz – 849 MHz	N/A	SUL
n90	2496 MHz – 2690 MHz	2496 MHz – 2690 MHz	TDD <sup>5</sup>
n91	832 MHz – 862 MHz	1427 MHz – 1432 MHz	FDD <sup>9</sup>
n92	832 MHz – 862 MHz	1432 MHz – 1517 MHz	FDD <sup>9</sup>
n93	880 MHz – 915 MHz	1427 MHz – 1432 MHz	FDD <sup>9</sup>
n94	880 MHz – 915 MHz	1432 MHz – 1517 MHz	FDD <sup>9</sup>
n95 <sup>8</sup>	2010 MHz – 2025 MHz	N/A	SUL

Table 29 shows initial 5G NR bands in frequency range 2, which spans 24250 – 52600 MHz.

<sup>239</sup> 3GPP, *User Equipment (UE) radio transmission and reception; Part 1: Range 1 Standalone (Release 16)*, 3GPP TS 38.101-1, V16.3.0, Mar. 2020.



**Table 29: 5G NR Bands in Frequency Range 2<sup>240</sup>**

Operating Band	Uplink (UL) operating band BS receive UE transmit	Downlink (DL) operating band BS transmit UE receive	Duplex Mode
	$F_{UL,low} - F_{UL,high}$	$F_{DL,low} - F_{DL,high}$	
n257	26500 MHz – 29500 MHz	26500 MHz – 29500 MHz	TDD
n258	24250 MHz – 27500 MHz	24250 MHz – 27500 MHz	TDD
n260	37000 MHz – 40000 MHz	37000 MHz – 40000 MHz	TDD
n261	27500 MHz – 28350 MHz	27500 MHz – 28350 MHz	TDD

Table 30 details the LTE Frequency Division Duplex (FDD) and TDD bands.

---

<sup>240</sup> 3GPP, User Equipment (UE) radio transmission and reception; Part 2: Range 2 Standalone (Release 16), 3GPP TS 38.101-2, V16.3.1, Mar. 2020.

**Table 30: LTE FDD and TDD bands<sup>241</sup>**

E-UTRA Operating Band	Uplink (UL) operating band BS receive UE transmit	Downlink (DL) operating band BS transmit UE receive	Duplex Mode
	<u>F<sub>UL,low</sub></u> – <u>F<sub>UL,high</sub></u>	<u>F<sub>DL,low</sub></u> – <u>F<sub>DL,high</sub></u>	
1	1920 MHz – 1980 MHz	2110 MHz – 2170 MHz	FDD
2	1850 MHz – 1910 MHz	1930 MHz – 1990 MHz	FDD
3	1710 MHz – 1785 MHz	1805 MHz – 1880 MHz	FDD
4	1710 MHz – 1755 MHz	2110 MHz – 2155 MHz	FDD
5	824 MHz – 849 MHz	869 MHz – 894MHz	FDD
6 (NOTE 1)	830 MHz – <u>840 MHz</u>	875 MHz – 885 MHz	FDD
7	2500 MHz – 2570 MHz	2620 MHz – 2690 MHz	FDD
8	880 MHz – 915 MHz	925 MHz – 960 MHz	FDD
9	1749.9 MHz – 1784.9 MHz	1844.9 MHz – 1879.9 MHz	FDD
10	1710 MHz – 1770 MHz	2110 MHz – 2170 MHz	FDD
11	1427.9 MHz – 1447.9 MHz	1475.9 MHz – 1495.9 MHz	FDD
12	699 MHz – 716 MHz	729 MHz – 746 MHz	FDD
13	777 MHz – 787 MHz	746 MHz – 756 MHz	FDD
14	788 MHz – 798 MHz	758 MHz – 768 MHz	FDD
15	Reserved	Reserved	FDD
16	Reserved	Reserved	FDD
17	704 MHz – 716 MHz	734 MHz – 746 MHz	FDD
18	815 MHz – 830 MHz	860 MHz – 875 MHz	FDD
19	830 MHz – 845 MHz	875 MHz – 890 MHz	FDD
20	832 MHz – 862 MHz	791 MHz – 821 MHz	FDD
21	1447.9 MHz – 1462.9 MHz	1495.9 MHz – 1510.9 MHz	FDD
22	3410 MHz – 3490 MHz	3510 MHz – 3590 MHz	FDD
23 <sup>1</sup>	2000 MHz – 2020 MHz	2180 MHz – 2200 MHz	FDD
24	1626.5 MHz – 1660.5 MHz	1525 MHz – 1559 MHz	FDD
25	1850 MHz – <u>1915 MHz</u>	1930 MHz – 1995 MHz	FDD
26	814 MHz – 849 MHz	859 MHz – 894 MHz	FDD
27	807 MHz – 824 MHz	852 MHz – 869 MHz	FDD
28	703 MHz – 748 MHz	758 MHz – 803 MHz	FDD
29	N/A	717 MHz – 728 MHz	FDD (NOTE 2)
30	2305 MHz – 2315 MHz	2350 MHz – 2360 MHz	FDD
31	452.5 MHz – 457.5 MHz	462.5 MHz – 467.5 MHz	FDD
32	N/A	1452 MHz – 1496 MHz	FDD (NOTE 2)
33	1900 MHz – 1920 MHz	1900 MHz – 1920 MHz	TDD
34	2010 MHz – 2025 MHz	2010 MHz – 2025 MHz	TDD
35	1850 MHz – 1910 MHz	1850 MHz – 1910 MHz	TDD
36	1930 MHz – 1990 MHz	1930 MHz – 1990 MHz	TDD
37	1910 MHz – 1930 MHz	1910 MHz – 1930 MHz	TDD
38	2570 MHz – 2620 MHz	2570 MHz – 2620 MHz	TDD
39	1880 MHz – 1920 MHz	1880 MHz – 1920 MHz	TDD
40	2300 MHz – 2400 MHz	2300 MHz – 2400 MHz	TDD
41	2496 MHz – 2690 MHz	2496 MHz – 2690 MHz	TDD
42	3400 MHz – 3600 MHz	3400 MHz – 3600 MHz	TDD
43	3600 MHz – 3800 MHz	3600 MHz – 3800 MHz	TDD
44	703 MHz – 803 MHz	703 MHz – 803 MHz	TDD
45	1447 MHz – 1467 MHz	1447 MHz – 1467 MHz	TDD
46	5150 MHz – 5925 MHz	5150 MHz – 5925 MHz	TDD (NOTE 3, NOTE 4)
47	5855 MHz – 5925 MHz	5855 MHz – 5925 MHz	TDD
48	3550 MHz – 3700 MHz	3550 MHz – 3700 MHz	TDD
49	3550 MHz – 3700 MHz	3550 MHz – 3700 MHz	TDD (NOTE 8)
50	1432 MHz – 1517 MHz	1432 MHz – 1517 MHz	TDD
51	1427 MHz – 1432 MHz	1427 MHz – 1432 MHz	TDD

52	3300 MHz - 3400 MHz	3300 MHz - 3400 MHz	TDD
53	2483.5 MHz - 2495 MHz	2483.5 MHz - 2495 MHz	TDD
65	1920 MHz - 2010 MHz	2110 MHz - 2200 MHz	FDD
66	1710 MHz - 1780 MHz	2110 MHz - 2200 MHz	FDD (NOTE 5)
67	N/A	738 MHz - 758 MHz	FDD (NOTE 2)
68	698 MHz - 728 MHz	753 MHz - 783 MHz	FDD
69	N/A	2570 MHz - 2620 MHz	FDD (NOTE 2)
70	1695 MHz - 1710 MHz	1995 MHz - 2020 MHz	FDD <sup>6</sup>
71	663 MHz - 698 MHz	617 MHz - 652 MHz	FDD
72	451 MHz - 456 MHz	461 MHz - 466 MHz	FDD
73	450 MHz - 455 MHz	460 MHz - 465 MHz	FDD
74	1427 MHz - 1470 MHz	1475 MHz - 1518 MHz	FDD
75	N/A	1432 MHz - 1517 MHz	FDD (NOTE 2)
76	N/A	1427 MHz - 1432 MHz	FDD (NOTE 2)
85	698 MHz - 716 MHz	728 MHz - 746 MHz	FDD
87	410 MHz - 415 MHz	420 MHz - 425 MHz	FDD
88	412 MHz - 417 MHz	422 MHz - 427 MHz	FDD
<p>NOTE 1: Band 6, 23 are not applicable.</p> <p>NOTE 2: Restricted to E-UTRA operation when carrier aggregation is configured. The downlink operating band is paired with the uplink operating band (external) of the carrier aggregation configuration that is supporting the configured Pcell.</p> <p>NOTE 3: This band is an unlicensed band restricted to licensed-assisted operation using Frame Structure Type 3.</p> <p>NOTE 4: Band 46 is divided into four sub-bands as in Table 5.5-1A.</p> <p>NOTE 5: The range 2180 - 2200 MHz of the DL operating band is restricted to E-UTRA operation when carrier aggregation is configured.</p> <p>NOTE 6: The range 2010-2020 MHz of the DL operating band is restricted to E-UTRA operation when carrier aggregation is <u>configured</u> and TX-RX separation is 300 MHz. The range 2005-2020 MHz of the DL operating band is restricted to E-UTRA operation when carrier aggregation is <u>configured</u> and TX-RX separation is 295 MHz.</p> <p>NOTE 7: Void</p> <p>NOTE 8: This band is restricted to licensed-assisted operation using Frame Structure Type 3.</p>			

## 3GPP Releases to Release 14

- ❑ **Release 99:** Completed. First deployable version of UMTS. Enhancements to GSM data (EDGE). Provides support for GSM/EDGE/GPRS/WCDMA radio-access networks.
- ❑ **Release 4:** Completed. Multimedia messaging support. First steps toward using IP transport in the core network.
- ❑ **Release 5:** Completed. HSDPA. First phase of Internet Protocol Multimedia Subsystem (IMS). Full ability to use IP-based transport instead of just Asynchronous Transfer Mode (ATM) in the core network.
- ❑ **Release 6:** Completed. HSUPA. Enhanced multimedia support through Multimedia Broadcast/Multicast Services (MBMS). Performance specifications for advanced receivers. Wireless Local Area Network (WLAN) integration option. IMS enhancements. Initial VoIP capability.
- ❑ **Release 7:** Completed. Provides enhanced GSM data functionality with Evolved EDGE. Specifies HSPA+, which includes higher-order modulation and MIMO. Performance enhancements, improved spectral efficiency, increased capacity, and better resistance to interference. Continuous Packet Connectivity (CPC) enables efficient “always-on”

<sup>241</sup> 3GPP, *Evolved Universal Terrestrial Radio Access (E-UTRA); Base Station (BS) radio transmission and reception (Release 16)*, TS 36.104, V16.5.0, Mar. 2020.

service and enhanced uplink UL VoIP capacity, as well as reductions in call set-up delay for Push-to-Talk Over Cellular (PoC). Radio enhancements to HSPA include 64 Quadrature Amplitude Modulation (QAM) in the downlink and 16 QAM in the uplink. Also includes optimization of MBMS capabilities through the multicast/broadcast, single frequency network (MBSFN) function.

- ❑ **Release 8:** Completed. Comprises further HSPA Evolution features such as simultaneous use of MIMO and 64 QAM. Includes dual-carrier HSDPA (DC-HSDPA) wherein two downlink carriers can be combined for a doubling of throughput performance. Specifies OFDMA-based 3GPP LTE. Defines EPC and EPS.
- ❑ **Release 9:** Completed. HSPA and LTE enhancements including HSPA dual-carrier downlink operation in combination with MIMO, Multimedia Broadcast Multicast Services (MBMS), HSDPA dual-band operation, HSPA dual-carrier uplink operation, EPC enhancements, femtocell support, support for regulatory features such as emergency user equipment positioning and Commercial Mobile Alert System (CMAS), and evolution of IMS architecture.
- ❑ **Release 10:** Completed. Specifies LTE-Advanced that meets the requirements set by ITU's IMT-Advanced project. Key features include carrier aggregation, multi-antenna enhancements such as enhanced downlink eight-branch MIMO and uplink MIMO, relays, enhanced LTE Self-Organizing Network capability, Evolved Multimedia Broadcast Multicast Services (eMBMS), HetNet enhancements that include eICIC, Local IP Packet Access, and new frequency bands. For HSPA, includes quad-carrier operation and additional MIMO options. Also includes femtocell enhancements, optimizations for M2M communications, and local IP traffic offload.
- ❑ **Release 11:** Completed. For LTE, emphasizes Coordinated Multi Point (CoMP), carrier-aggregation enhancements, devices with interference cancellation, development of the Enhanced Physical Downlink Control Channel (EPDCCH), and further enhanced eICIC including devices with CRS (Cell-specific Reference Signal) interference cancellation. The release includes further DL and UL MIMO enhancements for LTE. For HSPA, provides eight-carrier on the downlink, uplink enhancements to improve latency, dual-antenna beamforming and MIMO, CELL Forward Access Channel (FACH) state enhancement for smartphone-type traffic, four-branch MIMO enhancements and transmissions for HSDPA, 64 QAM in the uplink, downlink multipoint transmission, and noncontiguous HSDPA carrier aggregation. Wi-Fi integration is promoted through S2a Mobility over GPRS Tunneling Protocol (SaMOG). An additional architectural element called "Machine-Type Communications Interworking Function" (MTC-IWF) will more flexibly support machine-to-machine communications.
- ❑ **Release 12:** Completed. Enhancements include improved small cells/HetNets for LTE, LTE multi-antenna/site technologies (including Active Antenna Systems), Dual Connectivity, 256 QAM modulation option, further CoMP/MIMO enhancements, enhancements for interworking with Wi-Fi, enhancements for MTC, SON, support for emergency and public safety, Minimization of Drive Tests (MDT), advanced receivers, device-to-device communication (also referred to as Proximity Services), group communication enablers in LTE, addition of Web Real Time Communication (WebRTC) to IMS, energy efficiency, more flexible carrier aggregation, dynamic adaptation of uplink-downlink ratios in TDD mode, further enhancements for HSPA+, small cells/HetNets, Scalable-UMTS, and FDD-TDD carrier aggregation.
- ❑ **Release 13:** Completed. LTE features include Active Antenna Systems (AAS) with support for as many as 16 antenna elements (full-dimension MIMO) and beamforming,

Network-Assisted Interference Cancellation and Suppression (NAICS), radio-access network sharing, carrier aggregation supporting 32 component carriers,<sup>242</sup> carrier aggregation of up to four carriers on the downlink and two carriers on the uplink, LAA for operation in unlicensed bands, LTE Wi-Fi Aggregation including LWIP, RCLWI, isolated operation and mission-critical voice communications for public safety, application-specific congestion management, User-Plane Congestion Management, enhancement to WebRTC interoperability, architecture enhancement for dedicated core networks, enhancement to proximity-based services, Mission-Critical Push-to-Talk, group communications, CoMP enhancements, small cell enhancements, machine-type communications enhancements including NB-IoT and Extended Coverage GSM (EC-GSM), VoLTE enhancements, SON enhancements, shared network enhancements, indoor positioning based on WLAN access points, Bluetooth beacons and barometric pressure, and enhanced circuit-switched fallback. HSPA+ features include support for dual-band uplink carrier aggregation.

- **Release 14:** Completed June 2017. Features include uplink operation for LAA (enhanced LAA), full-dimension MIMO enhanced with up to 32 antenna elements, dual-connectivity of licensed and unlicensed carriers across non-collocated nodes, vehicle-to-vehicle and vehicle-to-infrastructure (V2X) communications built on Release 12 Proximity Services, shared LTE broadcast in which different operators broadcast the same content on the same frequency, non-IP operation for IoT, Downlink Multi-user Superposition Transmission (MUST), enhanced LWA, VoLTE enhancements, LWIP/LWA enhancements, eMBMS enhancements, NB-IoT enhancements, and LTE latency reduction.

For a detailed explanation of features in subsequent 3GPP releases, refer to the main part of the paper, sections: "5G Phase One (Release 15)," "5G Phase Two (Release 16)," and "5G Release 17."

## ***Data Throughput Comparison***

Data throughput is an important metric for quantifying network throughput performance. Unfortunately, the ways in which various organizations quote throughputs vary tremendously, often resulting in misleading claims. The intent of this paper is to realistically represent the capabilities of these technologies.

One method of representing a technology's throughput is what people call "peak throughput" or "peak network speed," which refers to the fastest possible transmission speed over the radio link and is generally based on the highest-order modulation available and the least amount of coding (error correction) overhead. Peak network speed is also usually quoted at layer 2 of the radio link. Because of protocol overhead, actual application throughput may be up to 10% lower than this layer-2 value.

Another method is to disclose throughputs actually measured in deployed networks with applications such as File Transfer Protocol (FTP) under favorable conditions, which assume light network load (as low as one active data user in the cell sector) and favorable signal propagation. This number is useful because it demonstrates the high-end, actual capability of the technology in current deployments, referred to in this paper as the "peak user rate." Average rates are lower than this peak rate and are difficult to predict because they

---

<sup>242</sup> This level of aggregation refers to signaling capabilities. The number of carriers that can be combined in an actual deployment is smaller and depends on RAN co-existence studies. Refer to the appendix section on "Carrier Aggregation" for additional details.

depend on a multitude of operational and network factors. Except when the network is congested, however, the majority of users should experience throughput rates higher than one-half of the peak achievable rate.

Some operators, primarily in the United States, also quote typical throughput rates, which are based on throughput tests the operators have done across their operating networks and incorporate a higher level of network load. Although the operators do not disclose the precise methodologies they use to establish these figures, the values provide a good indication of what users can realistically expect.

Table 31 presents the technologies in terms of peak network throughput rates, peak user rates (under favorable conditions), and typical rates. It omits values that are not yet known, such as for future technologies.

The projected typical rates for HSPA+ and LTE show a wide range because these technologies exploit favorable radio conditions to achieve high throughput rates, but under poor radio conditions, throughput rates are lower.

**Table 31: Throughput Performance of Different Wireless Technologies  
(Blue Indicates Theoretical Peak Rates, Green Typical)**

	Downlink		Uplink	
	Peak Network Speed	Peak and/or Typical User Rate	Peak Network Speed	Peak and/or Typical User Rate
<b>5G in mmWave, early versions<sup>243</sup></b>	5 Gbps	500 Mbps	2 Gbps	250 Mbps
<b>5G in mmWave, later versions<sup>244</sup></b>	50 Gbps	5 Gbps	25 Gbps	2 Gbps
<b>LTE (2X2 MIMO, 10+10 MHz, DL 64 QAM, UL 16 QAM)</b>	70 Mbps	6.5 to 26.3 Mbps <sup>245</sup>	35 Mbps <sup>246</sup>	6.0 to 13.0 Mbps
<b>LTE-Advanced (2X2 or 4X4 MIMO, 20+20 MHz or 40+20 MHz with Carrier Aggregation [CA], DL 64 QAM, UL 16 QAM)</b>	300 Mbps	N/A	71 Mbps <sup>247</sup>	N/A
<b>LTE Advanced (4X4 MIMO, 60+20MHz, CA, 256 QAM DL, 64 QAM UL)</b>	600 Mbps		150 Mbps	
<b>LTE Advanced (4X4 MIMO, 80+20 MHz, CA, 256 QAM DL, 64 QAM UL)</b>	> 1 Gbps		150 Mbps	

<sup>243</sup> Assumes 200 MHz radio channel, 2:1 TDD. Throughput rates would double using 400 MHz.

<sup>244</sup> Assumes greater radio bandwidth.

<sup>245</sup> 5G Americas member company analysis for downlink and uplink. Assumes single user with 50% load in other sectors. AT&T and Verizon are quoting typical user rates of 5-12 Mbps on the downlink and 2-5 Mbps on the uplink for their networks. See additional LTE throughput information in the section below, "LTE Throughput."

<sup>246</sup> Assumes 64 QAM. Otherwise 22 Mbps with 16 QAM.

<sup>247</sup> Assumes 64 QAM. Otherwise 45 Mbps with 16 QAM.

	Downlink		Uplink	
	Peak Network Speed	Peak and/or Typical User Rate	Peak Network Speed	Peak and/or Typical User Rate
<b>LTE Advanced (8X8 MIMO, 20+20 MHz, DL 64 QAM, UL 64 QAM)</b>	1.2 Gbps	N/A	568 Mbps	N/A
<b>LTE Advanced, 100 MHz + 100 MHz</b>	3 Gbps		1.5 Gbps	
<b>LTE Advanced 32 Carriers</b>	>> 3 Gbps			
<b>EDGE (type 2 MS)</b>	473.6 Kbps	Not Applicable (N/A)	473.6 Kbps	N/A
<b>EDGE (type 1 MS) (Practical Terminal)</b>	236.8 Kbps	200 Kbps peak 160 to 200 Kbps typical <sup>248</sup>	236.8 Kbps	200 Kbps peak 80 to 160 Kbps typical <sup>249</sup>
<b>HSDPA Initial Devices (2006)</b>	1.8 Mbps	> 1 Mbps peak	384 Kbps	350 Kbps peak
<b>HSDPA</b>	14.4 Mbps	N/A	384 Kbps	N/A
<b>HSPA<sup>250</sup> Initial Implementation</b>	7.2 Mbps	> 5 Mbps peak 700 Kbps to 1.7 Mbps typical <sup>251</sup>	2 Mbps	> 1.5 Mbps peak 500 Kbps to 1.2 Mbps typical

<sup>248</sup> Assumes four-to-five downlink timeslot devices (each timeslot capable of 40 Kbps).

<sup>249</sup> Assumes two-to-four uplink timeslot devices (each timeslot capable of 40 Kbps).

<sup>250</sup> High Speed Packet Access (HSPA) consists of systems supporting both High Speed Downlink Packet Access (HSDPA) and High Speed Uplink Packet Access (HSUPA).

<sup>251</sup> Typical downlink and uplink throughput rates based on AT&T press release, Jun. 4, 2008



	Downlink		Uplink	
	Peak Network Speed	Peak and/or Typical User Rate	Peak Network Speed	Peak and/or Typical User Rate
<b>HSPA</b>	14.4 Mbps	N/A	5.76 Mbps	N/A
<b>HSPA+ (DL 64 QAM, UL 16 QAM, 5+5 MHz)</b>	21.6 Mbps	1.9 Mbps to 8.8 Mbps typical <sup>252</sup>	11.5 Mbps	1 Mbps to 4 Mbps typical
<b>HSPA+ (2X2 MIMO, DL 16 QAM, UL 16 QAM, 5+5 MHz)</b>	28 Mbps	N/A	11.5 Mbps	N/A
<b>HSPA+ (2X2 MIMO, DL 64 QAM, UL 16 QAM, 5+5 MHz)</b>	42 Mbps	N/A	11.5 Mbps	N/A
<b>HSPA+ (DL 64 QAM, UL 16 QAM, Dual Carrier, 10+5 MHz)</b>	42 Mbps	Approximate doubling of 5+5 MHz rates - 3.8 to 17.6 Mbps.	11.5 Mbps	1 Mbps to 4 Mbps typical
<b>HSPA+ (2X2 MIMO DL, DL 64 QAM, UL 16 QAM, Dual Carrier, 10+10 MHz)</b>	84 Mbps	N/A	23 Mbps	N/A
<b>HSPA+ (2X2 MIMO DL, DL 64 QAM, UL 16 QAM, Quad-Carrier,<sup>253</sup> 20+10 MHz)</b>	168 Mbps	N/A	23 Mbps	N/A
<b>HSPA+ (2X2 MIMO DL and UL, DL 64 QAM, UL 16 QAM, Eight-Carrier, 40+10 MHz)</b>	336 Mbps	N/A	69 Mbps	N/A
<b>HSPA+ (4X2 MIMO DL, 2X2 MIMO UL, DL 64 QAM, UL 16 QAM, 8 carrier, 40+10 MHz)</b>	672 Mbps	N/A	69 Mbps	N/A

<sup>252</sup> 5G Americas member company analysis. Assumes Release 7 with 64 QAM and F-DPCH. Single user. 50% loading in neighboring cells. Higher rates expected with subsequent 3GPP releases.

<sup>253</sup> No operators have announced plans to deploy HSPA in a quad (or greater) carrier configuration. Three carrier configurations, however, have been deployed.

	Downlink		Uplink	
	Peak Network Speed	Peak and/or Typical User Rate	Peak Network Speed	Peak and/or Typical User Rate
<b>EDGE (type 2 MS)</b>	473.6 Kbps	Not Applicable (N/A)	473.6 Kbps	N/A
<b>EDGE (type 1 MS) (Practical Terminal)</b>	236.8 Kbps	200 Kbps peak 160 to 200 Kbps typical <sup>254</sup>	236.8 Kbps	200 Kbps peak 80 to 160 Kbps typical <sup>255</sup>
<b>CDMA2000 EV-DO Rel. 0</b>	2.4 Mbps	> 1 Mbps peak	153 Kbps	150 Kbps peak
<b>CDMA2000 EV-DO Rev. A</b>	3.1 Mbps	> 1.5 Mbps peak 600 Kbps to 1.4 Mbps typical <sup>256</sup>	1.8 Mbps	> 1 Mbps peak 300 to 500 Kbps typical
<b>CDMA2000 EV-DO Rev. B (3 radio channels 5+5 MHz)</b>	14.7 <sup>257</sup> Mbps	Proportional increase of Rev A typical rates based on number of carriers.	5.4 Mbps	N/A
<b>CDMA2000 EV-DO Rev B Theoretical (15 radio channels 20+20 MHz)</b>	73.5 Mbps	N/A	27 Mbps	N/A

<sup>254</sup> Assumes four-to-five downlink timeslot devices (each timeslot capable of 40 Kbps).

<sup>255</sup> Assumes two-to-four uplink timeslot devices (each timeslot capable of 40 Kbps).

<sup>256</sup> Typical downlink and uplink throughput rates based on Sprint press release Jan. 30, 2007.

<sup>257</sup> Assuming use of 64 QAM.

Additional information about LTE throughput appears below in the section “LTE Throughput.”

## Latency Comparison

As important as throughput is network latency, defined as the round-trip time it takes data to traverse the network. Each successive data technology from GPRS forward reduces latency, with LTE networks having latency as low as 15 msec. Ongoing improvements in each technology mean that all of these values will go down as vendors and operators fine-tune their systems. Figure 104 shows the latency of different 3GPP technologies.

**Figure 104: Latency of Different Technologies<sup>258</sup>**

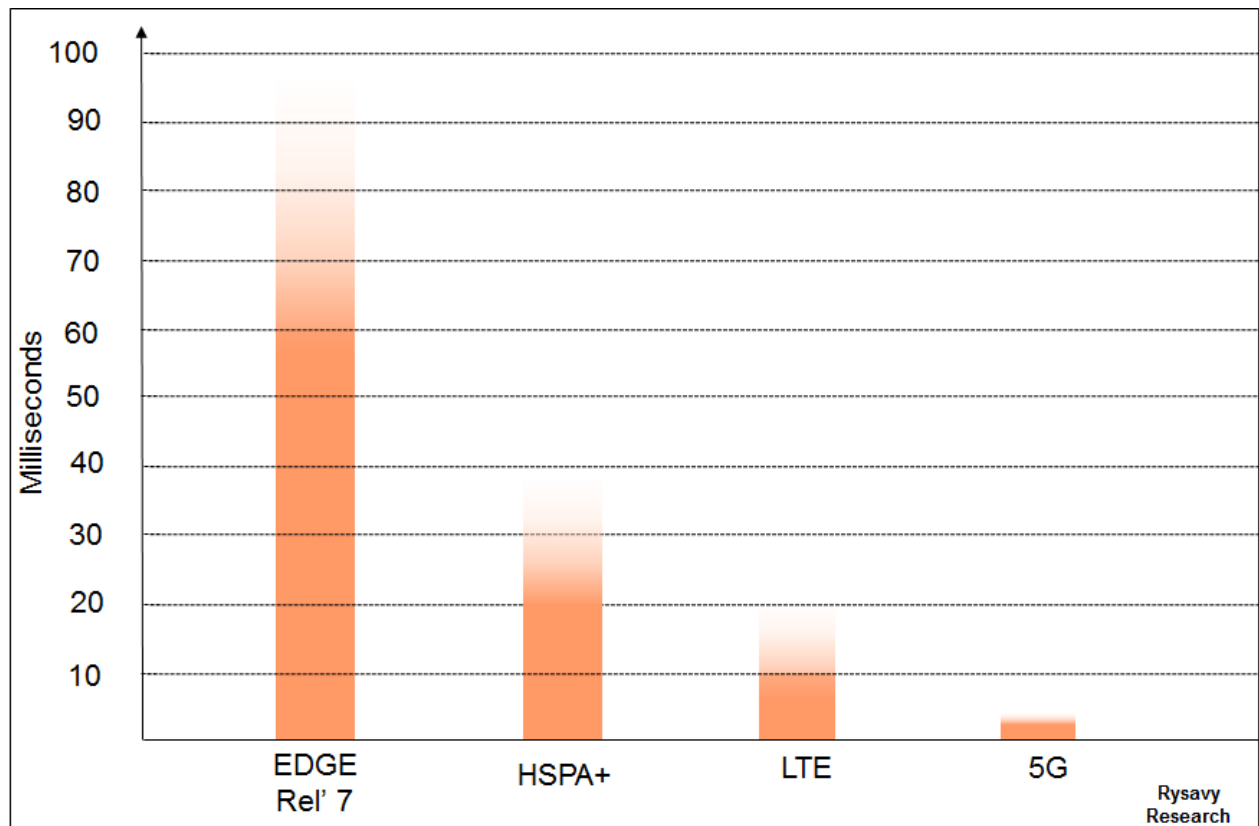

The values shown in Figure 104 reflect measurements of commercially deployed technologies, with EDGE Release 7 achieving 70 to 95 msec, HSPA+ 25 to 30 msec, and LTE 15 to 20 msec. A latency goal for 5G is less than 4 msec for broadband and 0.5 msec for mission-critical applications.

<sup>258</sup> 5G Americas member companies. Measured between subscriber unit and a node immediately external to wireless network. Does not include internet latency. Note that there is some variation in latency based on network configuration and operating conditions.

## Data Consumed by Streaming and Virtual Reality

Table 32 quantifies usage based on advanced video compression schemes such as H.264 and H.265, the type of application, and usage per day.

**Table 32: Data Consumed by Streaming and Virtual Reality<sup>259</sup>**

Application	Throughput (Mbps)	MByte/hour	Hrs./day	GB/month
Audio or Music	0.1	58	0.5	0.9
			1.0	1.7
			2.0	3.5
			4.0	6.9
Small Screen Video (e.g., Feature Phone)	0.2	90	0.5	1.4
			1.0	2.7
			2.0	5.4
			4.0	10.8
Medium Screen Video (e.g., Smartphone, Tablet, Laptop)	1.0	450	0.5	6.8
			1.0	13.5
			2.0	27.0
			4.0	54.0
Larger Screen Video (e.g., 720p medium definition)	3.0	1350	0.5	20.3
			1.0	40.5
			2.0	81.0
			4.0	162.0
High Definition (e.g., 1080p Netflix HD)	5.0	2250	0.5	33.8
			1.0	67.5
			2.0	135
			4.0	270
4K Ultra-High Definition (Rates will range 12 to 30 Mbps)	20.0	9000	0.5	135
			1.0	270
			2.0	540
			4.0	1080
4G, 30 FPS, Virtual Reality (Rates will range 10 to 50 Mbps)	25.0	11250	0.5	169
			1.0	338
			2.0	675
			4.0	1350
8K, 90 FPS, Virtual Reality (Rates will exceed 200 Mbps)	200.0	90000	0.5	1350
			1.0	2700
			2.0	5400
			4.0	10800
6 Degrees Freedom VR (Rates will range 200 to 1,000 Mbps)	500.0	225000	0.5	3375
			1.0	6750
			2.0	13500
			4.0	27000
Rysavy Research				

<sup>259</sup> Rysavy Research analysis. For virtual reality-data requirements, refer to ABI Research/Qualcomm, *Augmented and Virtual Reality: the First Wave of 5G Killer Apps*, 2017. See also Netflix discussion of usage, "How can I control how much data Netflix uses?" <https://help.netflix.com/en/node/87>. Viewed May 3, 2016.

## ***LTE, LTE-Advanced, and LTE-Advanced Pro***

Although HSPA and HSPA+ offer a highly efficient broadband-wireless service that will enjoy success for the remainder of this decade and well into the next, 3GPP completed the specification for Long Term Evolution as part of Release 8. LTE offers even higher peak throughputs in wider spectrum bandwidth. Work on LTE began in 2004 with an official work item started in 2006 and a completed specification early 2009. Initial deployments began in 2010.

LTE uses OFDMA on the downlink, which is well suited to achieve high peak data rates in high-spectrum bandwidth. WCDMA radio technology is basically as efficient as OFDM for delivering peak data rates of about 10 Mbps in 5 MHz of bandwidth. Achieving peak rates in the 100 Mbps range with wider radio channels, however, would result in highly complex terminals, and it is not practical with current technology, whereas OFDM provides a practical implementation advantage. Scheduling approaches in the frequency domain can also minimize interference, thereby boosting spectral efficiency. The OFDMA approach is also flexible in channelization: LTE operates in various radio channel sizes ranging from 1.4 to 20 MHz.

On the uplink, however, a pure OFDMA approach results in high peak-to-average power ratio of the signal, which compromises power efficiency and, ultimately, battery life. Hence, LTE uses SC-FDMA.

LTE capabilities include:

- ❑ Downlink peak data rates up to 300 Mbps with 20+20 MHz bandwidth in initial versions, increasing to over 1 Gbps in subsequent versions through carrier aggregation, higher-order modulation, and 4X4 MIMO.
- ❑ Uplink peak data rates up to 71 Mbps with 20+20 MHz bandwidth in initial versions, increasing to over 1 Gbps in subsequent versions.
- ❑ Operation in both TDD and FDD modes.
- ❑ Scalable bandwidth up to 20+20 MHz covering 1.4, 3, 5, 10, 15, and 20 MHz radio carriers.
- ❑ Increased spectral efficiency over HSPA by a factor of two to four.
- ❑ Reduced latency, to 15 msec round-trip times between user equipment and the base station, and to less than 100 msec transition times from inactive to active.
- ❑ Self-organizing capabilities under operator control and preferences that will automate network planning and will result in lower operator costs.

### **LTE-Advanced and LTE-Advanced Pro**

LTE-Advanced, as specified in Release 10, is a term used for the version of LTE that addresses IMT-Advanced requirements. The ITU ratified LTE-Advanced as IMT-Advanced in November 2010. LTE-Advanced is both backward- and forward-compatible with LTE, meaning LTE devices operate in newer LTE-Advanced networks, and LTE-Advanced devices operate in older, pre-Release 10 LTE networks.

The following lists at a high level the most important features of LTE-Advanced, as well as other features planned for subsequent releases, including Release 11:

- ❑ Carrier aggregation.

- ❑ Higher-order downlink MIMO (up to 8X8 in Release 10).
- ❑ Uplink MIMO (two transmit antennas in the device).
- ❑ Coordinated multipoint transmission (CoMP) in Release 11.
- ❑ Heterogeneous network (HetNet) support including Enhanced Inter-cell Interference Coordination (eICIC).
- ❑ Relays.

3GPP, from Release 13, has referred to LTE as LTE-Advanced Pro, which includes features such as LAA, LWA, low latency, and massive MIMO.

## OFDMA and Scheduling

LTE implements OFDM in the downlink. The basic principle of OFDM is to split a high-rate data stream into a number of parallel, low-rate data streams, each a narrowband signal carried by a subcarrier. The different narrowband streams are generated in the frequency domain, and then combined to form the broadband stream using a mathematical algorithm called an "Inverse Fast Fourier Transform" (IFFT) that is implemented in digital signal processors. In LTE, the subcarriers have 15 kHz spacing from each other. LTE maintains this spacing regardless of the overall channel bandwidth, which simplifies radio design, especially in supporting radio channels of different widths. The number of subcarriers ranges from 72 in a 1.4 MHz radio channel to 1,200 in a 20 MHz radio channel.

The composite signal obtained after the IFFT is extended by repeating the initial part of the signal (called the Cyclic Prefix [CP]). This extended signal represents an OFDM symbol. The CP is basically a guard time during which reflected signals will reach the receiver. It results in an almost complete elimination of multipath-induced Intersymbol Interference (ISI), which otherwise makes extremely high data rate transmissions problematic. The system is called orthogonal because the subcarriers are generated in the frequency domain (making them inherently orthogonal), and the IFFT conserves that characteristic.

OFDM systems may lose their orthogonal nature as a result of the Doppler shift induced by the speed of the transmitter or the receiver. 3GPP specifically selected the subcarrier spacing of 15 kHz to avoid any performance degradation in high-speed conditions. WiMAX systems that use a lower subcarrier spacing (~11 kHz) are more impacted in high-speed conditions than LTE.

**Figure 105: OFDM Symbol with Cyclic Prefix**

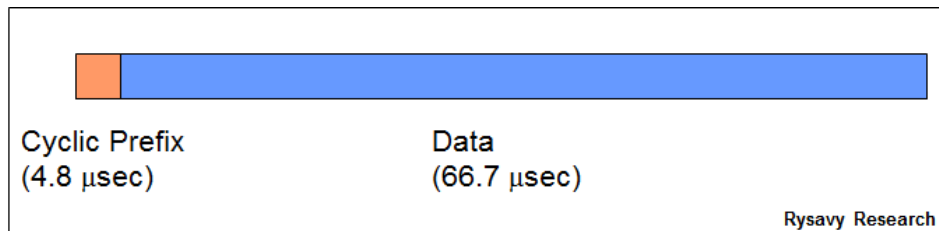

The multiple access aspect of OFDMA comes from being able to assign different users different subcarriers over time. A minimum resource block that the system can assign to a user transmission consists of 12 subcarriers over 14 symbols in 1.0 msec. Figure 106 shows how the system can assign these resource blocks to different users over both time and frequency.

**Figure 106: LTE OFDMA Downlink Resource Assignment in Time and Frequency**

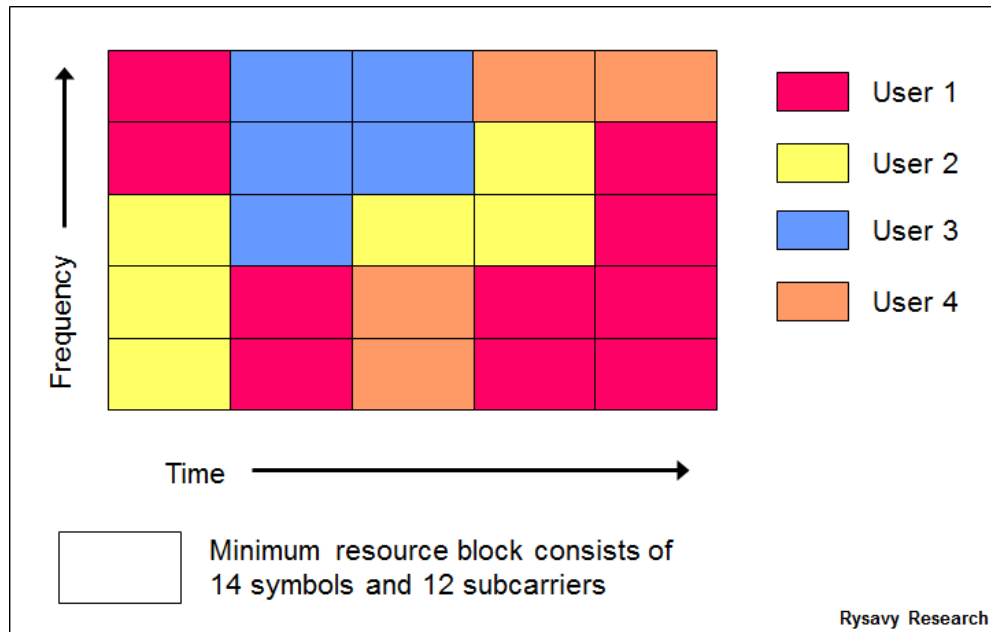

By controlling which subcarriers are assigned in which sectors, LTE can easily control frequency reuse. Using all the subcarriers in each sector, the system would operate at a frequency reuse of 1; but by using a different one third of the subcarriers in each sector, the system can achieve a looser frequency reuse of 1/3. The looser frequency reduces overall spectral efficiency but delivers high peak rates to users.

Beyond controlling frequency reuse, frequency domain scheduling, as shown in Figure 107 can use those resource blocks that are not faded, not possible in CDMA-based systems. Since different frequencies may fade differently for different users, the system can allocate those frequencies for each user that result in the greatest throughput. This results in up to a 40% gain in average cell throughput for low user speed (3 km/hour), assuming a large number of users and no MIMO. The benefit decreases at higher user speeds.

**Figure 107: Frequency Domain Scheduling in LTE<sup>260</sup>**

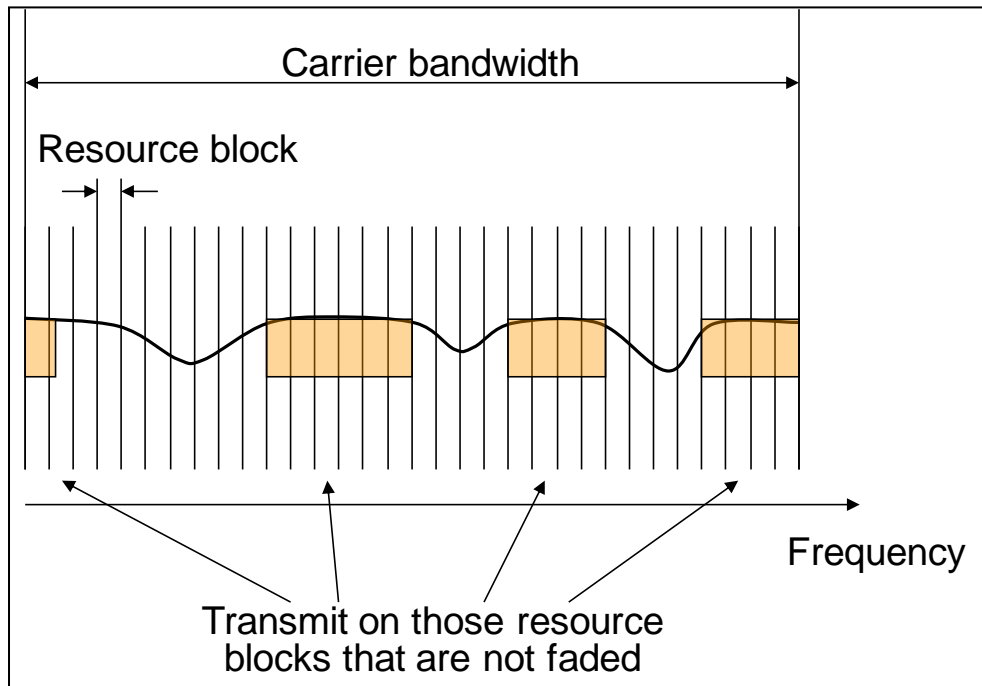

### LTE Smart Antennas

Wireless networks can achieve significant gains by employing multiple antennas, either at the base station, the mobile device, or both. LTE uses multiple antennas in three fundamentally different ways:

- ❑ **Diversity.** So long as the antennas are spaced or polarized appropriately, the antennas provide protection against fading.
- ❑ **Beamforming.** Multiple antennas can shape a beam to increase the gain for a specific receiver. Beamforming can also suppress specific interfering signals. Beamforming is particularly helpful for improving cell-edge performance.
- ❑ **Spatial Multiplexing.** Often referred to as MIMO antenna processing, spatial multiplexing creates multiple transmission paths through the environment, effectively sending data in parallel through these paths, thus increasing both throughput and spectral efficiency.

Table 33 shows the various antenna transmission modes.

---

<sup>260</sup> 5G Americas member contribution.



**Table 33: LTE Transmission Modes<sup>261</sup>**

Transmission Mode	Description
1	Single antenna transmission.
2	Transmit Diversity.
3	Transmit diversity for one layer, open-loop codebook-based precoding if more than one layer.
4	Closed-loop codebook-based precoding.
5	Multi-user MIMO version of transmission mode 4.
6	Special case of closed-loop codebook-based precoding limited to single layer transmission.
7	Beamforming. (Non-codebook-based precoding supporting one layer.)
8	Dual-layer beamforming. (Release 9. Non-codebook-based precoding supporting up to two layers.)
9	8-layer transmission. (Release 10. Non-codebook-based precoding supporting up to eight layers.)
10	8-layer transmission with support for CoMP. (Release 11.)

Being able to exploit different antenna modes based on local conditions produces huge efficiency and performance gains and is the reason that 3GPP is developing even more advanced antenna modes in subsequent LTE releases.

Precoding refers to a mathematical matrix operation performed on radio symbols to determine how they are combined and mapped onto antenna ports. The precoder matrix can operate in either open-loop or closed-loop modes. For each transmission rank for a given number of transmission ports (antennas), there is a limited set of precoder matrices defined, called the codebook. This helps limit the amount of signaling needed on uplink and downlink.

Fundamental variables distinguish the different antenna modes:

- **Single base station antenna versus multiple antennas.** Single antennas provide for Single Input Single Output (SISO), SIMO, and planar-array beamforming. (Multiple Output means the UE has multiple antennas.) Multiple antennas at the base station provide for different MIMO modes such as 2X2, 4X2, and 4X4.

---

<sup>261</sup> Erik Dahlman, Stefan Parkvall, Johan Skold, *4G - LTE/LTE Advanced for Mobile Broadband*, Academic Press, 2011.

- ❑ **Single-user MIMO versus multi-user MIMO.** Release 8 only provides for single-user MIMO on the downlink. Release 10 includes multi-user MIMO.
- ❑ **Open-Loop versus Closed-Loop.** High vehicular speeds require open-loop operation whereas slow speeds enabled closed-loop operation in which feedback from the UE modifies the transmission. In closed-loop operation, the precoder matrix is based on this feedback.
- ❑ **Rank.** In a MIMO system, the channel rank is formally defined as the rank of the channel matrix and is a measure of the degree of scattering that the channel exhibits. For example, in a 2x2 MIMO system, a rank of one indicates a low-scattering environment, while a rank of two indicates a high-scattering environment. The rank two channel is highly uncorrelated and is thus able to support the spatial multiplexing of two data streams, while a rank one channel is highly correlated, and thus can only support single stream transmission (the resulting multi-stream interference in a rank one channel as seen at the receiver would lead to degraded performance). Higher Signal to Interference plus Noise Ratios (SINR) are typically required to support spatial multiplexing, while lower SINRs are typically sufficient for single stream transmission. In a 4x4 MIMO system channel rank values of three and four are possible in addition to values of one and two. The number of data streams, however, or more specifically codewords in LTE is limited to a value of two. Thus, LTE has defined the concept of layers, in which the DL transmitter includes a codeword-to-layer mapping, and in which the number of layers is equal to the channel rank. An antenna mapping or precoding operation follows, which maps the layers to the antenna ports. A 4x2 MIMO system is also possible with LTE Release 8, but here the channel rank is limited to the number of UE antennas, which is equal to two.

The network can dynamically choose between different modes based on instantaneous radio conditions between the base station and the UE. Figure 108 shows the decision tree. The antenna configuration (AC) values refer to the transmission modes. Not every network will support every mode. Operators will choose which modes are the most effective and economical. AC2, 3, 4, and 6 are typical modes that will be implemented.

**Figure 108: Decision Tree for Different Antenna Schemes<sup>262</sup>**

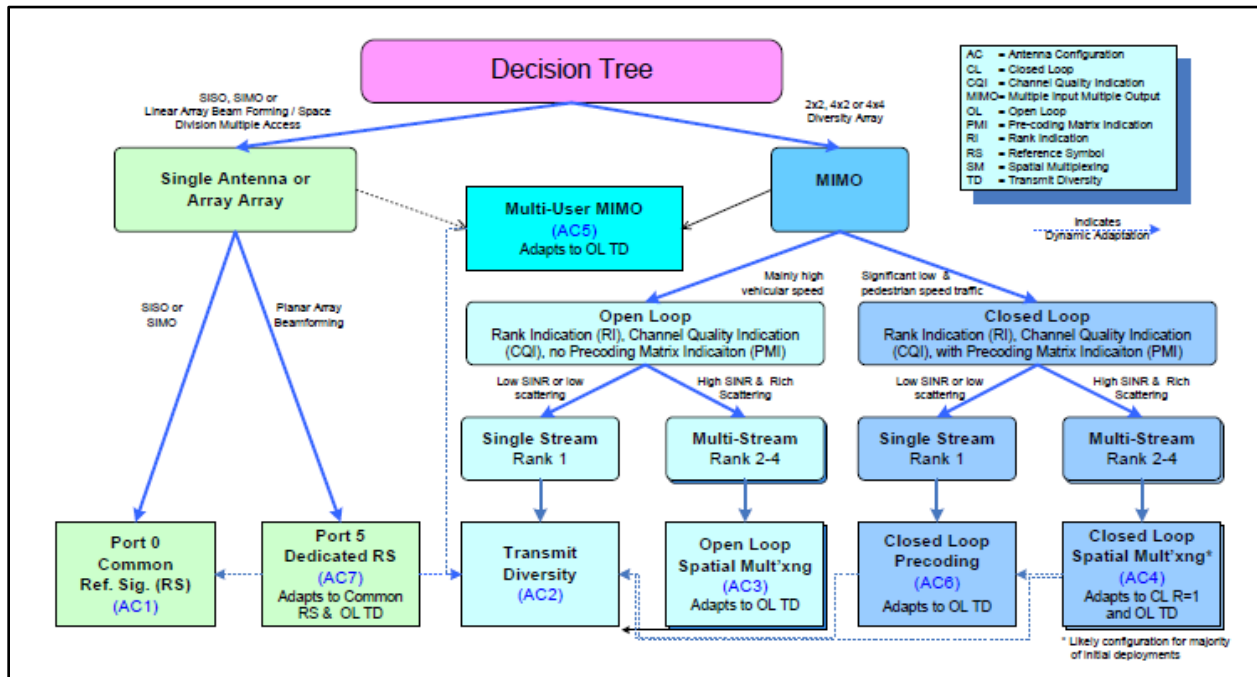

The simplest mode is AC2, referred to as Transmit Diversity (TD) or sometimes Space Frequency Block Code (SFBC) or even Open Loop Transmit Diversity. TD can operate under all conditions, meaning it works under low SINR, high mobility, and low channel rank (rank = 1). This rank means that the channel is not sufficiently scattered or de-correlated to support two spatial streams. Thus, in TD, only one spatial stream or what is sometimes referred as a single codeword (SCW) is transmitted. If the channel rank increases to a value of two, indicating a more scattered channel, and the SINR is a bit higher, then the system can adapt to AC3 or Open-Loop Spatial Multiplexing (OL-SM), also referred to as large-delay Cyclic Delay Diversity (CDD). This mode supports two spatial streams or two codewords. This mode, also called multiple codeword (MCW) operation, increases throughput over SCW transmission.

If the rank of the channel is one, but the device is not moving very fast or is stationary, then the system can adapt to AC6, called closed-loop (CL) precoding (or CL-rank 1 or CL-R1). In this mode, the network receives from the device with Precoding Matrix Indication (PMI) bits that inform the base station what precoding matrix to use in the transmitter to optimize link performance. This feedback is only relevant for low-mobility or stationary conditions since in high mobility conditions the feedback will most likely be outdated by the time the base station can use it.

Another mode is AC4 or Closed Loop Spatial Multiplexing (CL-SM), which is enabled for low-mobility, high SINR, and channel rank of two. This mode theoretically provides the best user throughput. The figure above shows how these modes can adapt downwards to either OL TD, or if in CL-SM mode, down to either OL TD or CL R1.

<sup>262</sup> 4G Americas, *MIMO and Smart Antennas for 3G and 4G Wireless Systems – Practical Aspects and Deployment Considerations*, May 2010.

For a 4x4 MIMO configuration, the channel rank can take on values of three and four in addition to one or two. Initial deployment at the base station, however, will likely be two TX antennas and most devices will only have 2 RX antennas, and thus the rank is limited to 2.

AC5 is MU-MIMO, which is not defined for the downlink in Release 8.

AC1 and AC7 are single antenna port modes in which AC1 uses a common Reference Signal (RS), while AC7 uses a dedicated RS or what is also called a user specific RS. AC1 implies a single TX antenna at the base station. AC7 implies an antenna array with antennal elements closely spaced so that a physical or spatial beam can be formed toward an intended user.

LTE operates in a variety of MIMO configurations. On the downlink, these include 2X2, 4X2 (four antennas at the base station), and 4X4. Initial deployment will likely be 2x2 whereas 4X4 will be most likely used initially in femtocells. On the uplink, there are two possible approaches: single-user MIMO (SU-MIMO) and multi-user MIMO (MU-MIMO). SU-MIMO is more complex to implement as it requires two parallel radio transmit chains in the mobile device, whereas MU-MIMO does not require any additional implementation at the device but relies on simultaneous transmission on the same tones from multiple mobile devices.

The first LTE Release thus incorporates MU-MIMO with SU-MIMO deferred for subsequent LTE releases. An alternate form of MIMO, originally called network MIMO, and now called CoMP, relies on MIMO implemented (on either the downlink or uplink or both) using antennas across multiple base stations, as opposed to multiple antennas at the same base station. This paper explains CoMP in the section on LTE Advanced below.

Peak data rates are approximately proportional to the number of send and receive antennas. 4X4 MIMO is thus theoretically capable of twice the data rate of a 2X2 MIMO system. The spatial multiplexing MIMO modes that support the highest throughput rates will be available in early deployments.

For a more detailed discussion of 3GPP antenna technologies, refer to the 5G Americas white paper "MIMO and Smart Antennas for 3G and 4G Wireless Systems – Practical Aspects and Deployment Considerations," May 2010.

For advancements in LTE Smart Antennas, see the next section.

## **LTE-Advanced Antenna Technologies**

Release 10 added significant enhancements to antenna capabilities, including four-layer transmission resulting in peak spectral efficiency exceeding 15 bps/Hz. Uplink techniques fall into two categories: those relying on channel reciprocity and those that do not. With channel reciprocity, the eNB determines the channel state by processing a Sounding Reference Signal from the UE. It then forms transmission beams accordingly. The assumption is that the channel received by the eNB is the same as the UE. Techniques that use channel reciprocity are beamforming, SU-MIMO, and MU-MIMO. Channel reciprocity works especially well with TDD since both forward and reverse links use the same frequency.

Non-reciprocity approaches apply when the transmitter has no knowledge of the channel state. Techniques in this instance include open-loop MIMO, closed-loop MIMO, and MU-MIMO. These techniques are more applicable for higher speed mobile communications.

For the downlink, the technology can transmit in as many as eight layers using an 8X8 configuration for a peak spectral efficiency of 30 bps/Hz. This exceeds the IMT-Advanced requirements, conceivably supporting a peak rate of 1 Gbps in just 40+40 MHz, and even higher rates in wider bandwidths. This would require additional reference signals for channel estimation and for measurements, including channel quality, to enable adaptive, multi-antenna transmission.

Release 10 supports a maximum of two codewords, the same as previous LTE releases. The release specifies a new transmission mode (TM-9) that supports SU-MIMO up to Rank 8 (up to eight layers), as well as the ability to dynamically switch between SU-MIMO and MU-MIMO.

Figure 109 shows the different forms of single-user MIMO in Releases 8, 9, and 10. Release 8 supports only a single layer, whereas two-layer beamforming is possible in Release 9, and eight layers are possible in Release 10 with eight antennas at the base station.

**Figure 109: Single-User MIMO<sup>263</sup>**

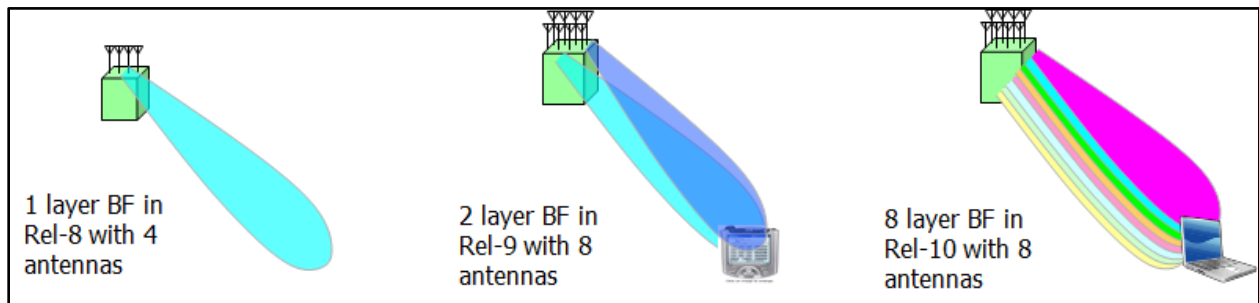
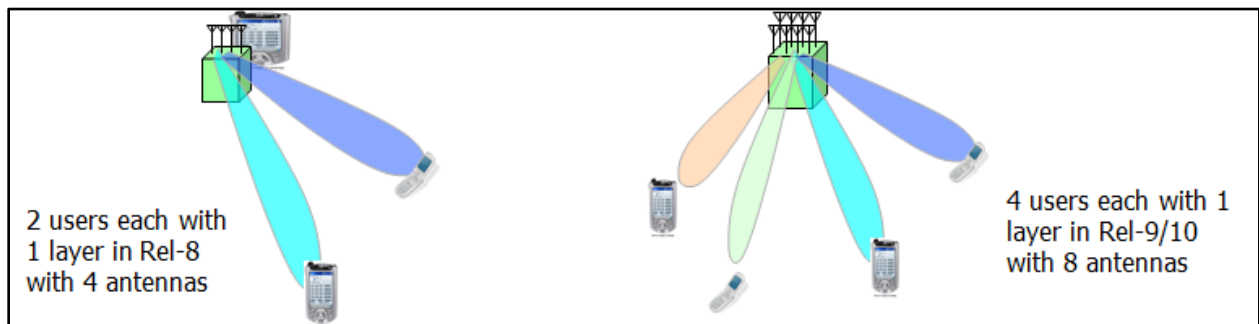

Figure 110 shows multi-user MIMO options across different releases. Release 8 supports two simultaneous users, each with one layer using four antennas, while Releases 9 and 10 support four simultaneous users, each with one layer.

**Figure 110: Multi-User MIMO<sup>264</sup>**



For four-antenna configurations at the base station, Release 12 improves throughput by adding a feedback mode, called mode 3-2, in which sub-band precoders and sub-band

<sup>263</sup> 5G Americas member contribution.

<sup>264</sup> 5G Americas member contribution.

channel quality indicators (CQIs) are included in the UE’s feedback to the eNodeB. Release 12 also adds a new codebook that further improves throughput.

As depicted in Figure 111 and Figure 112, compared with the Release 8 codebook, the new Release 12 codebook provides a 10% gain for both median and cell-edge throughputs. Compared with feedback mode 3-1, feedback mode 3-2 provides an 18% to 20% gain in median and cell-edge throughput. Jointly, the two methods provide a 28% to 30% gain.

**Figure 111: Median Throughput of Feedback Mode 3-2 and New Codebook.<sup>265</sup>**

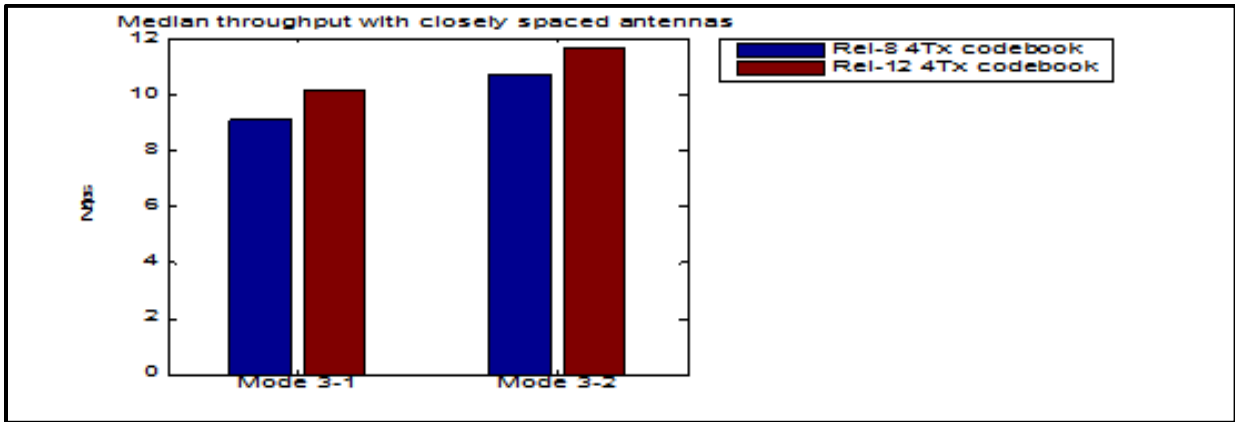

**Figure 112: Cell-Edge Throughput of Feedback Mode 3-2 and New Codebook<sup>266</sup>**

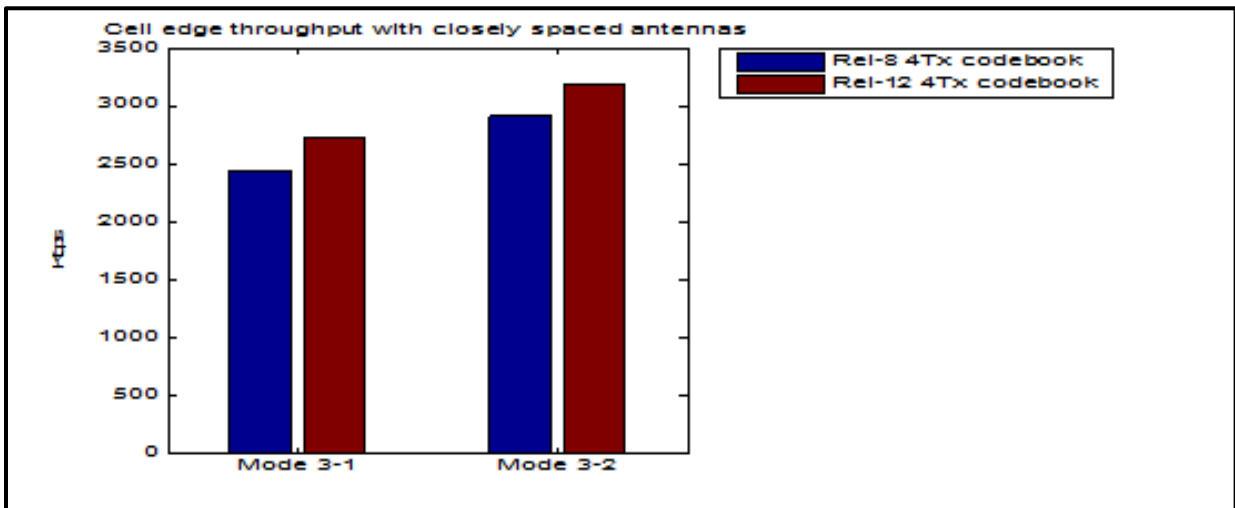

Release 12 also defines how Active Antenna Systems can use multiple transceivers on an antenna array to dynamically adjust a radiation pattern.

<sup>265</sup> 5G Americas member contribution. Assumptions include: cellular layout of 19 sites hexagonal grid with three sectors per site and 500-meter inter-site distance; simulation case ITU uMa for macro; carrier frequency 2 GHz, deployment scenario A homogenous macro; SU-MIMO with maximum two layers per UE; proportional fair scheduler; and bursty traffic model.

<sup>266</sup> 5G Americas member contribution. Same assumptions as previous figure.

Release 13 defined full-dimension MIMO, which supported up to 16 antenna ports, and Release 14 added support for up to 32 antenna ports.

A practical consideration with antennas is that many towers today already support multiple operators, with tower companies having to manage interference placement, spectrum allocations, and wind and snow load. At higher frequencies, a single radome (antenna enclosure) can support 4X2 MIMO, but higher-order MIMO may prove impractical for many deployments.

5G systems operating at much higher frequencies will have an advantage since the antenna arrays will be much smaller due to the much smaller wavelengths.

Initial massive MIMO techniques applied to LTE, such as full-dimension MIMO using 8, 16, and 64 transmit antennas, can provide dramatic performance gains, particularly in dense deployments, as shown in Figure 113.

**Figure 113: Performance Gains with FD-MIMO Using 200 Meter ISD<sup>267</sup>**

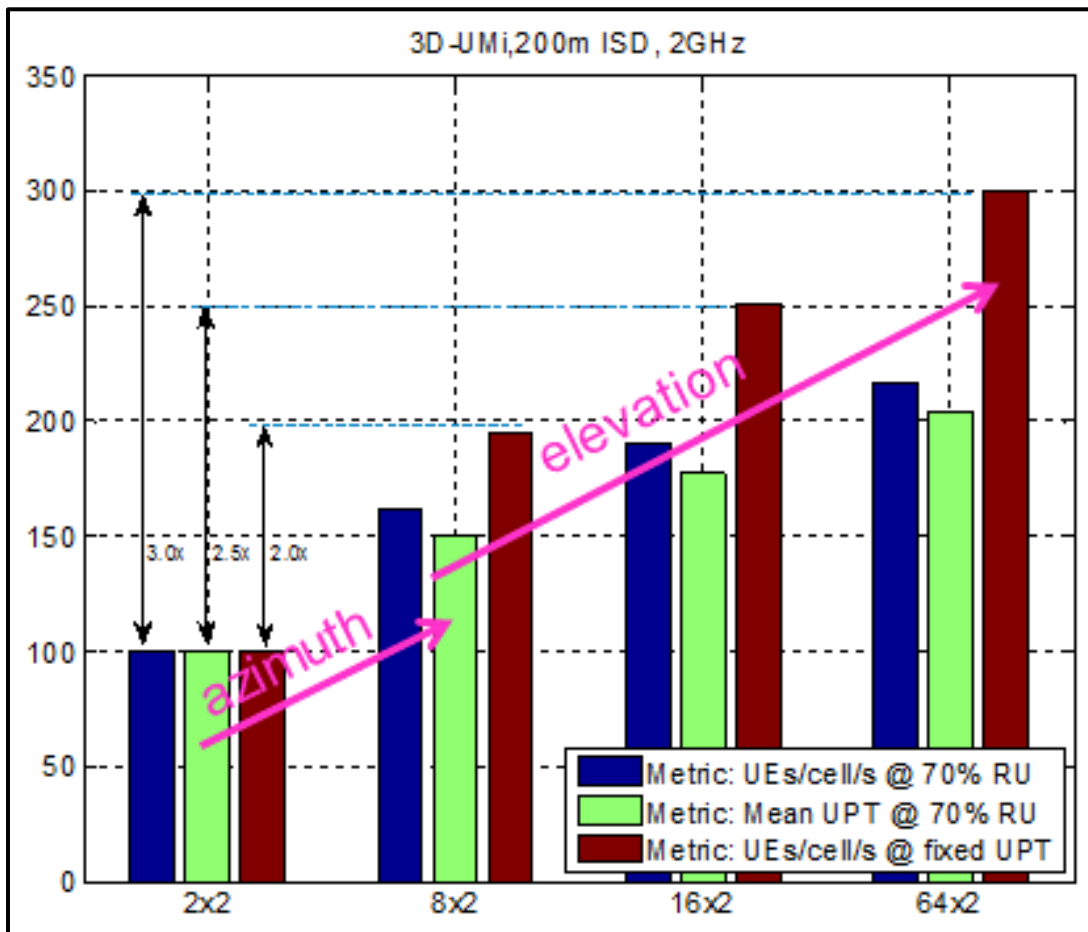

This figure compares 8X2, 16X2, and 64X2 MIMO performance relative to 2X2 MIMO (normalized to value 100). The blue bars (case 1) show the supported number of users per sector (referred to as "cell" in the figure) at a fixed resource utilization (RU) of 70%;

<sup>267</sup> 5G Americas member contribution.

the green bars (case 2) show mean user throughput (UPT) at a fixed RU of 70%; and the red bars (case 3) show system capacity in terms of supported number of users for a given user throughput. Resulting gains are:

- ❑ Case 2 (green bars): 1.5X with 8X2, 1.75X with 16X2, and 2X with 64X2 MIMO.
- ❑ Case 3 (red bars): 2X with 8X2, 2.5X with 16X2, and 3X with 64X2 MIMO.

The primary gains are from azimuth (horizontal dimension) in going from 2X2 to 8X2, and from elevation in going to 16X2 and 64X2. FD-MIMO gains are lower with larger ISD values, such as 500 meters.

3GPP has also studied FD-MIMO and conducted a field trial showing impressive throughput gains, particularly in a high-rise scenario.<sup>268</sup>

## Carrier Aggregation

Carrier aggregation, first available in Release 10, plays an important role in providing operators maximum flexibility for using all of their available spectrum. By combining spectrum blocks, LTE can deliver much higher throughputs than otherwise possible. Asymmetric aggregation (for example, different amounts of spectrum used on the downlink versus the uplink) provides further flexibility and addresses the greater demand on downlink traffic.

Specific types of aggregation include:

- ❑ Intra-band on adjacent channels.
- ❑ Intra-band on non-adjacent channels.
- ❑ Inter-band (700 MHz, 1.9 GHz).
- ❑ Inter-technology (for example, LTE on one channel, HSPA+ on another). This approach is not currently specified nor being developed. While theoretically promising, a considerable number of technical issues would have to be addressed.<sup>269</sup> See Figure 114.

---

<sup>268</sup> 3GPP, *3D-MIMO Prototyping and Initial Field Trial Results*, TSG RAN WG1 Meeting #80, Agenda Item: 7.2.4.4, Document R1-150451.

<sup>269</sup> For further details, see 4G Americas, *HSPA+ LTE Carrier Aggregation*, Jun. 2012.



**Figure 114: Inter-Technology Carrier Aggregation<sup>270</sup>**

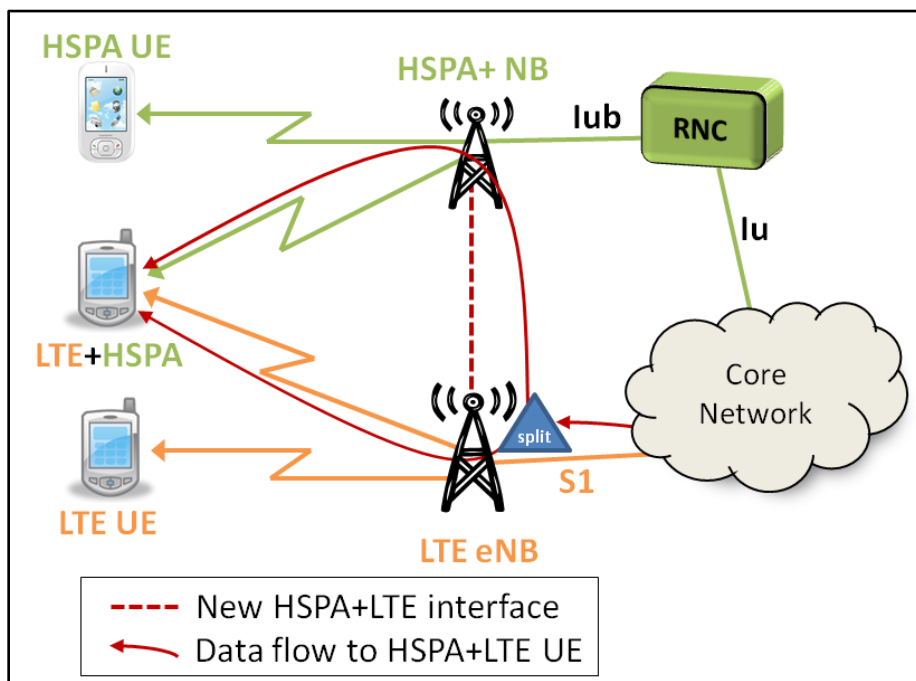
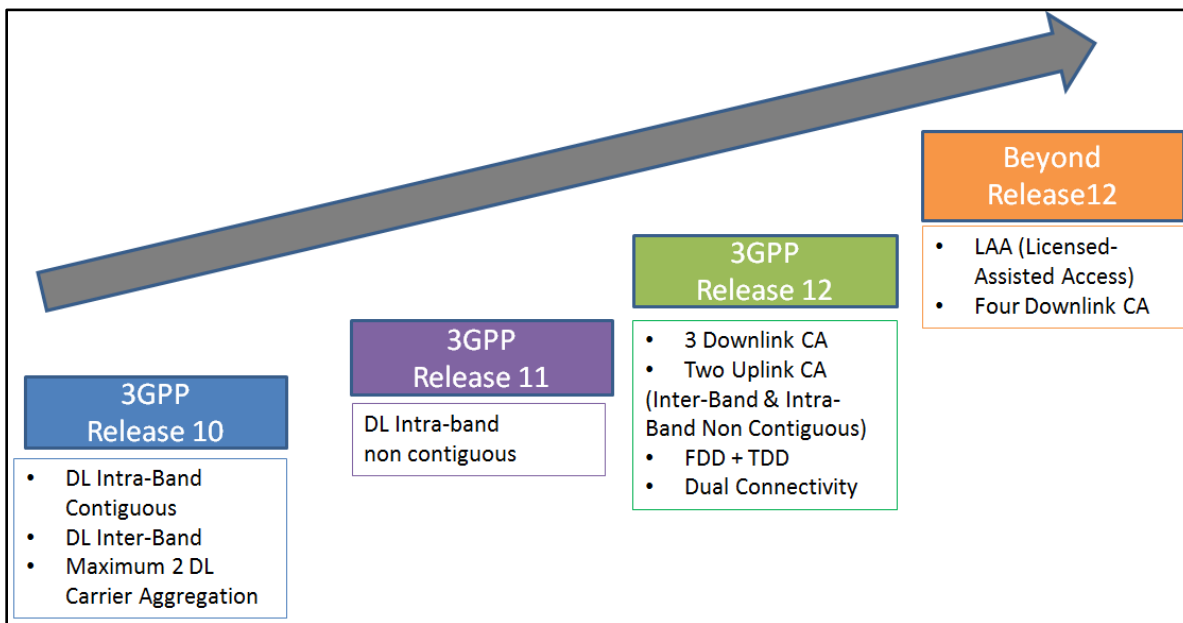

Figure 115 depicts the carrier-aggregation capabilities of different 3GPP releases.

**Figure 115: Carrier Aggregation Capabilities across 3GPP Releases<sup>271</sup>**



<sup>270</sup> 5G Americas member contribution.

<sup>271</sup> 4G Americas, *Mobile Broadband Evolution: Rel-12 & Rel-13 and Beyond*, 2015.

One anticipated benefit of inter-band aggregation stems from using the lower-frequency band for users who are at the cell edge, to boost their throughput rates. Though this approach improves average aggregate throughput of the cell by only a small amount (say, 10%), it results in a more uniform user experience across the cell coverage area.

Figure 116 shows an example of intra-band carrier aggregation using adjacent channels with up to 100+100 MHz of bandwidth supported. Radio-access network specifications, however, limit the number of carriers to two in Release 10 and Release 11.

**Figure 116: Release 10 LTE-Advanced Carrier Aggregation<sup>272</sup>**

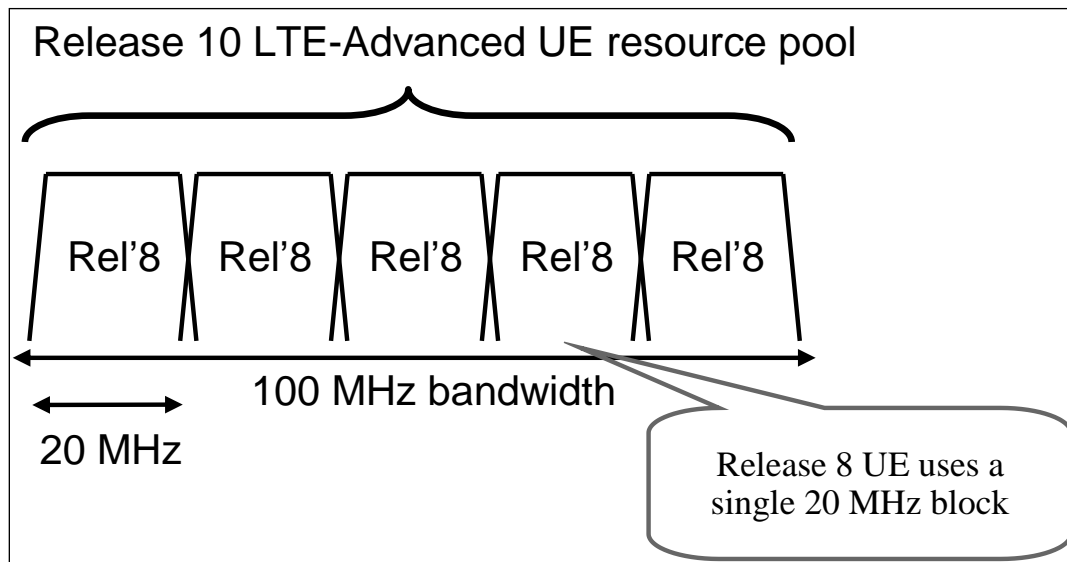
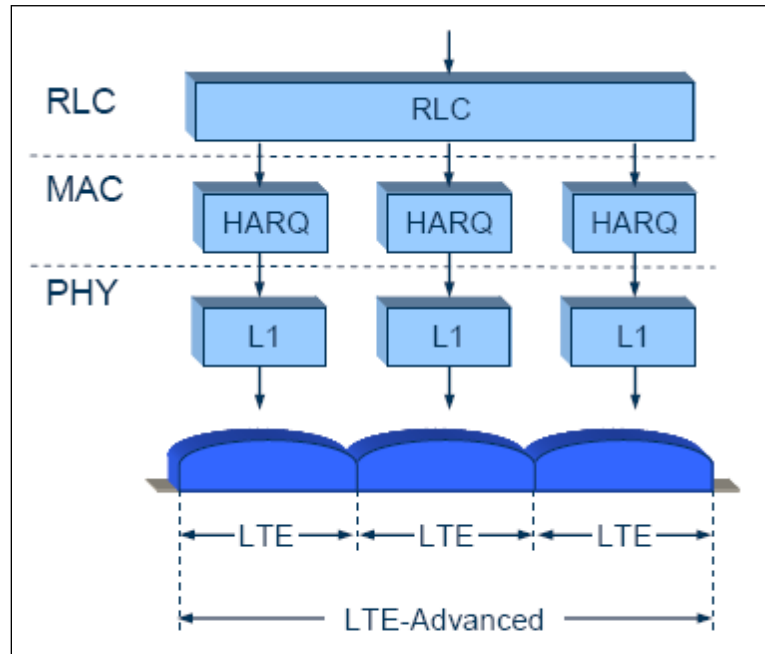

Figure 117 shows the carrier aggregation operating at different protocol layers.

---

<sup>272</sup> Harri Holma and Antti Toskala, *LTE for UMTS, OFDMA and SC-FDMA Based Radio Access*, Wiley, 2009.

**Figure 117: Carrier Aggregation at Different Protocol Layers<sup>273</sup>**



For a list of band combinations, refer to the 5G Americas white paper, *Wireless Technology Evolution Towards 5G: 3GPP Release 13 to Release 15 and Beyond*, February 2017, at section 3.4.3. Figure 118 shows the result of one simulation study that compares download throughput rates between the blue line, which shows five user devices in 700 MHz and five user devices in AWS not using CA, and the pink line, which shows ten user devices that have access to both bands. Assuming a lightly loaded network with CA, 50% or more users (the median) experience 91% greater throughput, and 95% or more users experience 50% greater throughput. These trunking gains are less pronounced in heavily loaded networks.

---

<sup>273</sup> Stefan Parkvall and David Astely, Ericsson Research, "The Evolution of LTE towards IMT-Advanced," *Journal of Communications*, Vol. 4, No. 3, Apr. 2009.  
<http://www.academypublisher.com/jcm/vol04/no03/jcm0403146154.pdf>.

**Figure 118: Gains from Carrier Aggregation<sup>274</sup>**

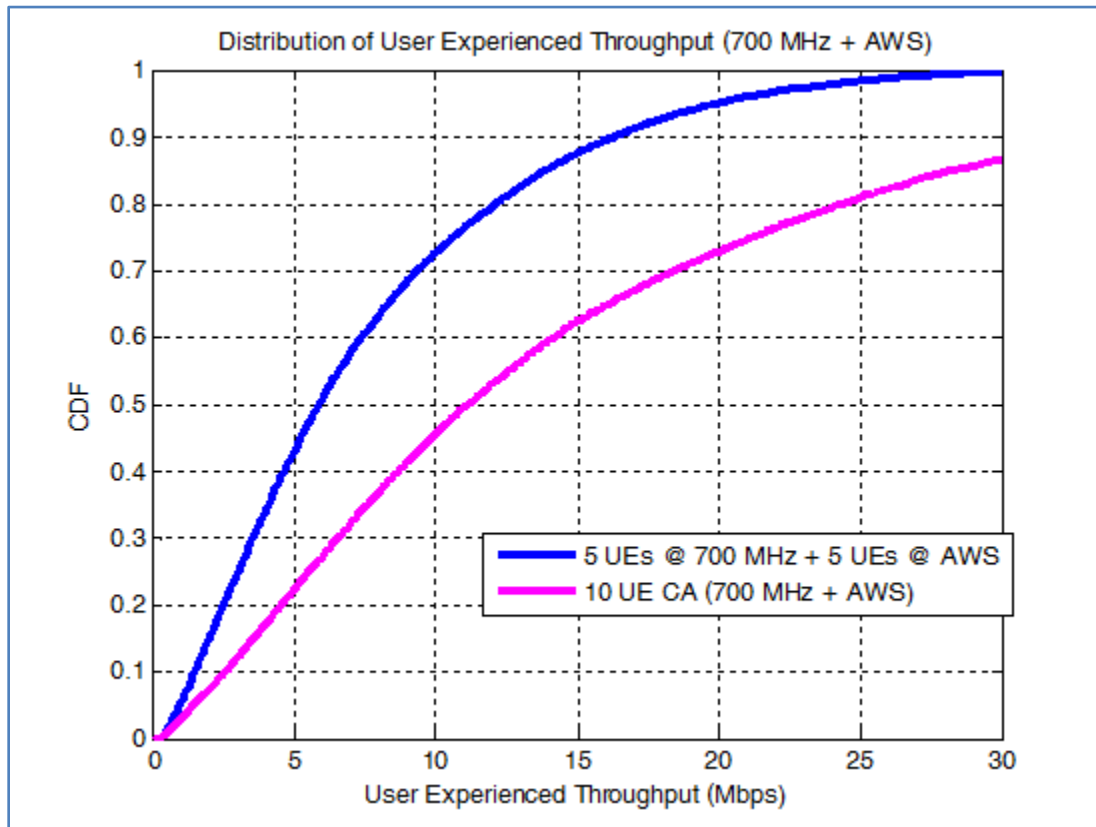

Work in Release 12 is investigating aggregation of joint TDD and FDD carriers.

### **Coordinated Multi Point (CoMP)**

Coordinated Multi Point (CoMP) is a communications technique that can improve coverage, cell-edge throughput, and/or system spectrum efficiency by reducing interference. This technique was thoroughly studied during the development of LTE-Advanced Release 10 and was standardized in Release 11.

CoMP coordinates transmissions at different cell sites, thereby achieving higher system capacity and improving cell-edge data rates.

The main principle of CoMP is that a UE at a cell edge location can receive signals from multiple transmission points, and/or its transmitted signal can be received by multiple reception points. Consequently, if these multiple transmission points coordinate their transmissions, the DL throughput performance and coverage can improve.

For the UL, signals from the UE received at multiple reception points can significantly improve the link performance. Techniques can range from simple interference avoidance methods, such as Coordinated Beam Switching (CBS) and Coordinated Beam Forming

---

<sup>274</sup> 5G Americas member contribution. Assumptions: lightly-loaded network, 2.0 site-to-site distance, file size is 750 Kbytes, traffic model bursty with mean inter-arrival time of five seconds.

(CBF), to complex joint processing techniques that include Joint Transmission (JT), Joint Reception (JR), and Dynamic Point Selection (DPS).

CoMP architectures include inter-site CoMP, intra-site CoMP, as well as CoMP with distributed eNBs (i.e., an eNB with distributed remote radio heads). Figure 119 shows two possible levels of coordination.

**Figure 119: Different Coordination Levels for CoMP<sup>275</sup>**

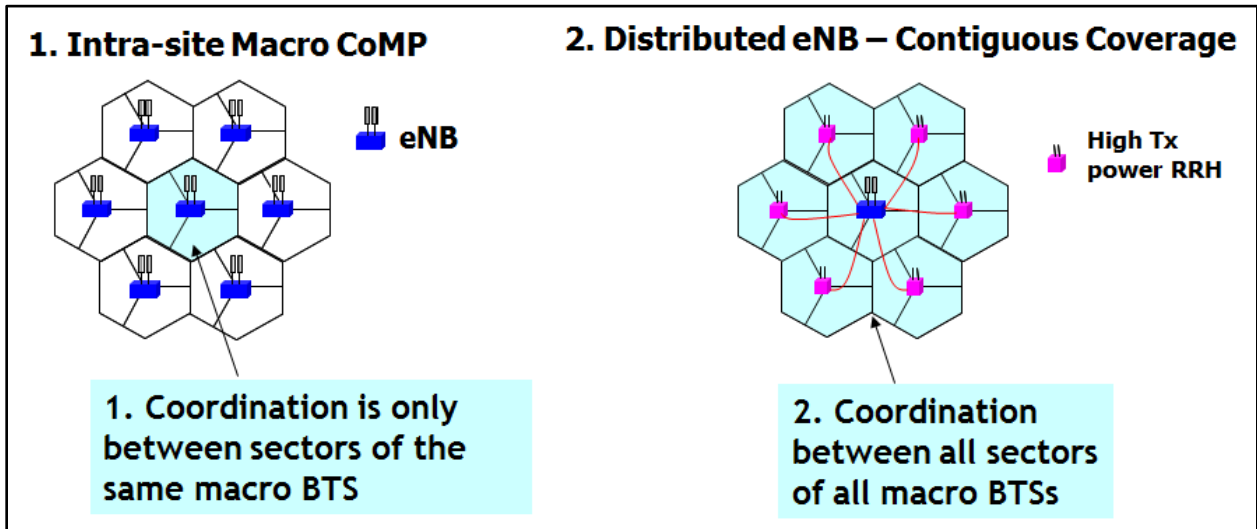

In one CoMP approach, called coordinated scheduling and shown in Figure 120, a single site transmits to the user, but with scheduling, including any associated beamforming, coordinated between the cells to reduce interference between the different cells and to increase the served user's signal strength. In Joint Transmission, another CoMP approach also shown in Figure 120, multiple sites transmit simultaneously to a single user. This approach can achieve higher performance than coordinated scheduling, but it has more stringent backhaul communications requirements. One simpler form of CoMP that will be available in Release 10, and then further developed in Release 11, is ICIC. Release 11 of LTE defines a common feedback and signaling framework for enhanced CoMP operation.

**Figure 120: Coordinated Scheduling/BF and Joint Processing CoMP Approaches<sup>276</sup>**

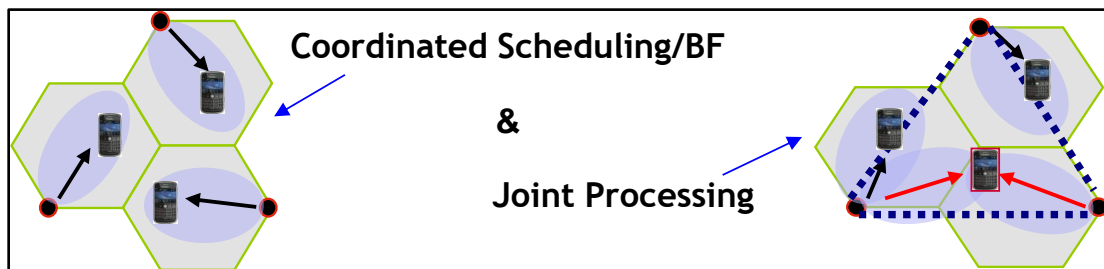

<sup>275</sup> 5G Americas member contribution.

<sup>276</sup> 5G Americas member contribution.

Release 11 also implements CoMP on the uplink, by which multiple base stations receive uplink transmissions and jointly process the signal, resulting in significant interference cancellation and improvements to spectral efficiency.

The performance gains expected from CoMP are under discussion in the industry. According to 3GPP document TR 36.819, for the case of resource utilization below 35%, CoMP may provide a 5.8% performance gain on the downlink for the mean user and a 17% gain for cell-edge users relative to HetNets without eICIC. For resource utilization of more than 35%, CoMP may provide a 17% mean gain and a 40% cell-edge gain.<sup>277</sup> CoMP can also be used in combination with eICIC for additional gains.

In the same 3GPP TR 36.819 document, 3GPP estimates the downlink CoMP gain in spectral efficiency, defined as average sector throughput for full buffer traffic using JT and 4x2 MU-MIMO as defined in R11, compared with 4x2 MU-MIMO based on R10, to be about 3% for intra-eNodeB CoMP. That gain drops to about 9% for inter-eNodeB CoMP in the case of no delay in the backhaul used to exchange information between eNodeBs. The corresponding gains in cell-edge user throughput are 20% and 31%, respectively.

When increasing the backhaul latency to a more realistic value of 10 msec for inter-eNodeB, spectral efficiency decreases to zero, and the cell edge gain decreases to 10%.

The gains for DL CoMP based on Coordinated Scheduling/Coordinated Beamforming (CS/CB) and intra-eNodeB are less than that provided by JT, with spectral efficiency at 1% and cell edge gains at 4%.

All of the above gains are for FDD networks with cross-polarized antennas at the eNodeBs. For TDD networks, the gains are higher by virtue of being able to invoke channel reciprocity and thus infer the DL channel directly from the UL channel. For example, for intra-eNodeB CoMP with JT 4x2 MU-MIMO, the respective gains in spectral efficiency and cell-edge throughput are 14% and 29%, respectively.

The gains for UL CoMP based on Joint Reception (JR) are greater than the DL gains. For intra-eNodeB CoMP, the average and cell-edge throughputs are increased to 22% and 40%, assuming two receive antenna paths with SU-MIMO. These respective gains increase to 31% and 66% for inter-eNodeB CoMP. In addition, UL CoMP does not require standardization and thus facilitates vendor implementation.

Uplink CoMP assists VoLTE because it improves cell-edge performance, making voice handover more reliable when traversing between cells. The benefit is analogous to CDMA soft handover; in both cases, the mobile device communicates with two sites simultaneously.

## **User-Plane Congestion Management (UPCON)**

With User-Plane Congestion Management, specified in Release 13, operators have additional tools to mitigate network congestion in specific coverage areas. Mechanisms include traffic prioritization by adjusting QoS for specific services; reducing traffic by, for example, compression; and limiting traffic, such as by prohibiting or deferring certain traffic.

---

<sup>277</sup> 3GPP, *Coordinated Multi-Point Operation for LTE Physical Layer Aspects*, TR 36.819 v11.1.0, Tables 7.3.1.2-3 and 7.3.1.2-4, Sep. 2011.

3GPP specifications add a new architectural entity, called the “RAN Congestion Awareness Function” (RCAF), that determines whether a cell is congested, determines the UEs supported by that cell, and informs the Policy Control and Charging Rules Function (PCRF), which can subsequently apply different policies to mitigate the congestion.<sup>278</sup>

### **Network-Assisted Interference Cancellation and Suppression (NAICS)**

NAICS, a Release 13 capability, enhances the interference cancellation and suppression capability of UEs by using more information from the network. The fundamental goal of NAICS is to identify and cancel the dominant interferer, not an easy task when the dominant interferer can be on or off and can change in time and frequency. One analysis estimates an average performance gain of 7.4% relative to Release 11 Interference Rejection Combining and 11.7% at the cell edge.<sup>279</sup> 5G Americas members expect even higher performance gains, for example 20%, with implementation-specific scheduling and as NAICS methods are refined.

### **Multi-User Superposition Transmission (MUST)**

MUST, specified in Release 14, uses simultaneous transmissions of data for more than one UE within a cell without time, frequency, or spatial layer separation. The concept relies on a UE close to the base station having low propagation loss and a UE far from the base station having high propagation loss. The far UE is not aware of, nor interfered by the near UE transmission. The near UE cancels the far UE interference. The capacity gain grows with the SNR/SINR difference between the close and far UEs.

### **IPv4/IPv6**

Release 8 defines support for IPv6 for both LTE and UMTS networks. An Evolved Packet System bearer can carry both IPv4 and IPv6 traffic, enabling a UE to communicate both IPv4 and IPv6 packets (assuming it has a dual stack) while connected through a single EPS bearer. It is up to the operator, however, whether to assign IPv4, IPv6, or both types of addresses to UE.

Communicating between IPv6-only devices and IPv4 endpoints will require protocol-conversion or proxies. For further details, refer to the 5G Americas white paper, “IPv6 – Transition Considerations for LTE and Evolved Packet Core,” February 2009.

### **TDD Harmonization**

3GPP developed LTE TDD to be fully harmonized with LTE FDD including alignment of frame structures, identical symbol-level numerology, the possibility of using similar Reference Signal patterns, and similar synchronization and control channels. Also, there is only one TDD variant. Furthermore, LTE TDD has been designed to co-exist with TD-SCDMA and TD-CDMA/UTRA (both low-chip rate and high-chip rate versions). LTE TDD achieves compatibility and co-existence with TD-SCDMA by defining frame structures in which the DL and UL time periods can be time aligned to prevent BTS to BTS and UE to UE interference to support operation in adjacent carriers without the need for large guardbands between the technologies. This will simplify deployment of LTE TDD in

---

<sup>278</sup> For further details, see 3GPP TR 23.705, *Study on system enhancements for user plane congestion management (Release 13)*.

<sup>279</sup> Harri Holma, Antti Toskala, Jussi Reunanen, *LTE Small Cell Optimization: 3GPP Evolution to Release 13*, Jan 2016, Wiley, ISBN: 978-1-118-91257-7.

countries such as China that are deploying TD-SCDMA. Figure 121 demonstrates the synchronization between TC-SCDMA and LTE-TDD in adjacent channels.

**Figure 121: TDD Frame Co-Existence between TD-SCDMA and LTE TDD<sup>280</sup>**

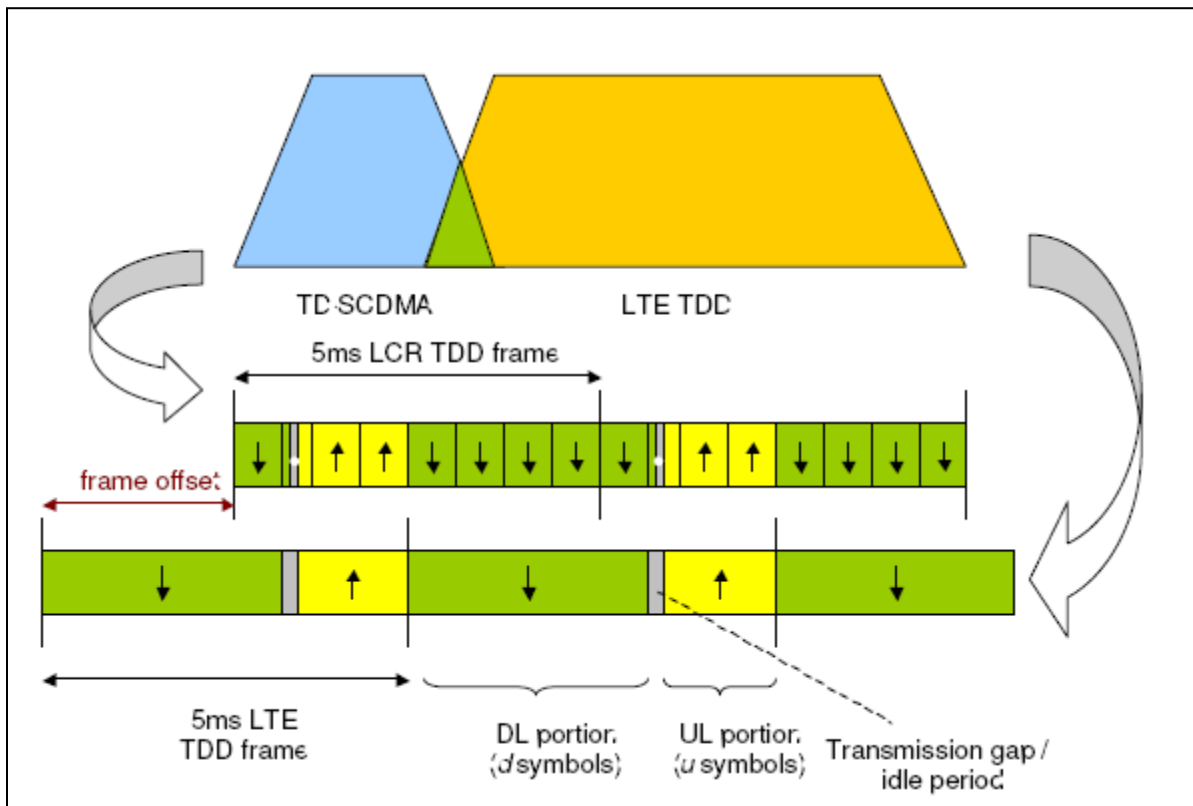

For LTE FDD and TDD to co-exist, large guardbands will be needed to prevent interference.

## SMS in LTE

Even if an LTE network uses CSFB for voice, LTE devices will be able to send and receive SMS messages while on the LTE network. In this case, the 2G/3G core network will handle SMS messaging, but will tunnel the message to the MME in the EPC via the SGs interface. Once an LTE network uses IMS and VoLTE for packet voice service, SMS will be handled as SMS over IP and will use IMS infrastructure.<sup>281</sup>

## User Equipment Categories

LTE specifications define categories of UE, which mainly determine the maximum throughputs of devices but also govern the number of downlink MIMO layers, as shown in Table 34.

<sup>280</sup> 5G Americas member company contribution.

<sup>281</sup> For further details, see 4G Americas, *Coexistence of GSM, HSPA and LTE*, May 2011, 35.



Higher throughput capabilities are possible with 64 QAM and 256 QAM modulation. 3GPP is also defining Category 0 and Category M devices for M2M, as discussed in the section “Internet of Things and Machine to Machine.”

**Table 34: UE Categories<sup>282</sup>**

UE Category	Max DL Throughput	Maximum DL MIMO Layers	Maximum UL Throughput
1	10.3 Mbps	1	5.2 Mbps
2	51.0 Mbps	2	25.5 Mbps
3	102.0 Mbps	2	51.0 Mbps
4	150.8 Mbps	2	51.0 Mbps
5	299.6 Mbps	4	75.4 Mbps
6	301.5 Mbps	2 or 4	51.0 Mbps
7	301.5 Mbps	2 or 4	102.0 Mbps
8	2998.6 Mbps	8	1497.8 Mbps
9	452.3 Mbps	2 or 4	51.0 Mbps
10	452.3 Mbps	2 or 4	102.0 Mbps
11	603.0 Mbps	2 or 4	51.0 Mbps
12	603.0 Mbps	2 or 4	102.0 Mbps
13	391.6 Mbps	2 or 4	150.8 Mbps
14	3916.6 Mbps	8	9587.7 Mbps
15	798.8 Mbps	2 or 4	226.1 Mbps
16	1051.4 Mbps	2 or 4	105.5 Mbps
17	2506.6 Mbps	8	2119.4 Mbps
18	1206.0 Mbps	2 or 4 (or 8)	211.0 Mbps
19	1658.3 Mbps	2 or 4 (or 8)	13563.9 Mbps
20	2019.4 Mbps	2 or 4 (or 8)	316.6 Mbps
21	1413.1 Mbps	2 or 4	301.5 Mbps

<sup>282</sup> 3GPP, Evolved Universal Terrestrial Radio Access (E-UTRA); *User Equipment (UE) radio access capabilities*, 3GPP 36.306 V15.0.0 (2018-03).

## LTE-Advanced Relays

Another capability being planned for LTE-Advanced is relays, as shown in Figure 122. The idea is to relay frames at an intermediate node, resulting in much better in-building penetration, and with better signal quality, user rates will improve. Relay nodes can also improve cell-edge performance by making it easier to add picocells at strategic locations.

Relays provide a means for lowering deployment costs in initial deployments in which usage is relatively low. As usage increases and spectrum needs to be allocated to access only, operators can then employ alternate backhaul schemes.

**Figure 122: LTE-Advanced Relay<sup>283</sup>**

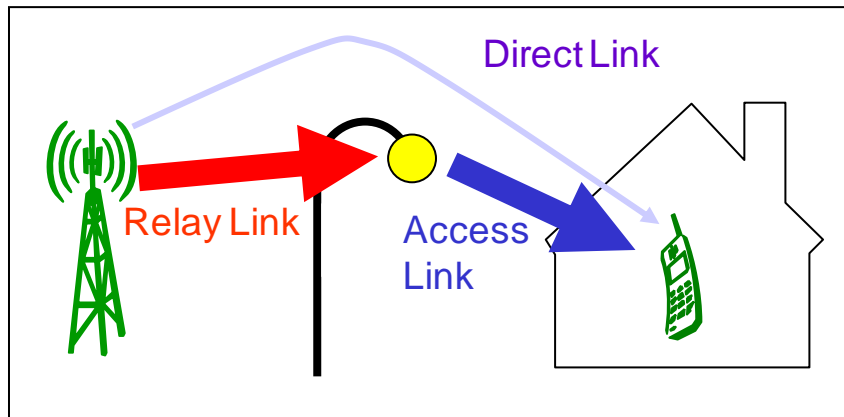

## Proximity Services (Device-to-Device)

Release 12 defined a capability for devices to communicate directly with one another using LTE spectrum, a feature also called "operator-enabled proximity services." With this capability, devices can autonomously discover nearby relevant devices and services in a battery-efficient manner. Devices broadcast their needs and services and can also passively identify services without user intervention. The communication between devices is called "sidelink communications" and uses an interface called "PC5." Release 12, emphasizing public-safety applications, supports only one-to-many sidelink communications, whereas Release 13 supports one-to-one sidelink communications between two group member UEs and between a remote UE and a relay UE.

Initial emphasis of this capability, in both Release 12 and Release 13, is on public safety. Examples of potential consumer or commercial applications include discovering friends and family (social matching), push advertising for relevant notifications, tourist bulletins, venue services, crime alerts, home automation, vehicle-to-vehicle communication, and detecting children leaving the vicinity of their homes. The service is designed to work during infrastructure failures, even in emergencies and natural disasters. As a new means of communicating, proximity services could result in innovative types of applications.

The LTE network performs configuration and authentication; however, communication can be either via the network or directly between devices. To minimize battery consumption, devices synchronously wake up for brief intervals to discover services. The impact on LTE network capacity is minimal.

---

<sup>283</sup> 5G Americas member contribution.

As with other location-based services, operators and application developers will need to address privacy concerns.

## LTE Throughput

The section “4G LTE Advances” above in the main section of the paper and “Data Throughput Comparison” in the appendix provide an overview of LTE throughputs. This section provides additional details.

Table 35 shows initial (Release 8) LTE peak data rates based on different downlink and uplink designs.

**Table 35: LTE Peak Throughput Rates**

LTE Configuration	Downlink (Mbps) Peak Data Rate	Uplink (Mbps) Peak Data Rate
Using 2X2 MIMO in the Downlink and 16 QAM in the Uplink, 10+10 MHz	70.0	22.0
Using 4X4 MIMO in the Downlink and 64 QAM in the Uplink, 20+20 MHz	300.0	71.0

LTE is not only efficient for data but, because of a highly efficient uplink, is extremely efficient for VoIP traffic. As discussed in the “Spectral Efficiency” section above, in 10+10 MHz of spectrum, LTE VoIP capacity will reach 500 users.<sup>284</sup>

Table 36 analyzes LTE median and average throughput values in greater detail for different LTE configurations.

---

<sup>284</sup> 3GPP Multi-member analysis.

**Table 36: LTE FDD User Throughputs Based on Simulation Analysis<sup>285</sup>**

Configuration	User Throughput, Mbps			
	Downlink (DL)		Uplink (UL)	
	Median	Average	Median	Average
LTE FDD: Low Band, 2x2 MIMO-DL, 1x2 SIMO-UL, 10+10 MHz, R8	8.6	10.9	4.5	5.0
LTE FDD: High Band, 4x2 MIMO-DL, 1x4 SIMO-UL, 10+10 MHz, R8	10.6	12.2	5.4	6.4
LTE FDD: High Band, 2x2 MIMO-DL, 1x2 SIMO UL, 20+20 MHz, R8	15.2	17.9	5.4	7.0
LTE FDD: High Band, 4x4 MIMO-DL, 1x4 SIMO UL, 20+20 MHz, R12	25.4	29.2	6.9	9.1

The simulation results represent a consensus view of 5G Americas members working on this white paper project. The goal of the analysis was to quantify LTE throughputs in realistic deployments. Simulation assumptions include:

- ❑ Traffic is FTP-like at a 50% load with a 75/25 mix of indoor/outdoor users.
- ❑ Throughput is at the medium-access control (MAC) protocol layer. (Application-layer throughputs may be 5 to 8 percent lower due to protocol overhead.)
- ❑ The 3GPP specification release numbers shown correspond to the infrastructure capability.
- ❑ The configuration in the first row corresponds to low-frequency band operation, representative of 700 MHz or cellular, while the remaining configurations assume high-frequency band operation, representative of PCS, AWS, or WCS. (Higher frequencies facilitate higher-order MIMO configurations and have wider radio channels available.)
- ❑ The downlink value for the first row corresponds to Release 8 device-receive capability (Minimum Mean Square Error [MMSE]), while the values in the other rows correspond to Release 11 device-receive capability (MMSE – Interference Rejection Combining [IRC]).
- ❑ The uplink value for the first row corresponds to a Maximal Ratio Combining (MRC) receiver at the eNodeB, while the remaining values correspond to an IRC receiver.
- ❑ Low-band operation assumes 1,732-meter inter-site distance, while high-band operation assumes 500-meter ISD. The remaining simulation assumptions are listed in Table 37.

---

<sup>285</sup> 5G Americas member contribution. SIMO refers to Single Input Multiple Output antenna configuration, which in the uplink means one transmit antenna at the UE and multiple receive antennas at the eNodeB.

**Table 37: LTE FDD User Throughput Simulation Assumptions<sup>286</sup>**

Parameter	Value
Frequency	Low Band (LB): B17; High Band (HB): B30
Channel bandwidth	10 MHz, 20 MHz
System configuration	DL: 2x2, 4x2, and 4x4 Closed-Loop (CL) MIMO UL: 1x2 and 1x4 SIMO
Traffic type	FTP model 2: File size = 0.15 Mbyte, 1 second inter-arrival time, Load varied by changing number of users
Inter-Site Distance (ISD)	LB: 1732 m; HB: 500 m
Pathloss model	LB: HATA; HB: COST231 with correction
eNodeB transmit power	LB: 60 watts total; HB: 80 watts total
eNodeB antenna type	2 Tx = +45 degrees cross-pol (DIV-1X); 4 Tx = Closely separated pair of cross-pols (CLA-2X)
eNodeB antenna gain	LB: 14.8 dBi; HB: 17.5 dBi
eNodeB antenna pattern	Actual antenna patterns as used in RF planning tool
eNodeB Rx type	LB: MRC; HB: IRC
Downtilt	LB: 7 degrees; HB: 9 degrees
Penetration loss	75/25 mix of indoor/outdoor users LB: 12 dB for indoor users; HB: 22 dB for indoor users
Device speed	3 km/h all users
Channel model	Modified SCME-WINNER+, LB: Suburban Macro (SMa) scenario; HB: Urban Macro (UMa)
Device antenna type	+45 degrees cross-pol with built in correlation of 0.5
Device antenna gain and mismatch	LB: -5 dBi and 3 dB; HB: -3 dBi and 3 dB
Device body loss	3 dB for both bands
Device Rx type	MMSE, MMSE-IRC
Uplink power control	LB: alpha = 1, Po = -100 dBm; HB: alpha = 0.9, Po = -100 dBm
Scheduler	Proportional fair, frequency selective

The assumptions, emphasizing realistic deployments, do not necessarily match assumptions used by other organizations, such as 3GPP, so results may differ.

Additional insight into LTE performance under different configuration comes from a test performed on a cluster of cells in an LTE operator's network, comparing downlink performance of 4X2 MIMO against 2X2 MIMO, and uplink performance of 1X4 SIMO against 1X2 SIMO. The test employed LTE category 4 devices.<sup>287</sup>

<sup>286</sup> 5G Americas member contribution.

<sup>287</sup> 5G Americas member contribution.

These tests, which were performed in a 20+20 MHz cluster, show significant improvements in cell edge uplink and downlink throughput, in addition to an overall increase in uplink and downlink throughputs. Specific results include:

- ❑ A 100% increase in uplink throughput at the cell edge with 1X4 SIMO compared to 1x2 SIMO.
- ❑ A 40% increase in downlink throughput at the cell edge with 4x2 closed-loop MIMO compared to 2x2 open-loop MIMO.
- ❑ A 50 to 75% increase in downlink throughput with closed loop MIMO compared to transmit diversity modes.
- ❑ Up to 6dB gains in uplink transmit power with 1X4 SIMO, which directly translates into UE battery savings.
- ❑ Peak speeds of 144 Mbps with 4X2 MIMO in the downlink and 47 Mbps with 1X4 SIMO in the uplink.

Another LTE operator's testing results for LTE in a TDD configuration, using 20 MHz channels, 3:2 DL to UL ratio, and category 3 devices, showed:

- ❑ Peak speeds of 55 Mbps.
- ❑ Typical speeds of 6 to 15 Mbps.<sup>288</sup>

Figure 123 shows the result of a drive test in a commercial LTE network with a 10 MHz downlink carrier demonstrating 20 Mbps to 50 Mbps throughput rates across much of the coverage area. Throughput rates would double with a 20+20 MHz configuration.

---

<sup>288</sup> 5G Americas member contribution.

**Figure 123: Drive Test of Commercial European LTE Network (10+10 MHz)<sup>289</sup>**

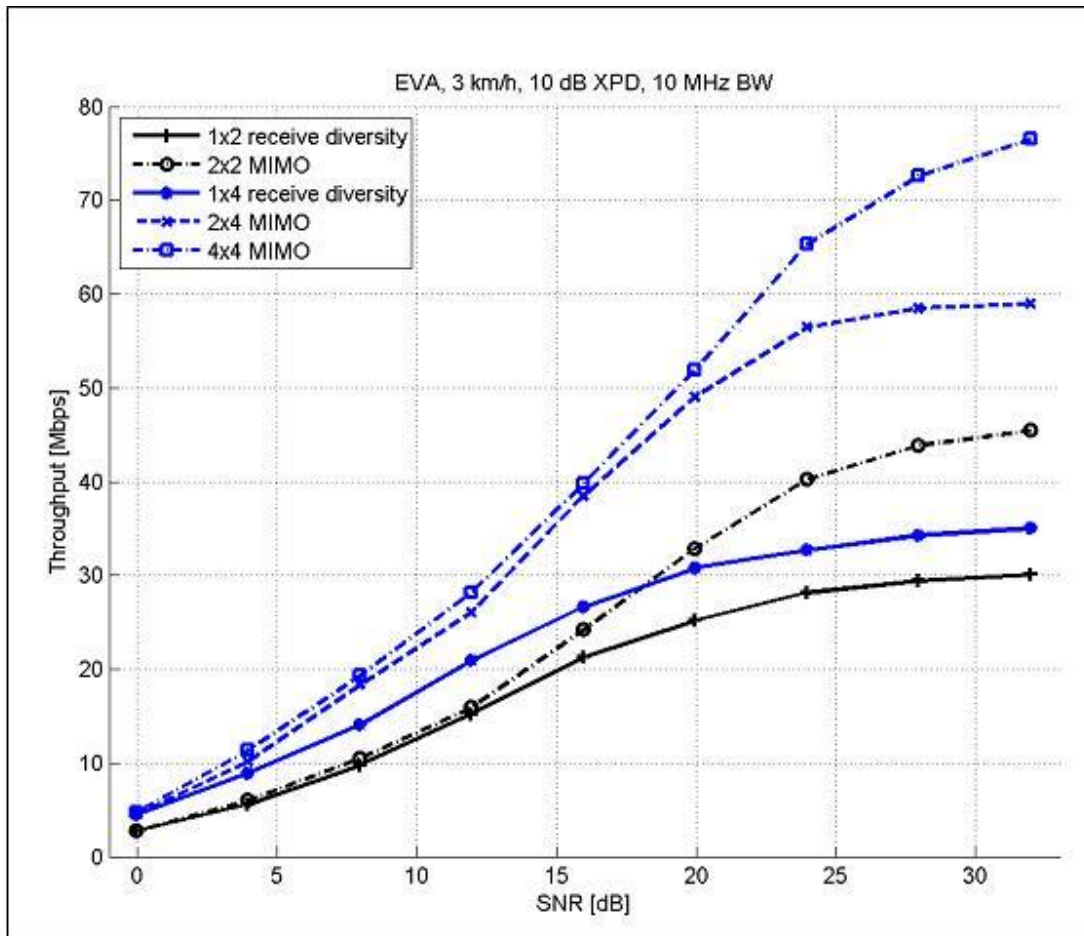

Figure 124 provides additional insight into LTE downlink throughput, showing Layer 1 throughput simulated at 10 MHz bandwidth using the Extended Vehicular A 3 km/hour channel model. The figure shows the increased performance obtained with the addition of different orders of MIMO. Note how throughput improves based on higher signal to noise ratio (SNR).

---

<sup>289</sup> Ericsson contribution.

**Figure 124: LTE Throughput in Various Modes<sup>290</sup>**



Actual throughput rates that users experience are lower than the peak rates and depend on a variety of factors:

- ❑ **RF Conditions and User Speed.** Peak rates depend on optimal conditions. Suboptimal conditions include being at the edge of the cell or moving at high speed, resulting in lower throughput.
- ❑ **Network Loading.** Like all wireless systems, throughput rates go down as more devices simultaneously use the network. Throughput degradation is linear.

Figure 125 shows how dramatically throughput rates can vary by number of active users and radio conditions. The higher curves are for better radio conditions.

<sup>290</sup> Jonas Karlsson, Mathias Refback, "Initial Field Performance Measurements of LTE," *Ericsson Review*, No. 3, 2008.



**Figure 125: LTE Actual Throughput Rates Based on Conditions<sup>291</sup>**

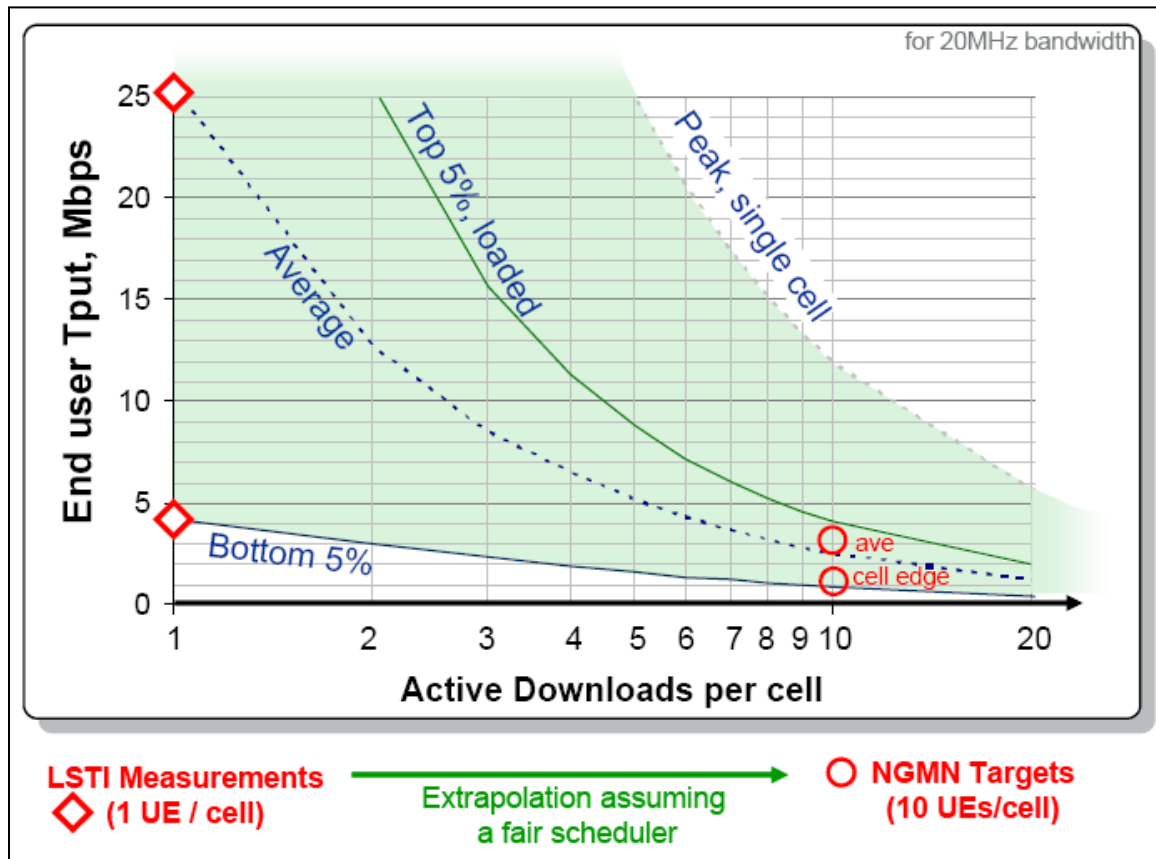

## VoLTE and RCS

This paper introduced VoLTE and voice support in the earlier section, “VoLTE, RCS, WebRTC, and Wi-Fi Calling.” This section in the appendix provides additional technical detail about the operation of VoLTE and RCS.

Voice in LTE can encompass: no voice support, voice implemented in a circuit-switched fallback (CSFB) mode using 2G or 3G, and VoIP implemented with IMS.

Initial LTE network deployments used CSFB, with which the LTE network carries circuit-switched signaling over LTE interfaces, allowing the subscriber to be registered with the 2G/3G MSC even while on the LTE network. When there is a CS event, such as an incoming voice call, the MSC sends the page to the LTE core network, which delivers it to the subscriber device. The device then switches to 2G/3G operation to answer the call.

Voice over LTE using VoIP requires IMS infrastructure. To facilitate IMS-based voice, vendors and operators created the One Voice initiative to define required baseline functionality for user equipment, the LTE access network, the Evolved Packet Core, and the IMS. GSMA adopted the One Voice initiative in what it calls VoLTE, specified in GSMA

<sup>291</sup> LTE/SAE Trial Initiative, “Latest Results from the LSTI, Feb 2009,” <http://www.lstiforum.org>.

reference document IR.92.<sup>292</sup> GSMA specifies interconnection and international roaming among LTE networks through the IR.88<sup>293</sup> specification. Another specification, IR.94, provides the IMS Profile for Conversational Video Service, a service referred to as “Video over LTE” (ViLTE).<sup>294</sup>

For a phone to support VoLTE, it needs software implementing the IMS protocol stack. For example, the iPhone 6 was the first iPhone to implement such software. Additional software implementing RCS application programming interfaces can provide applications with access to IMS-based services, such as voice, messaging, and video. The Open Mobile Alliance has defined RESTful network APIs for RCS that support the following functions: notification channel, chat, file transfer, third-party calls, call notification, video sharing, image sharing, and capability discovery. As shown in Figure 126, over time, new profile releases will broaden the scope of these APIs.

**Figure 126: Evolution of RCS API Profiles<sup>295</sup>**

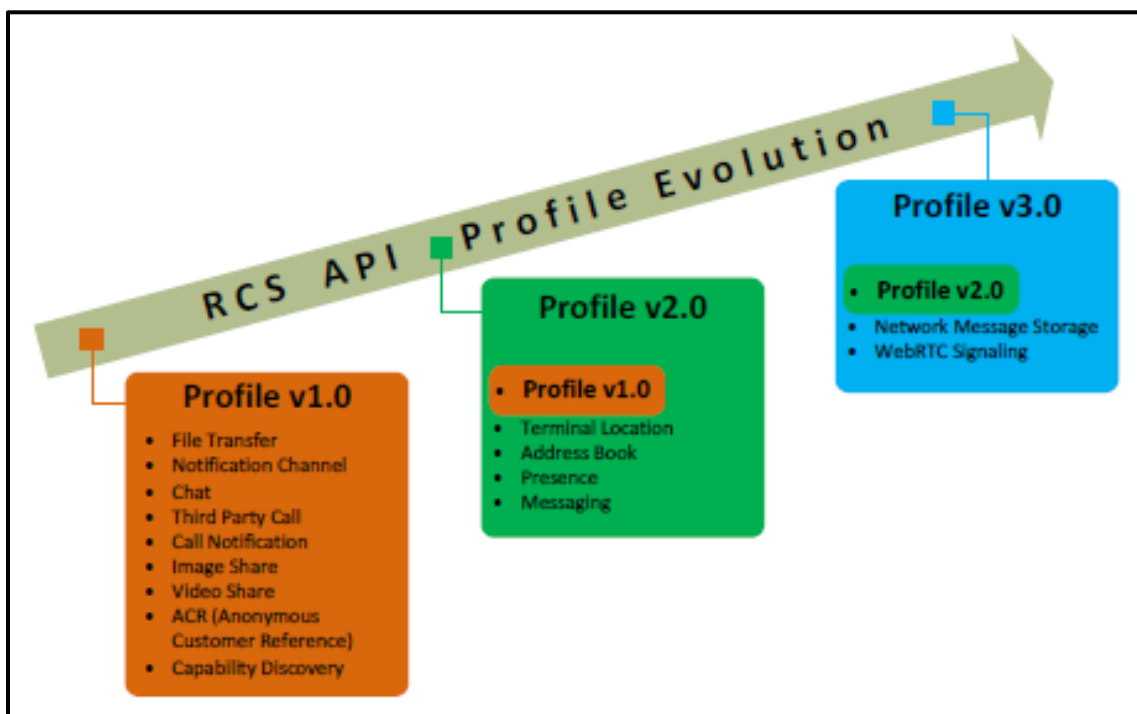

LTE VoIP leverages the QoS capabilities defined for EPC, which specify different quality classes. Features available in LTE to make voice operation more efficient include Semi-Persistent Scheduling (SPS) and TTI bundling. SPS reduces control channel overhead for applications (like VoIP) that require a persistent radio resource. Meanwhile, TTI bundling

<sup>292</sup> GSMA, “IMS Profile for Voice and SMS,” Document IR.92. <http://www.gsma.com/newsroom/wp-content/uploads/2013/04/IR.92-v7.0.pdf>.

<sup>293</sup> GSMA, “LTE Roaming Guidelines,” GSMA Document IR.88. <http://www.gsma.com/newsroom/wp-content/uploads/2013/04/IR.88-v9.0.pdf>.

<sup>294</sup> GSMA, “IMS Profile for Conversational Video Service,” Document IR.94. <http://www.gsma.com/newsroom/all-documents/ir-94-ims-profile-for-conversational-video-service/>.

<sup>295</sup> 4G Americas, VoLTE and RCS Technology – Evolution and Ecosystem, Nov. 2014.

improves subframe utilization by reducing IP overhead, while in the process optimizing uplink coverage.

Another way to increase voice capacity in LTE and to support operation in congestion situations is vocoder rate adaptation, a mechanism with which operators can control the codec rate based on network load, thus dynamically trading off voice quality against capacity.

VoLTE roaming across operators will require network-to-network interfaces between their respective IMS networks. Such roaming and interconnect will follow initial VoLTE deployments. Different IMS stack implementations between vendors will also complicate roaming.

One roaming consideration is how operators handle data roaming. LTE roaming can send all visited network traffic back to the home network, which for a voice call, increases voice latency. For voice calls, the local breakout option would mitigate this latency.

Using Single-Radio Voice Call Continuity (SR-VCC) and Enhanced SR-VCC (eSRVCC), user equipment can switch mid-call to a circuit-switched network, in the event that the user moves out of LTE coverage. Similarly, data sessions can be handed over in what is called "Packet-Switched Handover" (PSHO).

Figure 127 shows how an LTE network might evolve in three stages. Initially, LTE performs only data service, and the underlying 2G/3G network provides voice service via CSFB. In the second stage, voice over LTE is available, but LTE covers only a portion of the total 2G/3G coverage area. Hence, voice in 2G/3G can occur via CSFB or SR-VCC. Eventually, LTE coverage will match 2G/3G coverage, and LTE devices will use only the LTE network.

**Figure 127: Evolution of Voice in an LTE Network<sup>296</sup>**

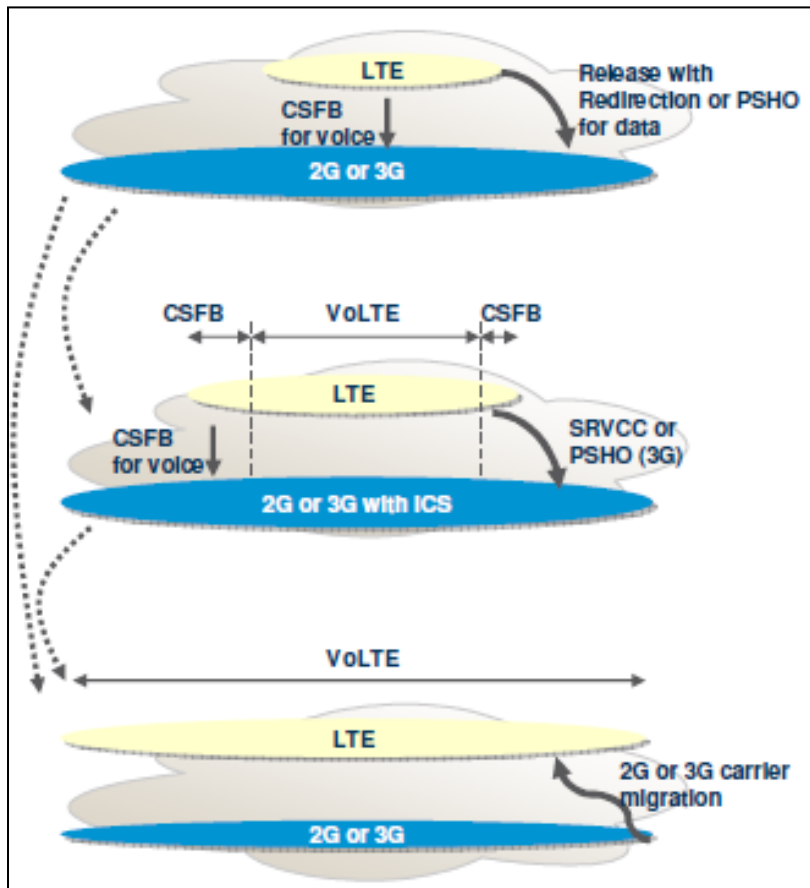

Another voice approach, called "Voice over LTE via Generic Access" (VoLGA), defined circuit-switched operation through an LTE IP tunnel. 3GPP, however, has stopped official standards work that would support VoLGA.

3GPP has developed a new codec, called "Enhanced Voice Services" (EVS), which will include super-wideband voice capability. For the same bit rate, EVS provides higher voice quality than the other codecs.<sup>297</sup> Table 38 summarizes the features and parameters of the three 3GPP codecs used in LTE.

<sup>296</sup> 5G Americas member contribution.

<sup>297</sup> See Figure 9.2. 3GPP, TR 26.952 V12.1.0, Codec for Enhanced Voice Services (EVS); Performance Characterization, Mar. 2015.

**Table 38: Comparison of AMR, AMR-WB and EVS Codecs<sup>298</sup>**

Features	AMR	AMR-WB	EVS
Input and output sampling frequencies supported	8KHz	16KHz	8KHz, 16KHz, 32KHz, 48 KHz
Audio bandwidth	Narrowband	Wideband	Narrowband, Wideband, Super-wideband, Fullband
Coding capabilities	Optimized for coding human voice signals	Optimized for coding human voice signals	Optimized for coding human voice and general-purpose audio (music, ringtones, mixed content) signals
Bit rates supported (in kb/s)	4.75, 5.15, 5.90, 6.70, 7.4, 7.95, 10.20, 12.20	6.6, 8.85, 12.65, 14.25, 15.85, 18.25, 19.85, 23.05, 23.85	5.9, 7.2, 8, 9.6 (NB and WB only), 13.2 (NB, WB and SWB), 16.4, 24.4, 32, 48, 64, 96, 128 (WB and SWB only)
Number of audio channels	Mono	Mono	Mono and Stereo
Frame size	20 ms	20 ms	20 ms
Algorithmic Delay	20-25 ms	25 ms	Up to 32 ms

Figure 128 shows mean opinion scores (MOS) for different codecs at different bit rates, illustrating the advantage of EVS, particularly for bit rates below 32 kbps that cellular networks use.

<sup>298</sup> 4G Americas, *Mobile Broadband Evolution: Rel-12 & Rel-13 and Beyond*, 2015. See also T-Mobile 2016 EVS announcement: <https://newsroom.t-mobile.com/news-and-blogs/volte-enhanced-voice-services.htm>.

**Figure 128: Combined Mean Opinion Score Values<sup>299</sup>**

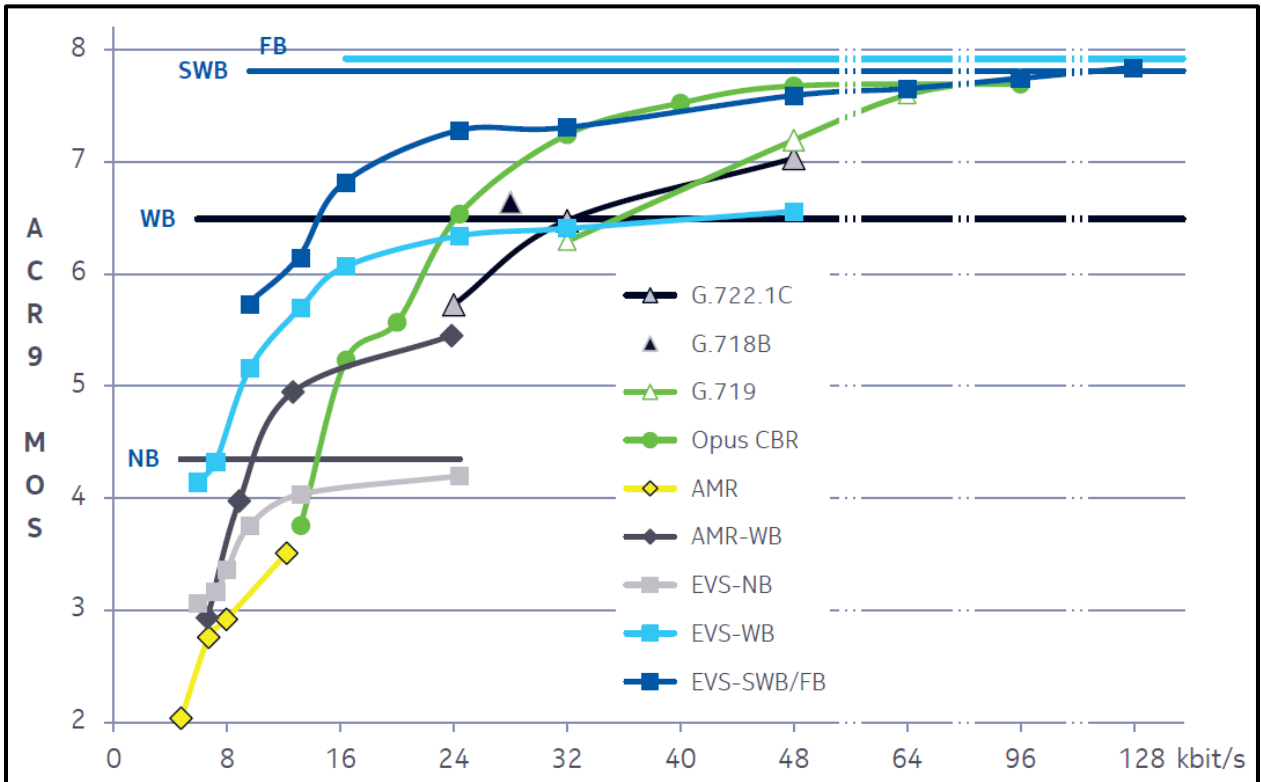

Table 39 shows EVS (narrowband, wideband, super-wideband) audio bandwidths and bitrates that create subjective quality equal to or better than AMR or AMR-WB for typical conversational voice scenarios.

**Table 39: EVS Compared to AMR and AMR-WB<sup>300</sup>**

Reference	Equal bandwidth	Wider bandwidth
AMR 12.2 kbit/s	EVS-NB 8.0 kbit/s	EVS-WB 5.9 kbit/s
AMR-WB 12.65 kbit/s	EVS-WB 9.6 kbit/s	EVS-SWB 9.6 kbit/s
AMR-WB 23.85 kbit/s	EVS-WB 13.2 kbit/s	EVS-SWB 9.6 kbit/s

Figure 129 compares EVS capacity gains over AMR and AMR-WB for the reference cases shown in Table 39. EVS-SWB at 9.6 kbps almost doubles voice capacity compared to AMW-WB at 23.85 kbps.

<sup>299</sup> Nokia, The 3GPP Enhanced Voice Services (EVS) codec, 2015.

<sup>300</sup> Ibid.

**Figure 129: EVS Voice Capacity Compared to AMR and AMR-WB<sup>301</sup>**

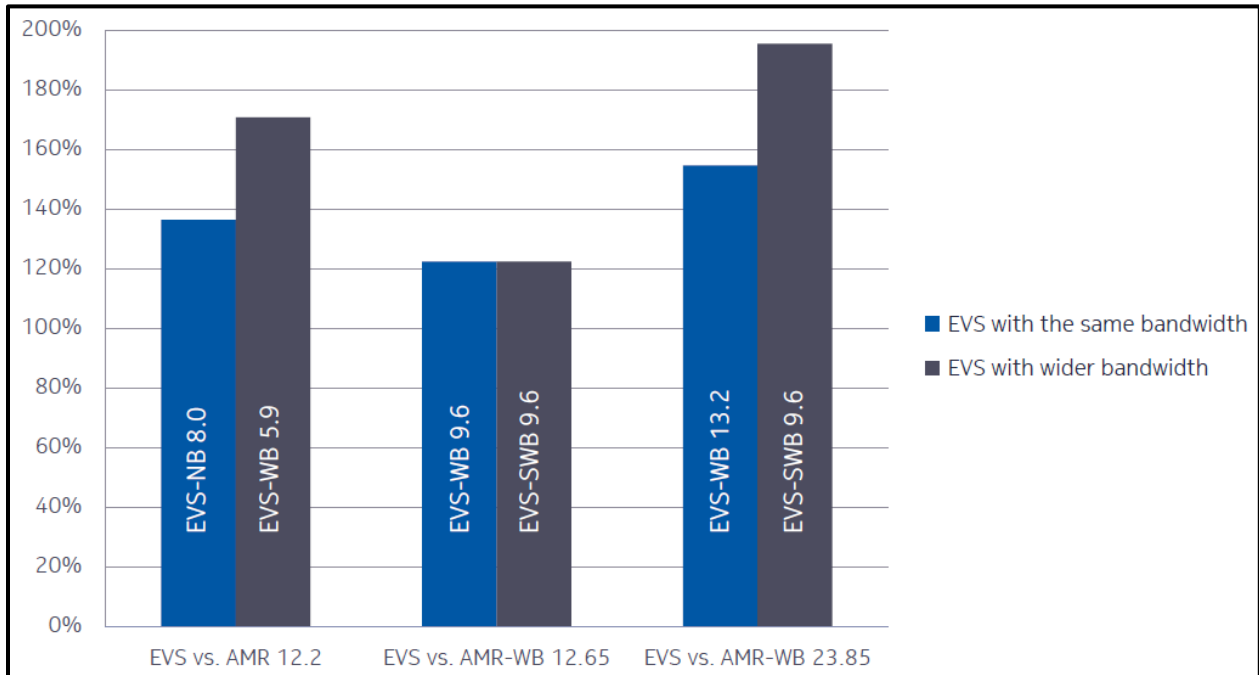

### **LTE Ultra-Reliable and Low-Latency Communications**

The 3GPP work item for this feature states, "3GPP LTE technology enhancements are needed to serve such new use cases and to remain technologically competitive up to and beyond 2020. As a candidate technology for ITU IMT-2020 submission, it is motivated to further enhance the LTE system such that it can meet the key IMT-2020 requirements including those for URLLC in terms of reliability ( $1-10^{-5}$  reliability for small data packets within a latency of 1ms) as well as latency ( $\leq 1\text{ms}$  one way user plane latency)."<sup>302</sup>

### **Evolved Packet Core (EPC)**

3GPP defined the Evolved Packet Core (EPC) in Release 8 as a framework for an evolution or migration of the network to a higher-data-rate, lower latency, packet-optimized system that supports multiple radio-access technologies including LTE, as well as and legacy GSM/EDGE and UMTS/HSPA networks. EPC also integrates CDMA2000 networks and Wi-Fi.

EPC is optimized for all services to be delivered via IP in a manner that is as efficient as possible—through minimization of latency within the system, for example. It also provides service continuity across heterogeneous networks, which is important for LTE operators who must simultaneously support GSM-HSPA customers.

One important performance-enhancing aspect of EPC is a flatter architecture. For packet flow, EPC includes two network elements, called "Evolved Node B" (eNodeB) and the Access Gateway (AGW). The eNodeB (base station) integrates the functions traditionally

<sup>301</sup> Ibid.

<sup>302</sup> RP-170796, 3GPP Work Item Description, "Ultra Reliable Low Latency Communication for LTE," Mar. 2017.

performed by the radio network controller, which previously was a separate node controlling multiple Node Bs. Meanwhile, the AGW integrates the functions traditionally performed by the SGSN and GGSN. The AGW includes both control functions, handled through the Mobile Management Entity (MME), and user plane (data communications) functions. The user plane functions consist of two elements: A serving gateway that addresses 3GPP mobility and terminates eNodeB connections, and a Packet Data Network (PDN) gateway that addresses service requirements and also terminates access by non-3GPP networks. The MME serving gateway and PDN gateways can be collocated in the same physical node or distributed, based on vendor implementations and deployment scenarios.

EPC uses IMS as a component. It also manages QoS across the whole system, an important enabler for voice and other multimedia-based services.

Figure 130 shows the EPC architecture.

**Figure 130: EPC Architecture**

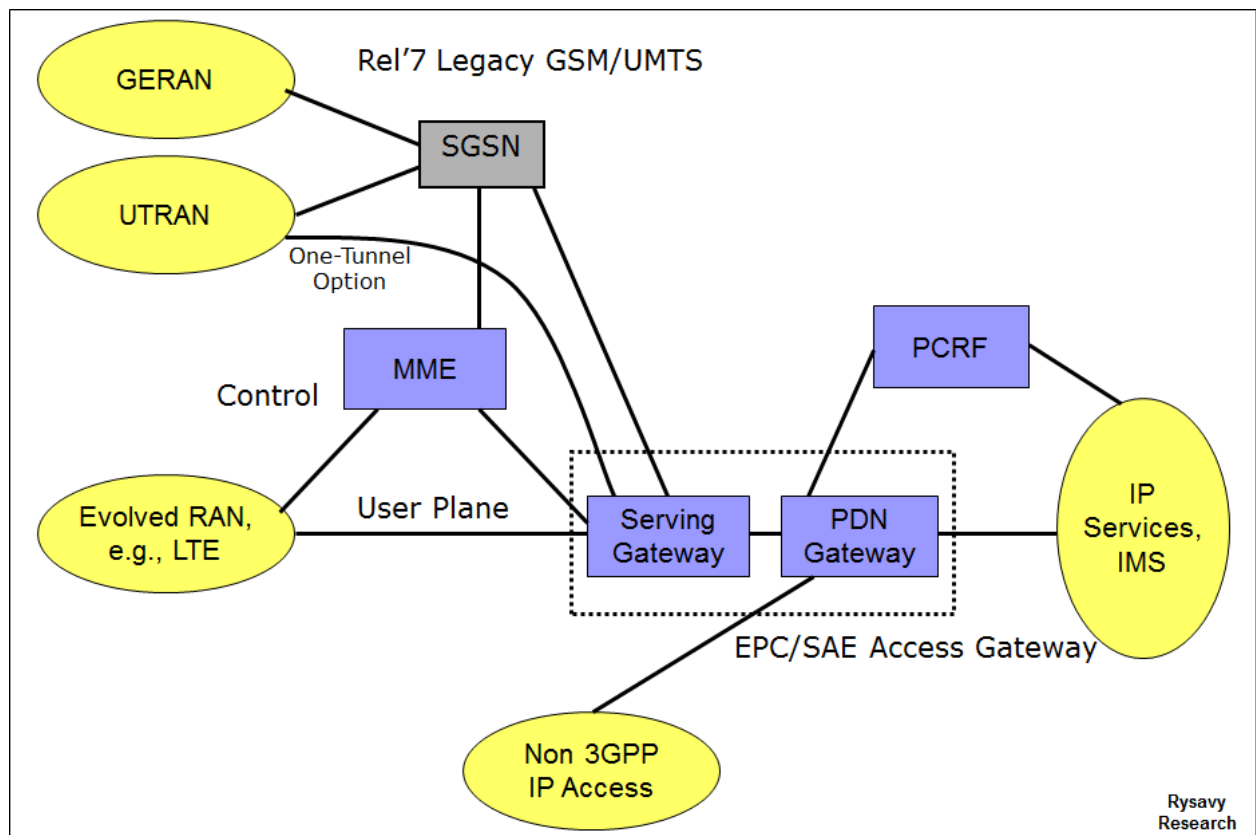

Elements of the EPC architecture include:

- ❑ Support for legacy GERAN and UTRAN networks connected via SGSN.
- ❑ Support for new radio-access networks such as LTE.
- ❑ Support for non-3GPP networks such as EV-DO and Wi-Fi. (See section below on Wi-Fi integration).
- ❑ The Serving Gateway that terminates the interface toward the 3GPP radio-access networks.



- ❑ The PDN gateway that controls IP data services, does routing, allocates IP addresses, enforces policy, and provides access for non-3GPP access networks.
- ❑ The MME that supports user equipment context and identity, as well as authenticating and authorizing users.
- ❑ The Policy Control and Charging Rules Function that manages QoS aspects.

QoS in EPS employs the QoS Class Identifier (QCI), a number denoting a set of transport characteristics (bearer with/without guaranteed bit rate, priority, packet delay budget, packet error loss rate) and used to infer nodes specific parameters that control packet forwarding treatment (such as scheduling weights, admission thresholds, queue management thresholds, or link-layer protocol configuration). The network maps each packet flow to a single QCI value (nine are defined in the Release 8 version of the specification) according to the level of service required by the application. Use of the QCI avoids the transmission of a full set of QoS-related parameters over the network interfaces and reduces the complexity of QoS negotiation. The QCI, together with Allocation Retention Priority (ARP) and, if applicable, Guaranteed Bit Rate (GBR) and Maximum Bit Rate (MBR), determines the QoS associated to an EPS bearer. A mapping between EPS and pre-Release 8 QoS parameters permits interworking with legacy networks.

The QoS architecture in EPC enables a number of important capabilities for both operators and users:

- ❑ **VoIP support with IMS.** QoS is a crucial element for providing LTE/IMS voice service. (See section below on IMS).
- ❑ **Enhanced application performance.** Applications such as gaming or video can operate more reliably.
- ❑ **More flexible business models.** With flexible, policy-based charging control, operators and third parties will be able to offer content in creative new ways. For example, an enhanced video stream to a user could be paid for by an advertiser.
- ❑ **Congestion control.** In congestion situations, certain traffic flows (bulk transfers, abusive users) can be throttled down to provide a better user experience for others.

Table 40 shows the initial QCIs defined for LTE.<sup>303</sup>

**Table 40: LTE Quality of Service**

QCI	Resource Type	Priority	Delay Budget	Packet Loss	Examples
1	GBR (Guaranteed Bit Rate)	2	100 msec.	$10^{-2}$	Conversational voice
2	GBR	4	150 msec.	$10^{-3}$	Conversational video (live streaming)
3	GBR	3	50 msec.	$10^{-3}$	Real-time gaming

<sup>303</sup> For a comprehensive, up-to-date list of QCI, refer to 3GPP, *Policy and charging control architecture*, 3GPP TS 23.203. <https://portal.3gpp.org/desktopmodules/Specifications/SpecificationDetails.aspx?specificationId=810>.

QCI	Resource Type	Priority	Delay Budget	Packet Loss	Examples
4	GBR	5	300 msec.	$10^{-6}$	Non-conversational video (buffered streaming)
5	Non-GBR	1	100 msec.	$10^{-6}$	IMS signaling
6	Non-GBR	6	300 msec.	$10^{-6}$	Video (buffered streaming), TCP Web, email, and FTP
7	Non-GBR	7	100 msec.	$10^{-3}$	Voice, video (live streaming), interactive gaming
8	Non-GBR	8	300 msec.	$10^{-6}$	Premium bearer for video (buffered streaming), TCP Web, e-mail, and FTP
9	Non-GBR	9	300 msec.	$10^{-6}$	Default bearer for video, TCP for non-privileged users

## ***Heterogeneous Networks and Small Cells***

A fundamental concept in the evolution of next-generation networks is the blending of multiple types of networks to create a “network of networks” characterized by:

- ❑ Variations in coverage areas, including femtocells (either enterprise femtos or home femtos, called HeNBs), picocells (also referred to as metro cells), and macro cells. Cell range can vary from 10 meters to 50 kilometers.
- ❑ Different frequency bands.
- ❑ Different technologies spanning Wi-Fi, 2G, 3G, 4G, and 5G.
- ❑ Relaying capability in which wireless links can serve as backhaul.

Figure 131 shows how user equipment might access different network layers.

**Figure 131: Load Balancing with Heterogeneous Networks<sup>304</sup>**

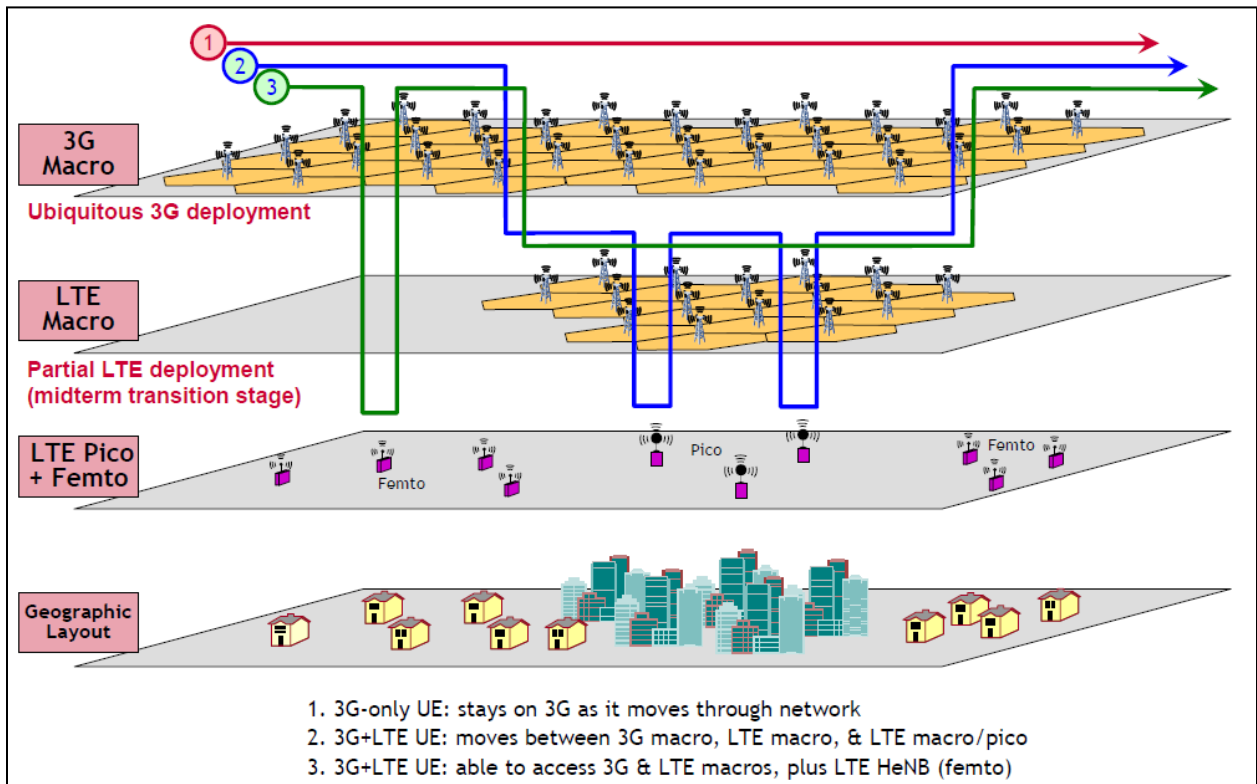

HetNets will allow significant capacity expansion in configurations in which operators can add picocells to coverage areas served by macrocells, particularly if there are hot spots with higher user densities.

Small cells differentiate themselves from macrocells according to the parameters shown in Table 41.

**Table 41: Small Cell Vs. Macro Cell Parameters: Typical Values**

Parameter	Small Cell	Macro Cell
Transmission Power	24 dBm (0.25 W)	43 dBm (20 W)
Antenna Gain	2 dBi	15 dBi
Users	Tens	Hundreds
Mobility	30 km/hr	350 km/hr

Whether or not the small cell uses the same radio carriers as the macro cell involves multiple tradeoffs. In Figure 132 Scenario 1, the small cells and macro cell use different

<sup>304</sup> 5G Americas member contribution.

radio carriers, the two not interfering with each other. Although this configuration requires more spectrum, the small cells are able to cover larger areas than if they were deployed using the same radio carrier as the macro. This configuration supports medium-to-high penetration levels of small cells, allowing the network to reach huge capacity.

In Scenario 2, the small cells and macro cells use the same radio carrier, accommodating operators with more limited spectrum, but the network must manage interference using the techniques discussed below. Operators must carefully manage small-cell transmission power in this configuration.

**Figure 132: Scenarios for Radio Carriers in Small Cells**

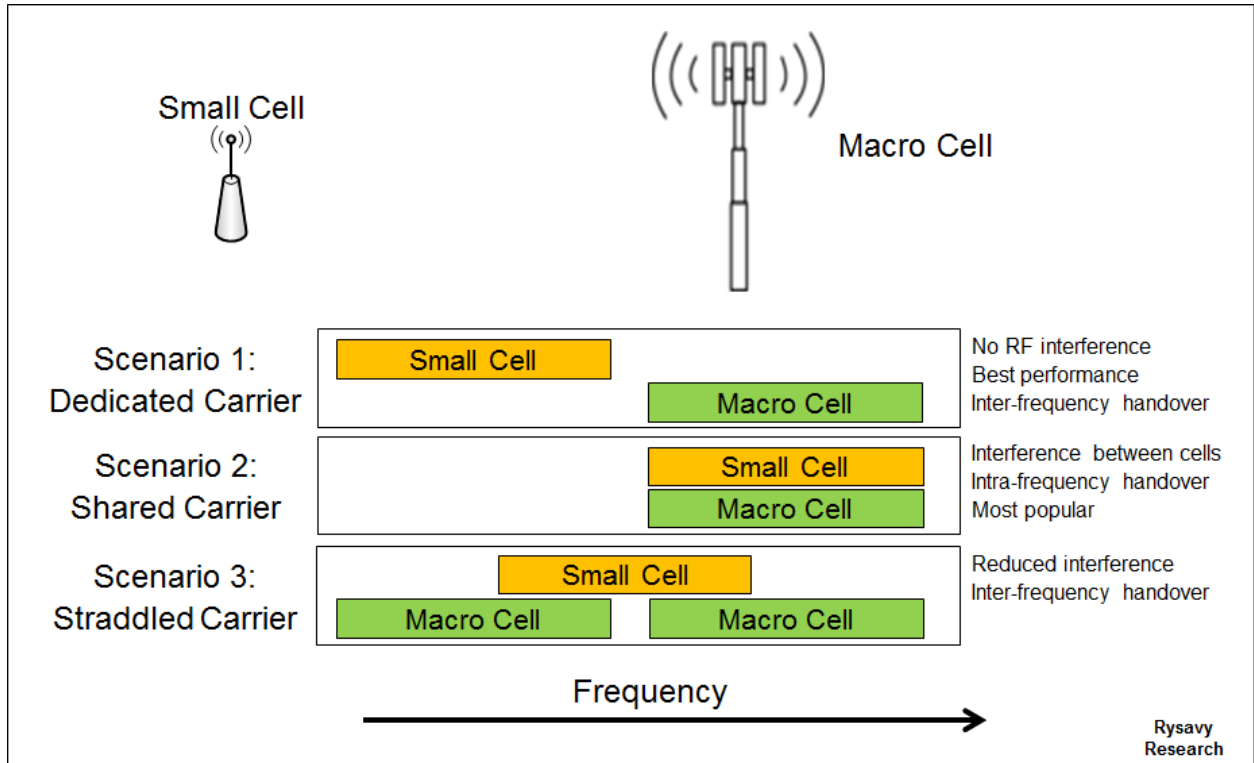

In Scenario 3, the small cells use a straddled radio carrier, accommodating operators with more spectrum, but the network still needs to manage interference using techniques discussed below. Compared with a shared carrier configuration, this configuration has benefits similar to dedicated carriers in terms of radio-parameter planning and reduced interference.

Figure 133 shows two different traffic distribution scenarios, with a uniform distribution of devices in the first and higher densities serviced by picocells in the second. The second scenario can result in significant capacity gains as well as improved user throughput.

**Figure 133: Different Traffic Distributions Scenarios**

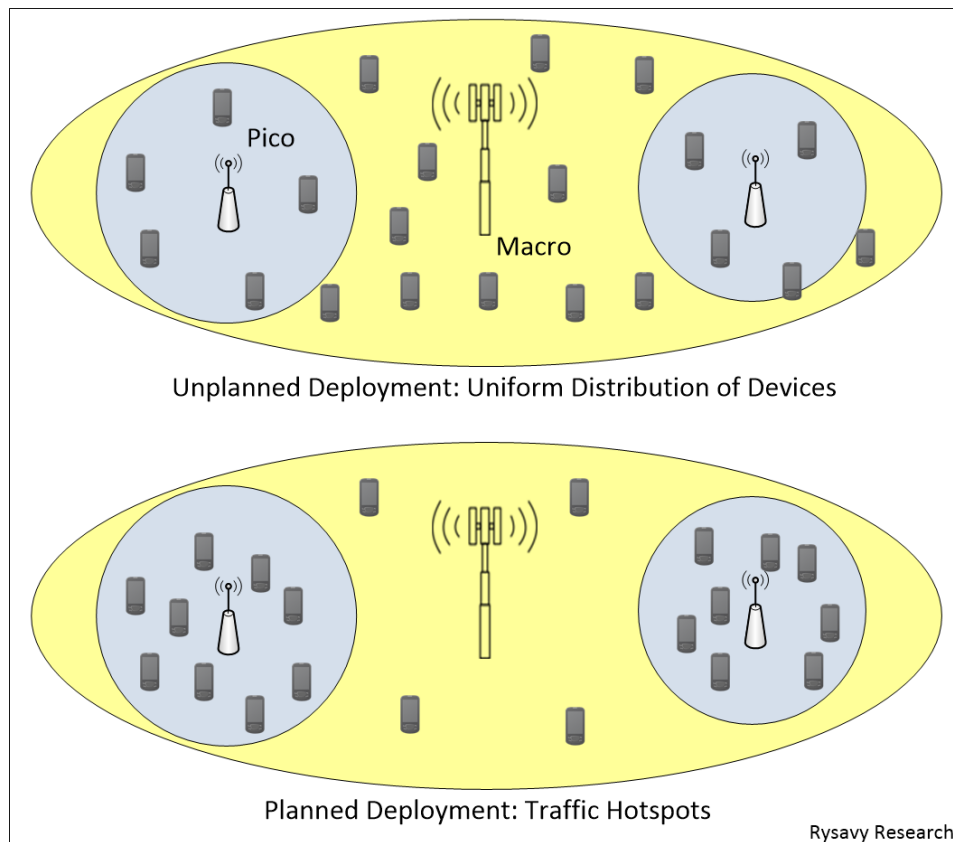

One vendor calculated expected HetNet gains assuming no eICIC, no picocell range extension, and no eICIC. For the case of four picocells without picocell range extension and uniform user distribution, the median-user-throughput gain compared with a macro-only configuration was 85%. For a similar case of four picocells but using a hotspot user distribution, the gain was much higher, 467%.<sup>305</sup> Additional gains will occur with picocell range extension.

Expected picocell gains rise proportionally to the number of picocells, so long as a sufficient number of UEs connect to the picocells.

Release 10 and Release 11 added enhanced support to manage the interference in the HetNet scenario in the time domain with Enhanced Inter-cell Interference Coordination (eICIC) and Further Enhanced Inter-cell Interference Coordination (feICIC), as well as in the frequency domain with carrier-aggregation-based ICIC.

HetNet capability keeps becoming more sophisticated through successive 3GPP releases as summarized in Table 42.

---

<sup>305</sup> 5G Americas member contribution. Further assumes 2X1 W picocell transmit power, cell-edge placement (planned picocell deployment), 67% of all the users within 40m of the pico locations, and 3GPP Technical Report 36.814 adapted to 700 MHz.

**Table 42: 3GPP HetNet Evolution**

3GPP Release	HetNet Feature
8	Initial SON capabilities, most for auto configuration. Initial intercell interference coordination (ICIC) available.
9	More mobility options (for example, handover between HeNBs), operator customer subscriber group (SCG) lists, load-balancing, coverage and capacity improvements.
10	An interface for HeNBs, called "Iurh," that improves coordination and synchronization, LTE time domain eICIC. Carrier-aggregation-based ICIC also defined.
11	Improved eICIC, further mobility enhancements.

### **Enhanced Intercell Interference Coordination**

Significant challenges must be addressed in these heterogeneous networks. One is near-far effects, in which local small-cell signals can easily interfere with macro cells if they are using the same radio carriers.

Interference management is of particular concern in HetNets since, by design, coverage areas of small coverage cells overlap with the macro cell. Beginning with Release 10, eICIC introduces an approach of almost-blank subframes by which subframe transmission can be muted to prevent interference. Figure 134 illustrates eICIC for the macro layer and pico layer coordination. If a UE is on a picocell but in a location where it is sensitive to interference from the macro layer, the macro layer can mute its transmission during specific frames when the pico layer is transmitting.

**Figure 134: Example of Enhanced Intercell Interference Coordination<sup>306</sup>**

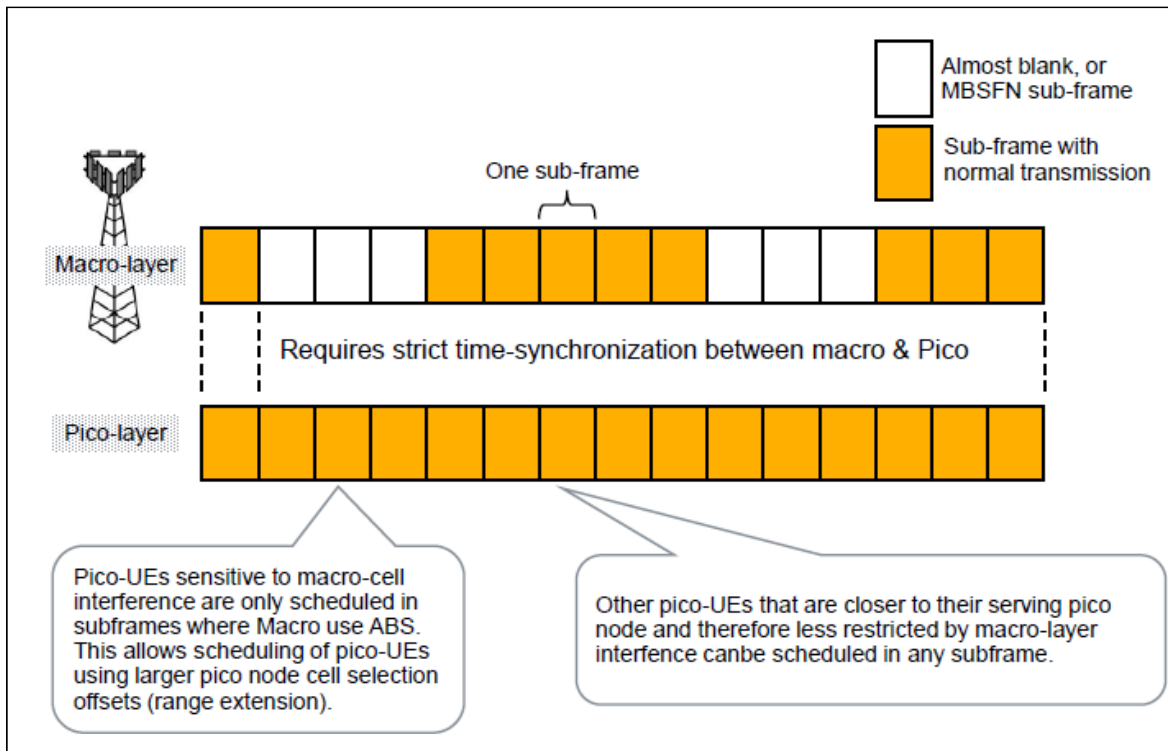

LTE can also combine eICIC with interference-cancellation-based devices to minimize the harmful effects of interference between picocells and macro cells.

Figure 135 shows one 4G America member's analysis of anticipated median throughput gains using picocells and Release 11 Further Enhanced ICIC.

<sup>306</sup> 5G Americas member contribution.

**Figure 135: Median Throughput Gains in Hotspot Scenarios<sup>307</sup>**

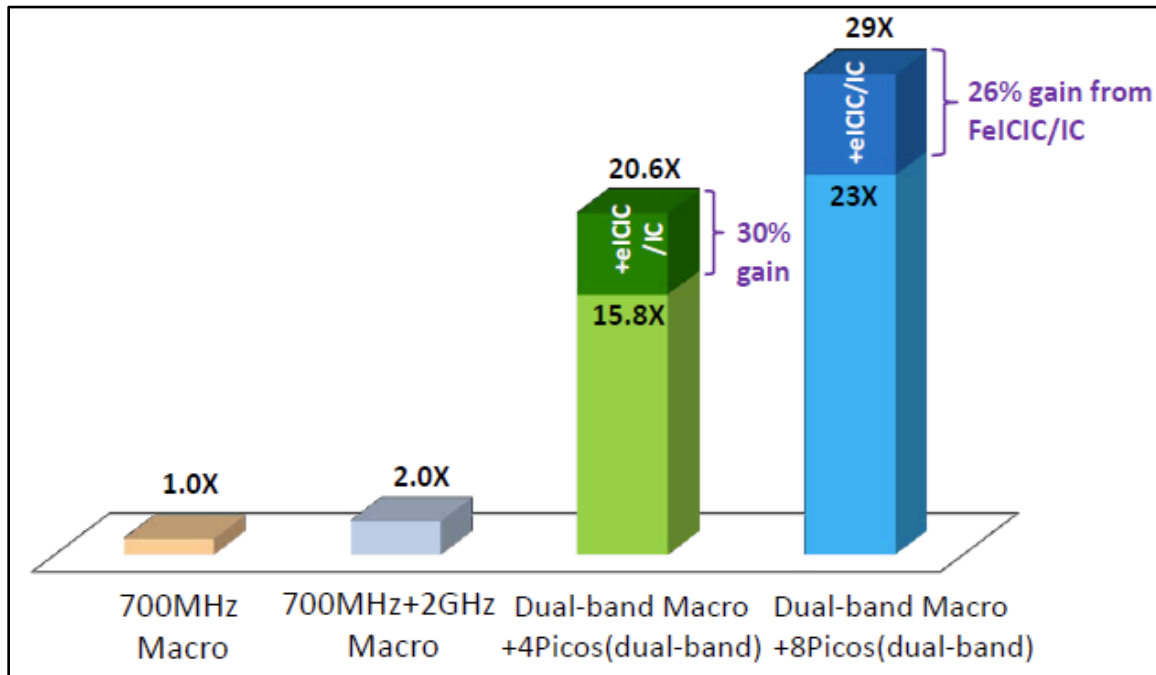

FeICIC is also beneficial in non-hotspot scenarios. In the case of a uniform distribution of picocells, this same 5G Americas member estimates a 130% gain from FeICIC for an eight picocell per macro-cell scenario, increasing capacity from a factor of 3.3 for the picocells alone to a factor of 7.6 with the addition of FeICIC.<sup>308</sup>

Further insight is available from Figure 136, which shows 5 percentile and 50 percentile throughput with and without eICIC under different conditions of range extension and almost blanked subframes.

<sup>307</sup> 5G Americas member contribution. Assumes 3GPP evaluation methodology TR 36.814, carrier-aggregation UEs, macro ISD = 1732m, 700 MHz and 2GHz carrier frequency, full-buffer traffic, FDD 10+10 MHz per carrier, 6-degree antenna downtilt, 4 or 8 Picos and 30 UEs per Macro cell, hotspot distribution with 20 of 30 UEs near picos, PF scheduler, 2x2 MIMO, TU3 channel, NLOS, local partitioning algorithm.

<sup>308</sup> Assumes 3GPP evaluation methodology TR 36.814, macro ISD = 1732m, 700 MHz and 2GHz carrier frequency, full-buffer traffic, 6-degree antenna downtilt, 30 carrier-aggregation UEs per Macro cell, uniform random layout, PF scheduler, FDD, 10+10 MHz per carrier, 2x2 MIMO, TU3 channel, NLOS, local partitioning algorithm. Additional information at [ftp://ftp.3gpp.org/tsg\\_ran/WG1\\_RL1/TSGR1\\_66b/Docs/R1-113383.zip](ftp://ftp.3gpp.org/tsg_ran/WG1_RL1/TSGR1_66b/Docs/R1-113383.zip).



**Figure 136: User Throughput Performance With/Without eICIC for Dynamic Traffic vs. Average Offered Load per Macro Cell Area<sup>309</sup>**

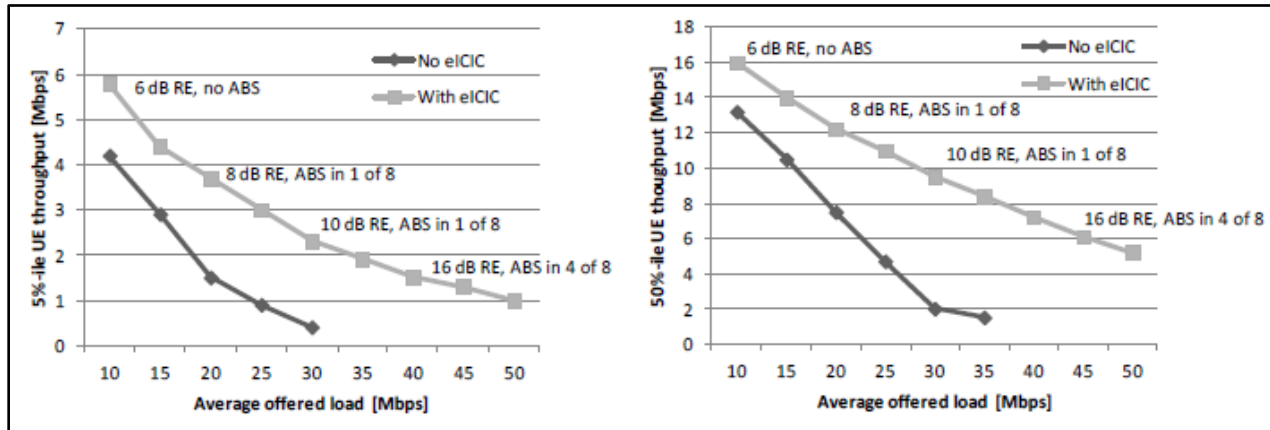

The muting of certain subframes in eICIC is dynamic and depends on identifying, on a per user basis, whether an interfering cell's signal exceeds a threshold relative to the serving cell signal. Coordinating muting among small cells can be complicated because a small cell can simultaneously be an interferer while serving a UE that is a victim of another cell. The network must therefore coordinate muting among multiple small cells.

Figure 137 below at left shows user throughput gains of time domain interference relative to network load. Throughput gains are higher at higher network loads because of more active users and the higher likelihood of interference between the small cells.

Figure 137 below at right shows the maximum muting ratio, which increases with higher network load.

<sup>309</sup> 5G Americas member contribution. Assumes 3GPP evaluation methodology TR 36.814, 500-meter ISD, 4 picos per macro-cell area, Poisson call arrival, finite payload for each call, and termination of call upon successful delivery.

**Figure 137: Throughput Gain of Time-Domain Interference Coordination<sup>310</sup>**

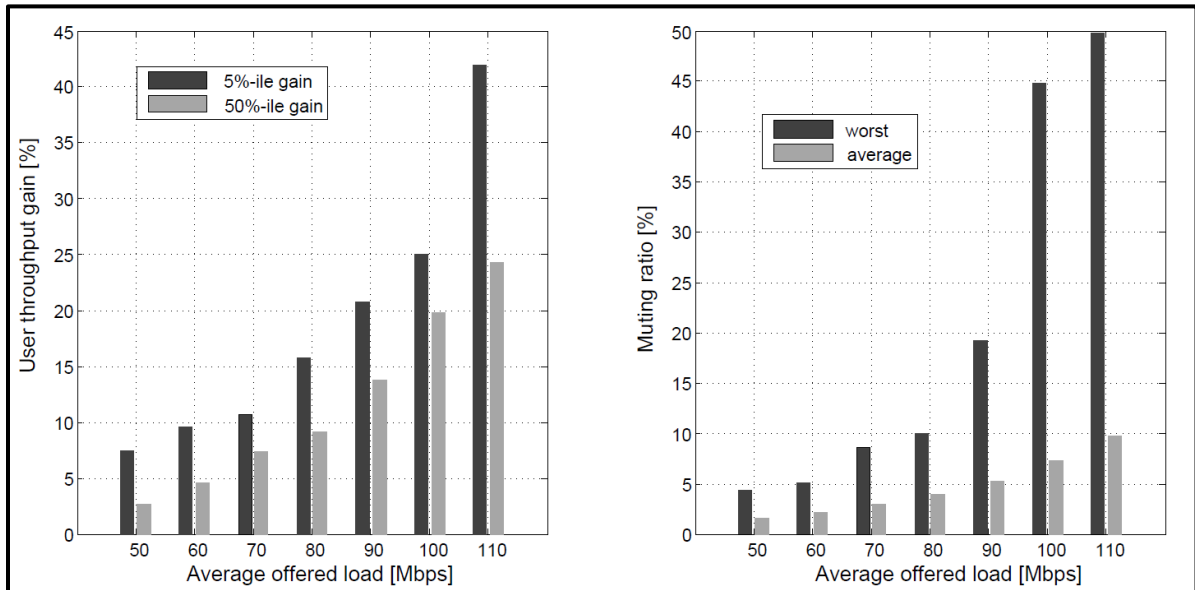

Another approach for addressing inter-layer interference cancellation in HetNets can come from carrier aggregation with no further additions or requirements and realizable with Release 10 LTE networks. Consider the scenario in Figure 138, in which both the macro eNB and the pico eNB are allocated two component carriers (namely CC1 and CC2). The idea is to create a “protected” component carrier for downlink control signals and critical information (Physical Downlink Control Channel, system information, and other control channels) while data can be conveniently scheduled on both component carriers through cross-carrier scheduling.

**Figure 138: Carrier-Aggregation Based ICIC<sup>311</sup>**

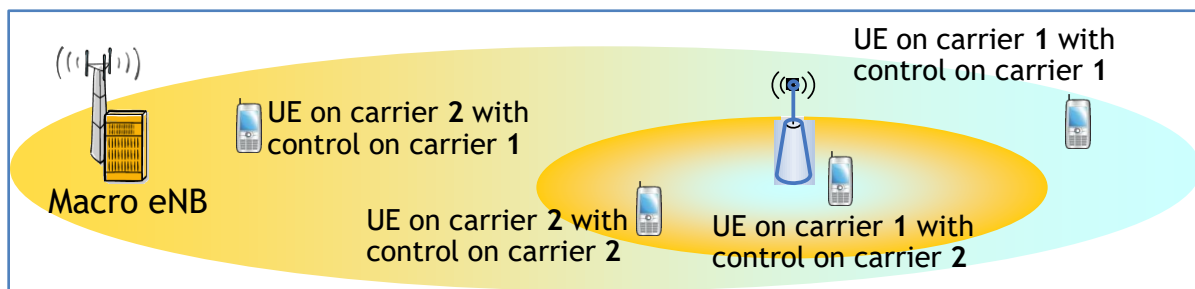

CC1 is the primary component carrier for the macro cell, while CC2 is the primary for the picocell; hence the protected carriers are CC1 for the macro cell and CC2 for the picocell. The macro cell allocates a lower transmission power for its secondary CC in order to reduce interference to the picocell’s primary component carrier. The network can schedule data on both the primary and secondary component carriers. In the figure, users in the cell range expansion (CRE) zone can receive data via cross-carrier scheduling from the

<sup>310</sup> 5G Americas member contribution. Simulations based on 12 densely deployed small cells at 3.5 GHz and 3GPP Release 12 simulation assumptions in TR 36.842.

<sup>311</sup> 5G Americas member contribution.

secondary CC at subcarrier frequencies on which interference from the other cell can be reduced if the cells exchange appropriate signaling over what is called an “X2 interface.” Users operating close to the eNodeBs can receive data from both component carriers as their interference levels will hopefully be lower. Therefore, a CA-capable receiver will enjoy the enhanced throughput capabilities of carrier aggregation, while simultaneously receiving extra protection for control and data channels at locations with potentially high inter-layer interference.

Thus, carrier aggregation can be a useful tool for deployment of heterogeneous networks without causing a loss of bandwidth. These solutions, however, do not scale well (in Release 10 systems) to small system bandwidths (say, 3+3 MHz or 1.4+1.4 MHz radio carriers) because control channels occupy a high percentage of total traffic. Additionally, interference between the cell reference signals (CRS) would also be significant.

### Dual Connectivity

A major enhancement in Release 12 is a UE being served at the same time by both a macro cell and a small cell operating at different carrier frequencies, a capability called dual connectivity and illustrated in Figure 139. Data first reaches the macro eNodeB and is split, with part of it transmitted from the macro and the balance sent via an X2 interface to the small cell for transmission to the UE.

**Figure 139: Dual Connectivity**<sup>312</sup>

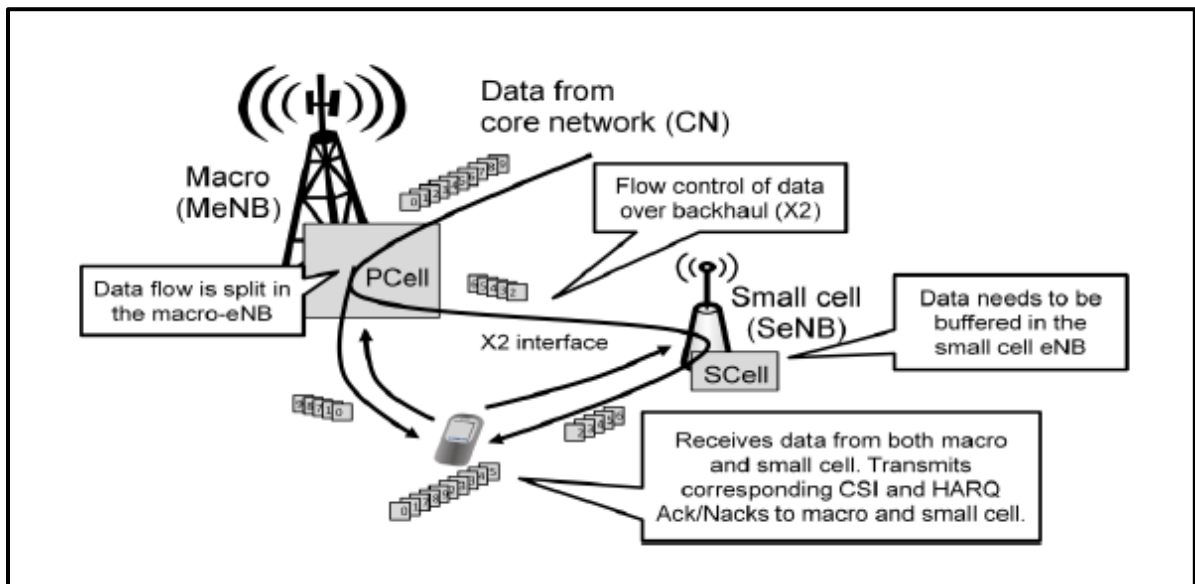
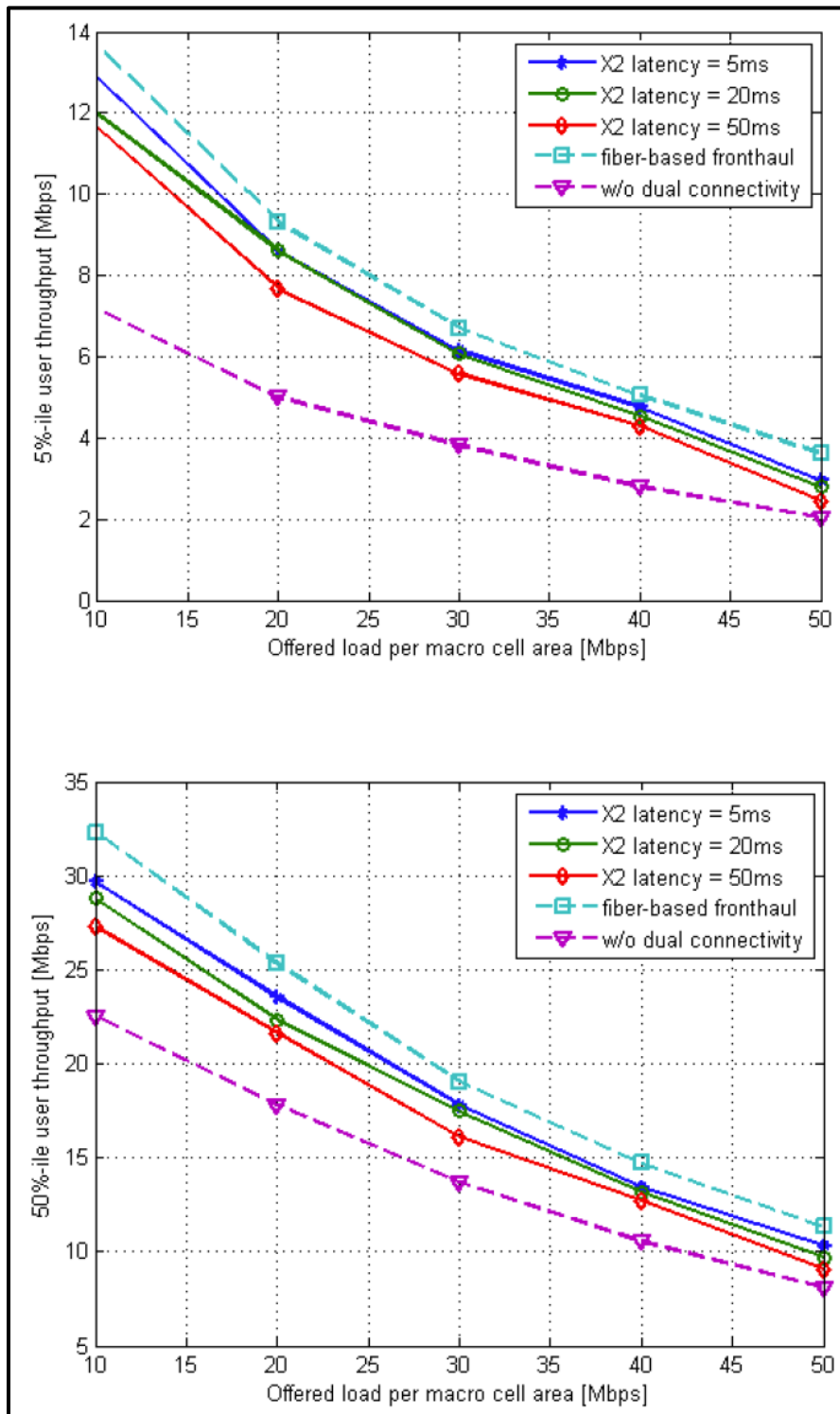

Figure 140 shows throughput gains of dual connectivity at 5 percentile and 50 percentile (median) levels relative to the load on the network and different degrees of latency in the X2 interface. Benefits are higher with lower network load and with lower X2 latency.

<sup>312</sup> Source: 5G Americas member contribution.

**Figure 140: Dual Connectivity User Throughput<sup>313</sup>**



<sup>313</sup> 5G Americas member contribution.

## Internet of Things and Machine to Machine

Anticipating huge growth in machine-to-machine communications, Release 11 added a Machine Type Communications (MTC) Interworking Function and Service Capability Server. Release 12 defined a category 0 device designed to deliver low cost through a single antenna design and other simplifications.<sup>314</sup> Release 13 went even further, with a category M-1 architecture that further reduces cost, improves range, and extends battery life. Category 13 also added Narrowband-IoT capability with Category NB-1 and an IoT solution for GSM, called "EC-GSM-IoT," that extends coverage by 20 dB. Category M-1 and NB-IoT devices could achieve battery life as high as 10 years.

Figure 141 depicts the methods used to reduce cost in a Category M device compared with a Category 4 device.

**Figure 141: Means of Achieving Lower Cost in IoT Devices<sup>315</sup>**

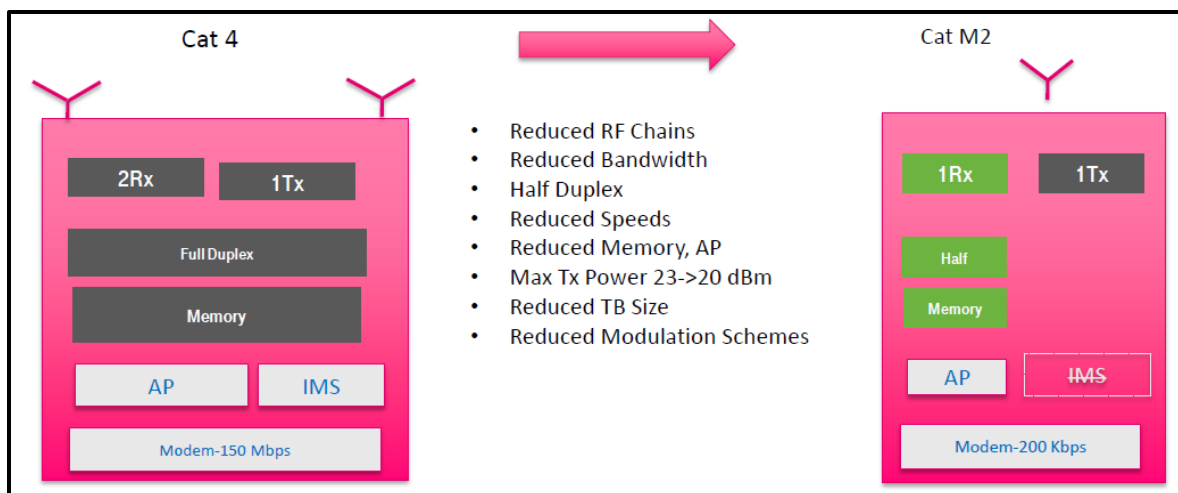

Table 43 summarizes the features of different LTE IoT devices based on 3GPP Release.

**Table 43: Summary of IoT Features in LTE Devices**

Device Category	Category 3	Category 1	Category 0	Category M-1	Category NB-1	EC-GSM-IoT
<b>3GPP Release</b>	10	11	12	13	13	13
<b>Max. Data Rate Downlink</b>	100 Mbps	10 Mbps	1 Mbps	1 Mbps	200 Kbps	74 Kbps
<b>Max. Data Rate Uplink</b>	50 Mbps	5 Mbps	1 Mbps	1 Mbps	200 Kbps	74 Kbps

<sup>314</sup> 3GPP, Access System for Ultra Low Complexity and Low Throughput Internet of Things based on Cellular, GP-140301, May 2014.

<sup>315</sup> 5G Americas member contribution.

Device Category	Category 3	Category 1	Category 0	Category M-1	Category NB-1	EC-GSM-IoT
<b>Max. Bandwidth</b>	20 MHz	20 MHz	20 MHz	1.08 MHz	0.18 MHz	0.2 MHz
<b>Duplex</b>	Full	Full	Optional half-duplex	Optional half-duplex	Half	Half
<b>Max. Receive Antennas</b>	Two	Two	One	One	One	One
<b>Power</b>		Power Save Mode <sup>316</sup>	Power Save Mode	Power Save Mode		
<b>Sleep</b>				Longer sleep cycles using Idle Discontinuous Reception (DRX)		
<b>Coverage</b>				Extended through redundant transmissions and Single Frequency Multicast		

## ***Cloud Radio-Access Network (RAN) and Network Virtualization for LTE***

Still in the early stages of development, cloud RAN (C-RAN) is a distributed architecture in which multiple remote radio heads connect to a “cloud” that consists of a farm of baseband processing nodes. This approach can improve centralized processing, as is needed for CoMP, centralized scheduling, and Multiflow, without the need to exchange information among many access nodes. The performance of both LTE and HSPA technologies could be enhanced by the application of cloud RAN architectures. The term “fronthauling” has been used to describe the transport of “raw” radio signals to central processing locations, such as between the Physical Network Function (PNF) and a Virtual Network Function (VNF). The fronthaul is the connection layer between a baseband unit

---

<sup>316</sup> Power Save Mode specified in Release 12, but applicable to Category 1 device configured as Release 12.

(BBU) pool and a set of remote radio units (RRU), providing high-bandwidth links to handle the requirements of multiple RRUs.

This architecture, shown in Figure 142, comes at the cost of requiring high-speed, low-latency backhaul links between these radio heads and the central controller. One vendor states that carrying 10+10 MHz of LTE with 2X2 MIMO requires 2.5 Gbps of bandwidth and imposes less than 0.1 msec of delay.<sup>317</sup> A standard called “Common Public Radio Interface” (CPRI) addresses generic formats and protocols for such a high-speed link. ETSI has also developed the Open Radio Equipment Interface (ORI). The feasibility of cloud RAN depends to a large extent on the cost and availability of fiber links between the remote radio heads and the centralized baseband processing location.

Unlike virtualizing the EPC, in which the entirety of the function can be virtualized, cloud RAN needs a PNF that terminates the RF interface. Cloud RAN therefore requires a split to be defined within the RAN. As a consequence, initial deployments of cloud RAN have looked to ruse the CPRI interface between the RRH and the baseband unit.

**Figure 142: Potential Cloud RAN Approach**

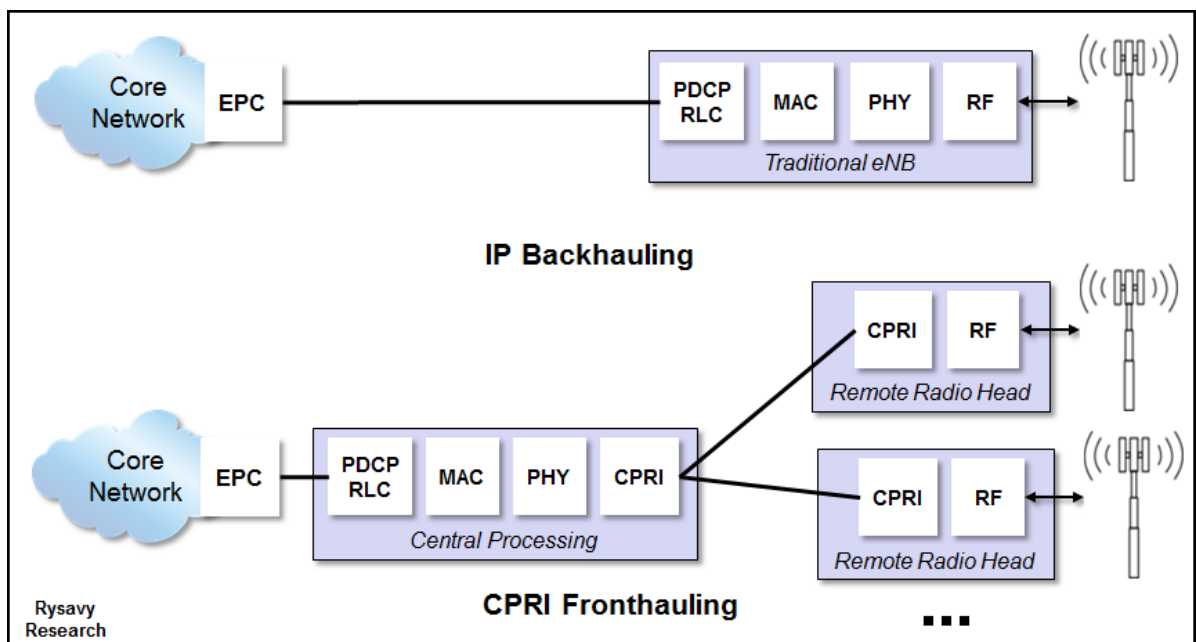

The next evolutionary step after centralizing baseband processing is to virtualize the processing by implementing the functions in software on commodity computing platforms, thus abstracting the functions from any specific hardware implementation.

C-RANs can vary by the extent of coverage, ranging from being highly localized and operating across a small number of sites to metropolitan-wide solutions. Other variables include existing deployments versus greenfield situations, new LTE and 5G technologies versus integrating legacy 2G and 3G technologies, and integrating Wi-Fi. Greater scope

<sup>317</sup> Dudu Bercovich, Ran Avital, “Holistic HetNet Hauling (3H),” Ceragon, Feb. 2013. [http://www.ceragon.com/images/Reasource\\_Center/White\\_Papers/Ceragon\\_Holistic\\_Hetnet\\_Hauling\\_White\\_Paper.pdf](http://www.ceragon.com/images/Reasource_Center/White_Papers/Ceragon_Holistic_Hetnet_Hauling_White_Paper.pdf).

increases complexity but yields benefits including better load-balancing and greater flexibility in spectrum re-farming.

Another design choice, as detailed in Table 44, is whether to centralize Layer 1 and Layer 2 functions (an RF-PHY split), or whether to keep Layer 1 at the base stations and centralize only Layer 2 (a PHY-MAC split).

**Table 44: Partially Centralized Versus Fully Centralized C-RAN**

	Fully Centralized	Partially Centralized
Transport Requirements	Multi-Gbps, usually using fiber	20 to 50 times less
Fronthaul Latency Requirement	Less than 100 microseconds	Greater than 5 milliseconds
Applications	Supports eICIC and CoMP	Supports centralized scheduling
Complexity	High	Lower
Benefit	Capacity gain	Lower capacity gain

In the past, RAN and core networks have been distinct entities, but over the next decade, the two may merge with more centralized, virtualized, and cloud-driven approaches.

Another form of virtualization is software-defined networking, an emerging trend in both wired and wireless networks. For cellular, SDN promises to reduce OPEX costs, simplify the introduction of new services, and improve scalability; all major infrastructure vendors are involved. The Open Networking Foundation explains that an SDN decouples the control and data planes, centralizing network state and intelligence, while abstracting the underlying network infrastructure from applications.<sup>318</sup> Virtualization of network functions will be a complex, multi-year undertaking and will occur in stages, as shown in Figure 143.

---

<sup>318</sup> Open Networking Foundation, "Software-Defined Networking: The New Norm for Networks," <http://www.opennetworking.org/sdn-resources/sdn-library/whitepapers>, accessed Jun. 20, 2014.



**Figure 143: Software-Defined Networking and Cloud Architectures<sup>319</sup>**

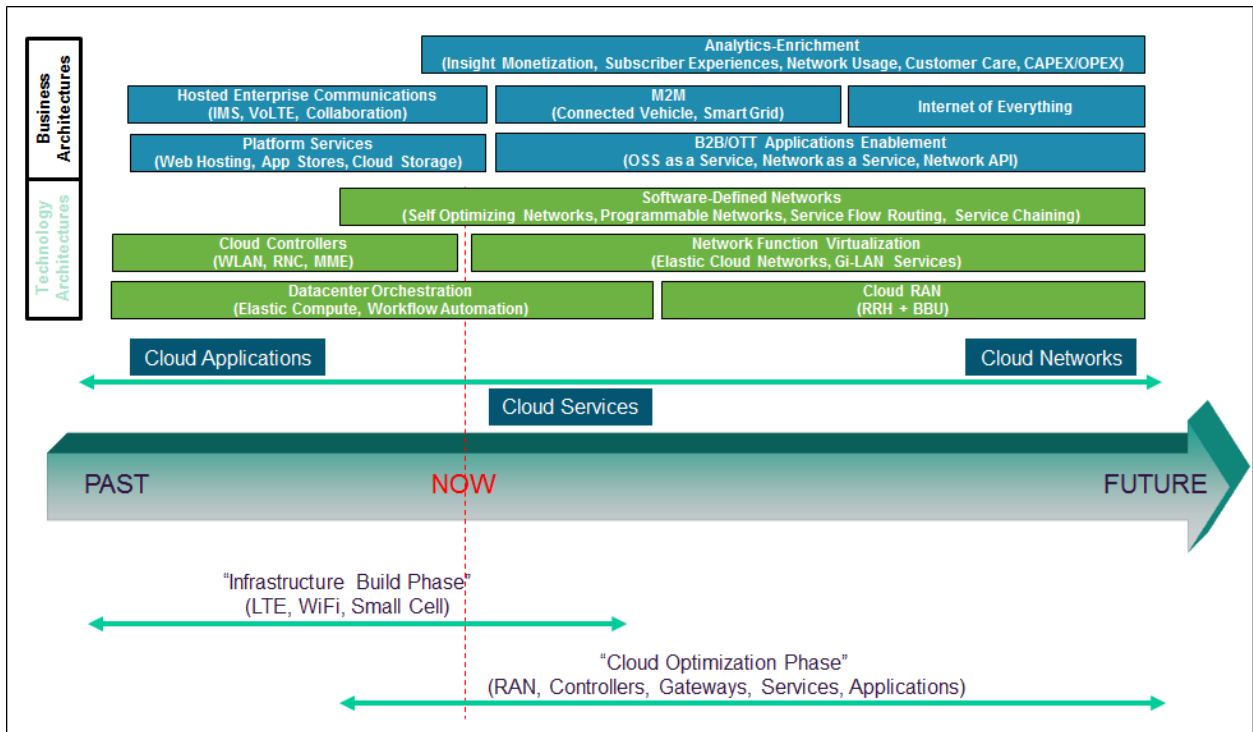

Although some operators implemented virtualization for their LTE networks, 5G networks facilitate virtualization and will drive widespread adoption of virtualization and cloud architectures. Refer to the section, "Virtualization and Cloud Native" in the main body of this paper for further details.

### ***Other Unlicensed Spectrum Integration***

See the earlier section in this report on unlicensed spectrum integration, which includes a discussion of LTE-U, LTE-LAA, MulteFire, LWA, LWIP, and RCLWI. This section covers integration approaches other than these.

3GPP has evolved its thinking on how best to integrate Wi-Fi with 3GPP networks. At the same time, the Wi-Fi Alliance and other groups have also addressed hotspot roaming, namely the ability to enable an account with one public Wi-Fi network provider to use the services of another provider that has a roaming arrangement with the first provider.

The multiple attempts to make Wi-Fi networks universally available have made for a confusing landscape of integration methods, which this section attempts to clarify. Most integration today is fairly loose, meaning that either a device communicates data via the cellular connection or via Wi-Fi. If via Wi-Fi, the connection is directly to the internet and bypasses the operator core network. In addition, any automatic handover to hotspots occurs only between the operator cellular network and operator-controlled hotspots. The goals moving forward are to:

<sup>319</sup> 5G Americas member contribution.

- ❑ Support roaming relationships so that users can automatically access Wi-Fi hotspots operated by other entities.
- ❑ Enable automatic connections so that users do not have to enter usernames and passwords. In most cases, this will mean authentication based on SIM credentials.
- ❑ Provide secure communications on the radio link as provided by the IEEE 802.11i standard.
- ❑ Allow policy-based mechanisms that define the rules by which devices connect to various Wi-Fi networks.
- ❑ Enable simultaneous connections to both cellular and Wi-Fi, with control over which applications use which connections.
- ❑ Support different types of Wi-Fi deployments, including third-party access points and carrier access points.

### **Release 6 I-WLAN**

3GPP Release 6 was the first release to offer the option of integrating Wi-Fi in a feature called “Interworking WLAN” (I-WLAN), using a separate IP address for each network type.

### **Release 8 Dual Stack Mobile IPv6 and Proxy Mobile IPv6**

3GPP Release 8 specified Wi-Fi integration with the EPC using two different approaches: host-based mobility with Dual Stack Mobile IPv6 (DSMIPv6) in the client, and network-based mobility with Proxy Mobile IPv6 (PMIPv6) using an intermediary node called an “Enhanced Packet Data Gateway” (ePDG).<sup>320</sup> This method is intended for untrusted (non-carrier-controlled) Wi-Fi networks.

### **Release 11 S2a-based Mobility over GTP**

Release 11, however, implements a new and advantageous approach as shown in Figure 144, one that eliminates the ePDG. Called “S2a-based Mobility over GTP” (SaMOG), a trusted WLAN Access Gateway connects to multiple 3GPP-compliant access points. Traffic can route directly to the internet or traverse the packet core. This method is intended for trusted (carrier-controlled) Wi-Fi networks.

---

<sup>320</sup> 3GPP, System Architecture Evolution (SAE); Security aspects of non-3GPP accesses. TS 33.402.

**Figure 144: Release 11 SaMOG-based Wi-Fi Integration**

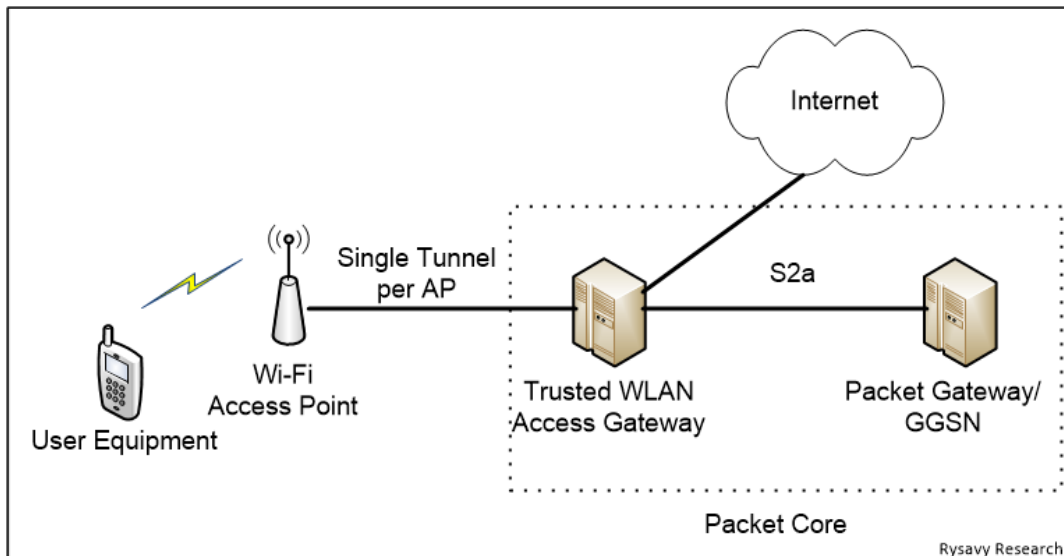

Release 12 improves SaMOG capabilities in Enhanced SaMOG (eSaMOG), in which UEs can:

- ❑ Request the connectivity type.
- ❑ Indicate the Access Point Name (APN) to establish PDN connectivity.
- ❑ Request to hand over an existing PDN connection.
- ❑ Establish multiple PDN connections in parallel over the WLAN.
- ❑ Establish a non-seamless WLAN offload connection in parallel to a Packet Data Network connection over WLAN.

## Multipath TCP

A new method for potentially integrating Wi-Fi and 3GPP networks is based on work by the Internet Engineering Taskforce (IETF). Called "Multipath TCP," the approach allows a TCP connection to occur simultaneously over two different paths. The advantages of this approach include higher speeds by aggregating links and not requiring any special provisions for link-layer handovers.

The IETF has published an experimental specification, *Request for Comments 6824: CP Extensions for Multipath Operation with Multiple Addresses*, which explains this approach. The IETF is also specifying Multipath QUIC.

## ANDSF

Another relevant specification is 3GPP Access Network Discovery and Selection Function (ANDSF), which provides mechanisms by which mobile devices can know where, when,

and how to connect to non-3GPP access networks, such as Wi-Fi.<sup>321</sup> ANDSF operates independently of SaMOG or other ways that Wi-Fi networks might be connected.

ANDSF functionality increases with successive 3GPP versions, as summarized in Table 45.

**Table 45: ANDSF Policy Management Objects and 3GPP Releases<sup>322</sup>**

ANDSF Policy Type	Policy Rule & Management Object	Release 8, 9	Release 10, 11	Release 12
Inter-System Mobility Policy (ISMP)	Policy, Rule priority, Prioritized Access, Validity Area (3G,4G, Wi-Fi, Geo), PLMN, Time-of-Day	X	X	X
Discovery Info	Access Network Type, Access Network Area (3G, 4G, Wi-Fi, Geo), Access Network Reference	X	X	X
UE Location	3GPP, 3GPP2, WiMAX, Wi-Fi network ID, Geo Location, PLMN	X	X	X
Inter-System Routing Policy (ISRP)	Flow Based routing, Service Based routing, Non-Seamless Offload, Roaming, PLMN, Routing Criteria, Time-of-Day, Routing rule		X	X
UE Profile	Device app/OS capability		X	X
Inter-APN Routing Policy (IARP)	Inter-APN routing over IP interface (in progress)			X
WLAN Selection Policy	Operator defined WLAN selection policy			X
Rule Selection Information	VPLMN with preferred WLAN roaming			X
Home Operator Preference	Home SP preference for S2a PDN session			X

### Bidirectional Offloading Challenges

Eventually, operators will be able to closely manage user mobile broadband and Wi-Fi connections, dynamically selecting a particular network for a user based on real-time changes in loads and application requirements. Work is occurring in Release 12 to define parameters that would control switching from LTE to Wi-Fi or from Wi-Fi to LTE.<sup>323</sup>

Bidirectional offloading, however, creates various challenges, as shown in Figure 145 and discussed below.

<sup>321</sup> 3GPP, *Architecture enhancements for non-3GPP accesses*, Technical Specification 23.402.

<sup>322</sup> Courtesy Smith Micro Software, 2014. <http://www.smithmicro.com>.

<sup>323</sup> 3GPP, *Study on Wireless Local Area Network (WLAN) - 3GPP radio interworking (Release 12)*, TR 37.834.

**Figure 145: Bidirectional Offloading Challenges**

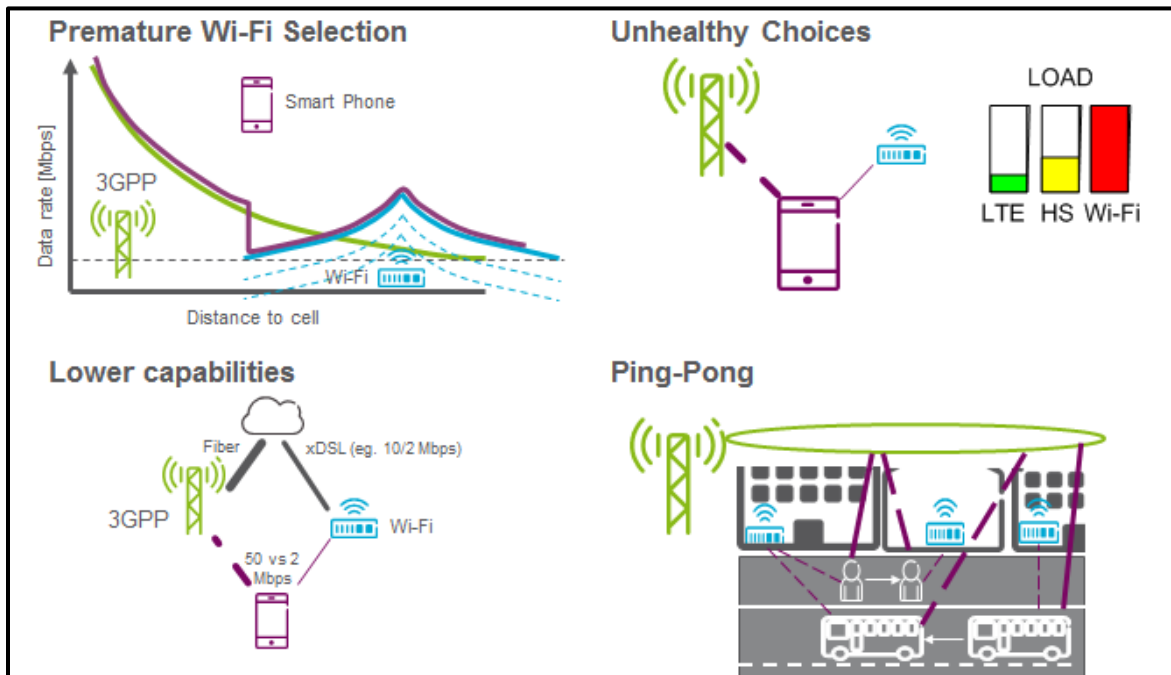

- ❑ **Premature Wi-Fi Selection.** As Wi-Fi-capable devices move into Wi-Fi coverage, they can prematurely reselect to Wi-Fi without comparative evaluation of existing cellular and incoming Wi-Fi capabilities, possibly resulting in the degradation of the end user experience. Real-time throughput-based traffic steering can mitigate this effect.
- ❑ **Unhealthy choices.** In a mixed network of LTE, HSPA, and Wi-Fi, reselection can occur due to a strong Wi-Fi network signal even though the network is under heavy load. The resulting “unhealthy” choice degrades the end user experience because the performance on the cell edge of a lightly loaded cellular network may be superior to that of the heavily loaded Wi-Fi network. Real-time load-based traffic steering can be beneficial in this scenario.
- ❑ **Lower capabilities.** In some cases, selection to a Wi-Fi network may result in reduced performance even if it offers a strong signal because of other factors, such as lower-bandwidth backhaul. Evaluation of criteria beyond wireless capabilities prior to access selection can improve this circumstance.
- ❑ **Ping-Pong.** Ping-ponging between Wi-Fi and cellular, especially if both offer similar signal strengths, can also degrade the user experience. Hysteresis approaches, similar to those used in cellular inter-radio transfer, can better manage transfer between Wi-Fi and cellular accesses.

3GPP RAN2 is discussing real-time or near-real-time methods to address the challenges discussed above.

### **Other Integration Technologies (SIPTO, LIPA, IFOM, MAPCON)**

Release 10 defines additional options for Wi-Fi integration, including Selected IP Traffic Offload (SIPTO), Local IP Access (LIPA), Multi-Access PDN Connectivity (MAPCON), and IP Flow and Seamless Offload (IFOM).

SIPTO is mostly a mechanism to offload traffic that does not need to flow through the core, such as internet-destined traffic. SIPTO can operate on a home femtocell, or it can operate in the macro network.

Local IP Access (LIPA) provides access to local networks, useful with femtocells that normally route all traffic back to the operator network. With LIPA, the UE in a home environment can access local printers, scanners, file servers, media servers, and other resources.

IFOM, as shown in Figure 146, enables simultaneous cellular and Wi-Fi connections, with different traffic flowing over the different connections. A Netflix movie could stream over Wi-Fi, while a VoIP call might flow over the cellular-data connection. IFOM requires the UE to implement Dual Stack Mobile IPv6 (DSMIPv6).

**Figure 146: 3GPP IP Flow and Seamless Mobility**

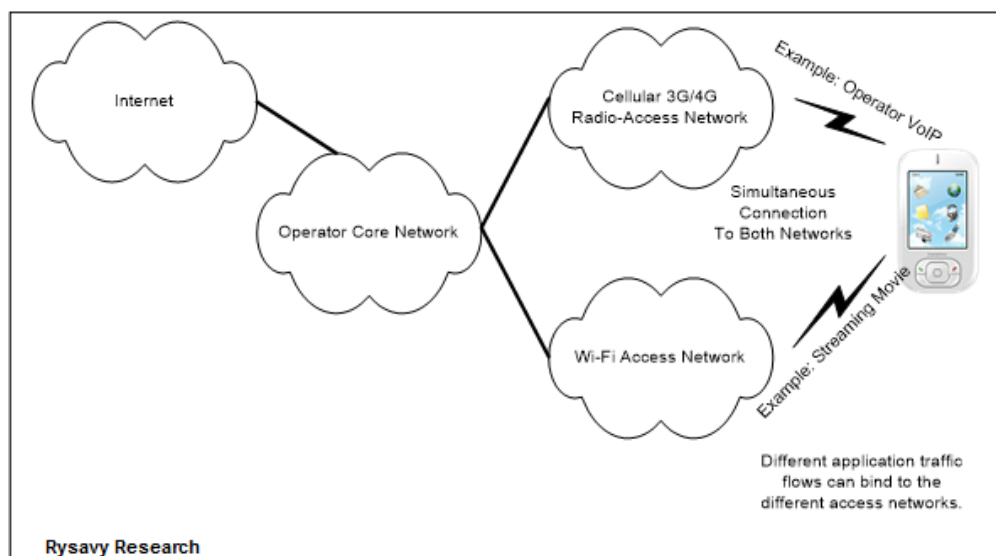

Similar to IFOM, Release 10 feature MAPCON allows multiple simultaneous PDN connections (each with a separate APN), such as Wi-Fi and 3GPP radio access. The UE uses separate IP addresses for each connection but does not need Dual Stack Mobile IPv6 (DSMIPv6).

## Hotspot 2.0

Developed by the Wi-Fi Alliance, Hotspot 2.0 specifications, also called "Next Generation Hotspot," facilitate Wi-Fi roaming. Using the IEEE 802.11u standard that allows devices to determine what services are available from an access point, Hotspot 2.0 simplifies the process by which users connect to hotspots, automatically identifying roaming partnerships and simplifying authentication and connections, as shown in Figure 147.<sup>324</sup> It also provides for encrypted communications over the radio link.<sup>325</sup>

<sup>324</sup> For example, user devices can be authenticated based on their SIM credentials. Or, users can register or click through an agreement and then not need to redo that with future associations.

<sup>325</sup> The IEEE 802.11i standard has provided encryption for 802.11 communications for many years; however, most hotspots have not implemented this encryption, whereas Hotspot 2.0 does.

**Figure 147: Roaming Using Hotspot 2.0**

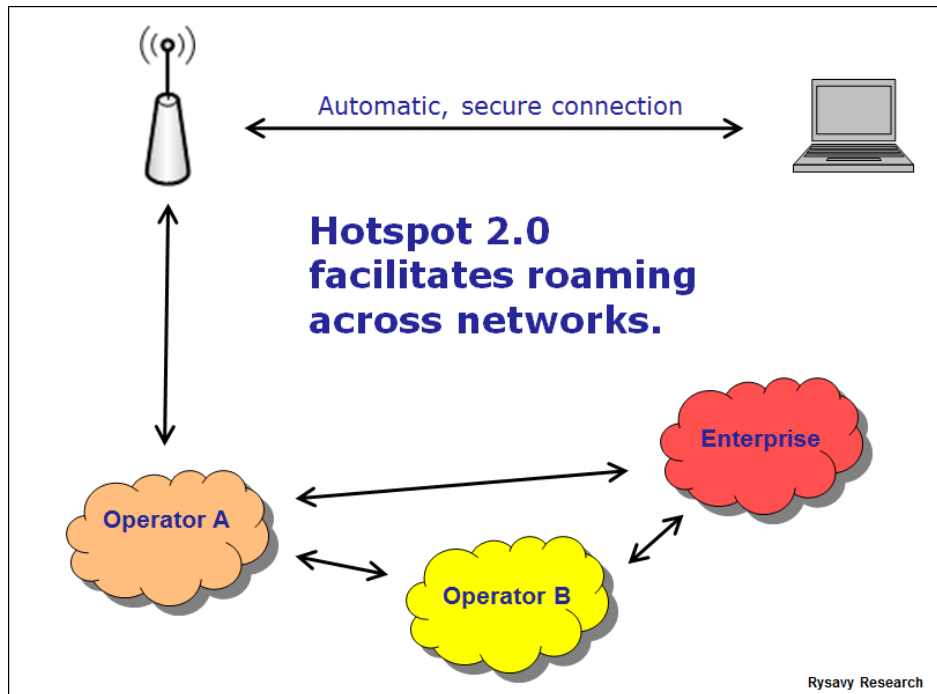

Using IEEE 802.11u, devices can determine what roaming relationships an access point supports and can then securely connect to the Wi-Fi network using one of these roaming arrangements, as shown in Figure 148. Hotspot 2.0 authentication is based on the Extended Authentication Protocol (EAP) using SIM credentials. There are plans to enhance the Hotspot 2.0 protocols in Phase 2, which will define online signup to enable non-SIM-based devices to easily and securely register for services. The Wi-Fi Alliance began a Hotspot 2.0 certification process for devices and access points in June 2012 and uses the designation "Wi-Fi Certified Passpoint" for compliant devices.

**Figure 148: Hotspot 2.0 Connection Procedure**

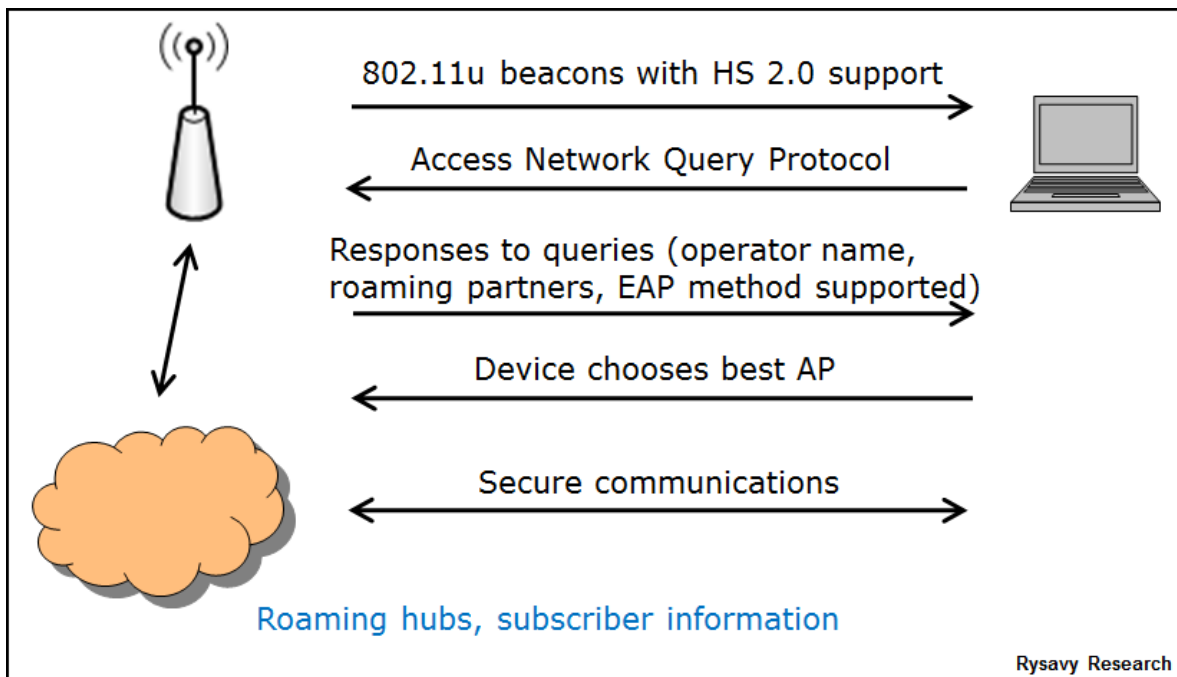

Release 2 of Passpoint, available in 2014, added immediate account provisioning, which facilitates a user establishing an account at the point of access. The new version also provides for policies to be downloaded from the network operator; these policies control network selection priorities when multiple networks are available.

## ***Self-Organizing Networks (SON)***

As the number of base stations increase through denser deployments and through deployment of femtocells and picocells, manual configuration and maintenance of this infrastructure becomes impractical. With SON, base stations organize and configure themselves by communicating with one another and with the core network. SONs can also self-heal in failure situations.

3GPP began standardization of self-optimization and self-organization in Releases 8 and 9, a key goal being support of multi-vendor environments. Successive releases have augmented SON capabilities.

Features being defined in SON include:

- ❑ Automatic inventory
- ❑ Automatic software download
- ❑ Automatic neighbor relation
- ❑ Automatic physical Cell ID assignment
- ❑ Mobility robustness/handover optimization
- ❑ Random access channel optimization
- ❑ Load-balancing optimization



- ❑ Inter-cell interference coordination (ICIC) management
- ❑ Enhanced inter-cell interference coordination (eICIC) management
- ❑ Coverage and capacity optimization
- ❑ Cell outage detection and compensation
- ❑ Self-healing functions
- ❑ Minimization of drive testing
- ❑ Energy savings
- ❑ Coordination among various SON functions

3GPP categorizes SON as centralized, distributed, or hybrid, which is a combination of centralized and distributed approaches.

In a centralized architecture, SON algorithms operate on a central network management system or central SON server. In contrast, in a distributed approach, the SON algorithms operate at the eNBs, which make autonomous decisions based on local measurements as well as from other nearby eNBs received via an X2 interface that interconnects eNBs.

The distributed architecture permits faster and easier deployment but is not necessarily as efficient or as consistent in operation, especially in multi-vendor infrastructure deployments.

In a hybrid approach, shown in Figure 149, SON algorithms operate both at the eNB and at a central SON server, with the server supplying values of initial parameters, for example. The eNBs may then update and refine those parameters in response to local measurements.

The hybrid approach resolves deployment scenarios that cannot be resolved by dSON, for example, cases such as:

- ❑ No X2 interface between the eNBs.
- ❑ Multi-vendor deployment with different dSON algorithms.
- ❑ Multi-technology load balancing and user steering.

**Figure 149: Hybrid SON Architecture<sup>326</sup>**

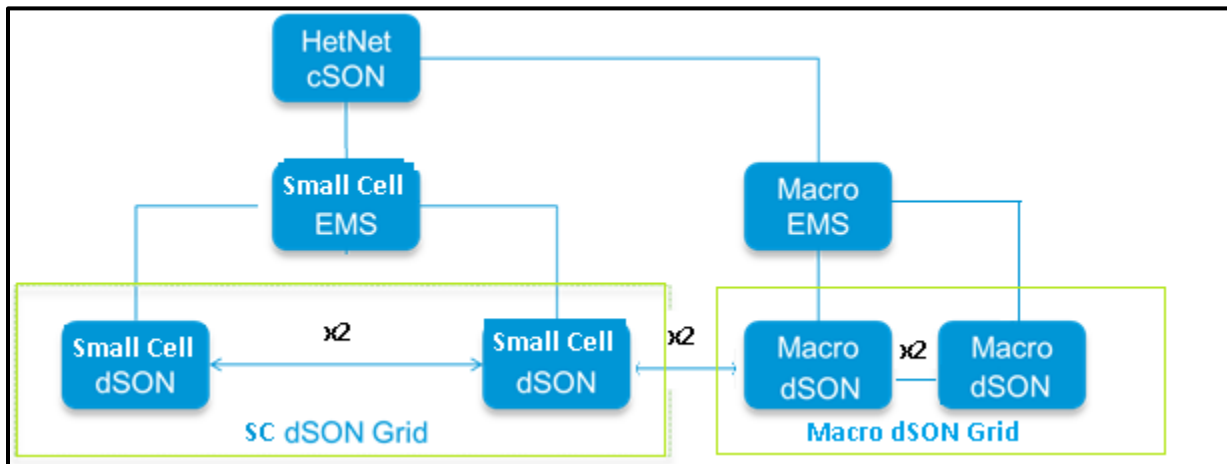

With increasing numbers of macro cells and small cells, interference opportunities increase as well. Optimizing power settings through intelligent power management algorithms is crucial for maximum efficiency with the least amount of interference, including pilot pollution. Pilot pollution can result in low data rates and ping-pong handovers due to channel fading. A hybrid SON approach is well suited for optimized power management.

## ***IP Multimedia Subsystem (IMS)***

IP Multimedia Subsystem (IMS) is a service platform for IP multimedia applications: video sharing, PoC, VoIP, streaming video, interactive gaming, and others. IMS by itself does not provide all these applications. Rather, it provides a framework of application servers, subscriber databases, and gateways to make them possible. The exact services will depend on cellular operators and the application developers that make these applications available to operators. The primary application today, however, is VoLTE. 5G networks will also use IMS, making 5G simply another access network for IMS.<sup>327</sup>

The core networking protocol used within IMS is Session Initiation Protocol (SIP), which includes the companion Session Description Protocol (SDP) used to convey configuration information such as supported voice codecs. Other protocols include Real Time Transport Protocol (RTP) and Real Time Streaming Protocol (RTSP) for transporting actual sessions. The QoS mechanisms in UMTS will be an important component of some IMS applications.

Although originally specified by 3GPP, numerous other organizations around the world are supporting IMS. These include the IETF, which specifies key protocols such as SIP, and the Open Mobile Alliance, which specifies end-to-end, service-layer applications. Other organizations supporting IMS include the GSMA, ETSI, CableLabs, 3GPP2, The Parlay Group, the ITU, ANSI, the Telecoms and Internet Converged Services and Protocols for Advanced Networks (TISPAN), and the Java Community Process (JCP).

<sup>326</sup> 5G Americas member contribution.

<sup>327</sup> For further details, see 3GPP, *System Architecture for the 5G System; Stage 2, (Release 15)*, TS 23.501 V15.1.0 (2018-03), section 4.4.3. See also 3GPP, *IP Multimedia Subsystem (IMS); Stage 2, (Release 15)*, TS 23.228 V15.2.0 (2018-03).

IMS is relatively independent of the radio-access network and can, and likely will, be used by other radio-access networks or wireline networks. Other applications include picture and video sharing that occur in parallel with voice communications. Operators looking to roll out VoIP over networks will use IMS. For example, VoLTE depends on IMS infrastructure. 3GPP initially introduced IMS in Release 5 and has enhanced it in each subsequent specification release.

As shown in Figure 150, IMS operates just outside the packet core.

**Figure 150: IP Multimedia Subsystem**

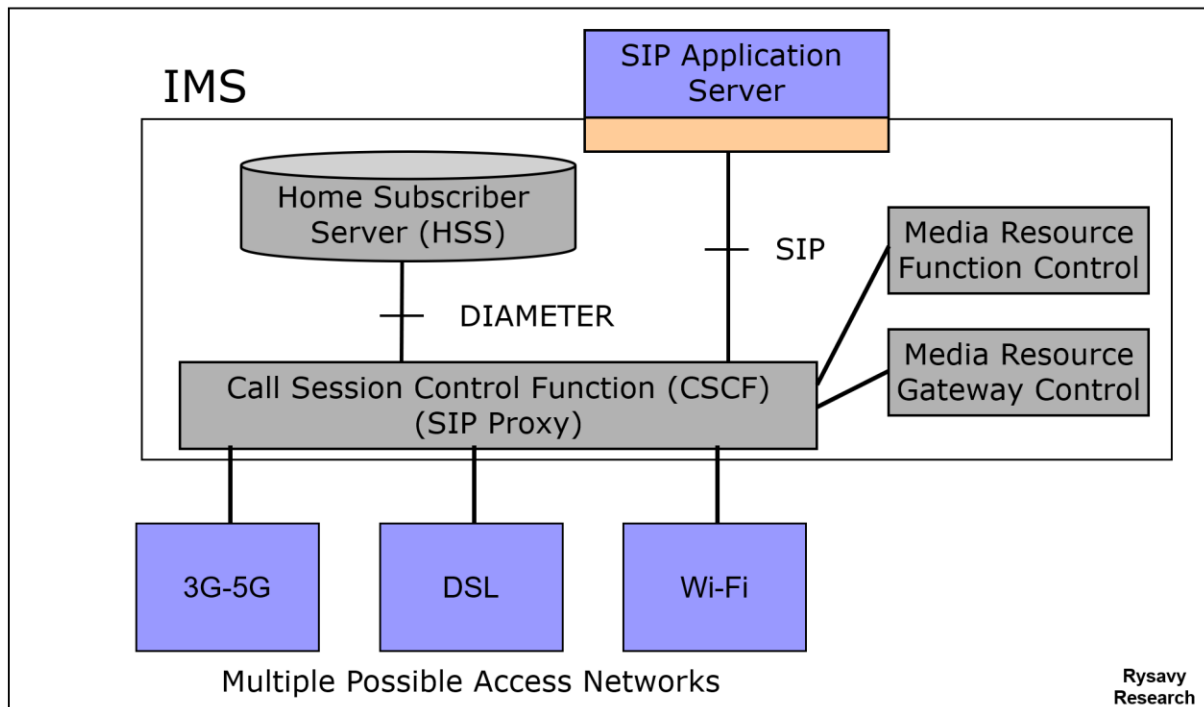

The benefits of using IMS include handling all communication in the packet domain, tighter integration with the internet, and a lower cost infrastructure based on IP building blocks for both voice and data services.

IMS applications can reside either in the operator’s network or in third-party networks including those of enterprises. By managing services and applications centrally—and independently of the access network—IMS can enable network convergence. This allows operators to offer common services across 3G, Wi-Fi, and wireline networks.

Service Continuity, defined in Release 8, provided for a user’s entire session to continue seamlessly as the user moves from one access network to another. Release 9 expanded this concept to allow sessions to move across different device types. For example, the user could transfer a video call in midsession from a mobile phone to a large-screen TV, assuming both have an IMS appearance in the network.

Release 8 introduced the IMS Centralized Services (ICS) feature, which allows for IMS-controlled voice features to use either packet-switched or circuit-switched access.

Given that LTE operators will integrate their 5G networks with their current LTE networks, operators are likely to keep using IMS in conjunction with LTE for their voice and other services that use IMS, even as they begin deploying 5G.

## Broadcast/Multicast Services

An important capability for 3G and evolved 3G systems is broadcasting and multicasting, wherein multiple users receive the same information using the same radio resource. This creates a more efficient approach to deliver video when multiple users desire the same content simultaneously. In a broadcast, every subscriber unit in a service area receives the information, whereas in a multicast, only users with subscriptions receive the information. Service areas for both broadcast and multicast can span either the entire network or a specific geographical area. Potential applications include sporting events, select news, venue-specific (shopping mall, museum) information, and even delivery of software upgrades. Giving users the ability to store and replay select content could further expand the scope of applications.

3GPP defined highly efficient broadcast/multicast capabilities for UMTS in Release 6 with MBMS. Release 7 defined optimizations through a feature called multicast/broadcast, single-frequency network operation that involves simultaneous transmission of the exact waveform across multiple cells. This enables the receiver to constructively superpose multiple MBMS Single Frequency Network (SFN), or MBSFN, cell transmissions. The result is highly efficient, WCDMA-based broadcast transmission technology that matches the benefits of OFDMA-based broadcast approaches.

LTE also has a broadcast/multicast capability called eMBMS. OFDM is particularly well suited for efficient broadcasting, as shown in Figure 151, because the mobile system can combine the signal from multiple base stations, also an MBSFN approach, and because of the narrowband nature of OFDM. Normally, these signals would interfere with one another. The single frequency network is a cluster of cells that transmit the same content synchronously with a common carrier frequency.

**Figure 151: OFDM Enables Efficient Broadcasting<sup>328</sup>**

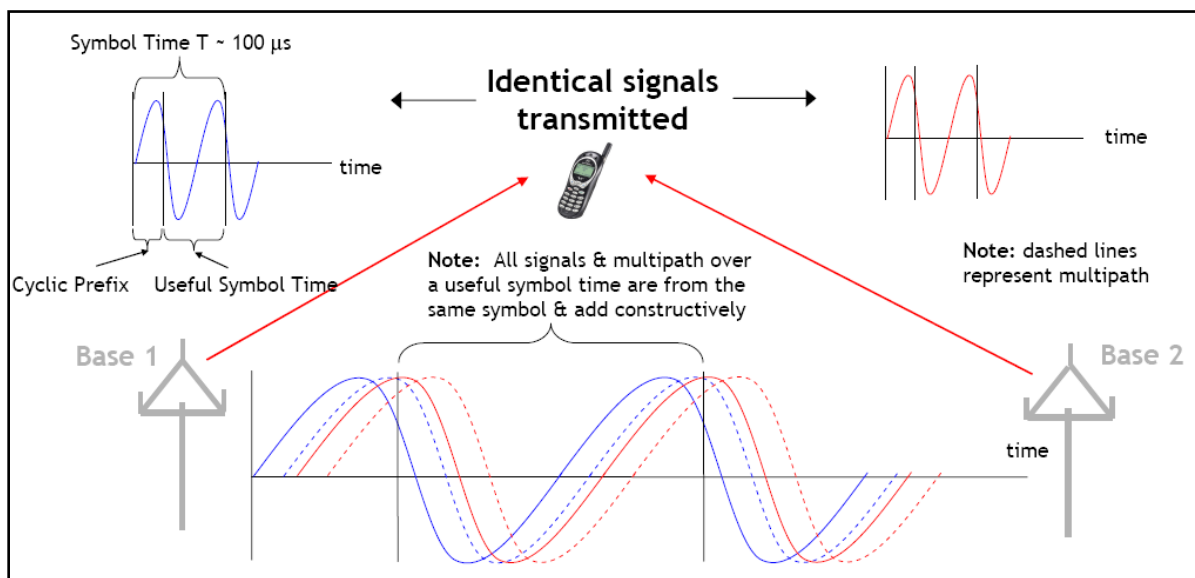

Despite various broadcast technologies being available, market adoption to date has been relatively slow. Internet trends have favored unicast approaches, with users viewing

<sup>328</sup> 5G Americas member contribution.

videos of their selection on demand, but there is increasing interest in using eMBMS with LTE to alleviate capacity demands.

## **Backhaul**

Connecting sites to core networks remains a challenge, whether for small cells or macro cells, especially as networks need to deliver higher bandwidth. Fiber is the gold standard, but it is not available everywhere and can be expensive, so operators use a combination of wired and wireless links.

Today's backhaul requirements for LTE can range from 1 to 10 Gbps. By 2020, backhaul requirements could exceed 10 Gbps.<sup>329</sup> 5G fronthauling using the eCPRI interface requires 25 Gbps capability, so sites may need connectivity to scale to 100 GE.<sup>330</sup>

Table 46 and Table 47 summarize the methods and capabilities of the various available approaches.

**Table 46: Wired Backhaul Methods and Capabilities<sup>331</sup>**

Technology	Distance	Throughput Speed
Direct Fiber	80 km	Hundreds of Mbps to Gbps
Bonded VDSL2	To 5,000 feet	75 Mbps down, 12 Mbps up
FTTX	Most urban areas	Up to 2.5 Gbps down, 1.5 Gbps up
DOCSIS	Most urban areas	Up to 285 Mbps down, 105 Mbps up

**Table 47: Wireless Backhaul Methods and Capabilities<sup>332</sup>**

Technology	Distance	Line-of-Sight	Throughput Speed
5G Integrated Access and Backhaul	1 km	Yes	1 to 10 Gbps
Millimeter Wave (60 GHz)	1 km	Yes	1 Gbps
Millimeter Wave (70-80 GHz)	3 km (with speed tradeoff)	Yes	10 Gbps

<sup>329</sup> Arthur D. Little, *Creating a Gigabit Society – The Rule of 5G*; A report by Arthur D. Little for Vodafone Group, 2017. See Figure 6.

<sup>330</sup> Ericsson, Fierce Markets Custom Publishing, *Meeting the 5G Backhaul Challenge*, Feb. 2019.

<sup>331</sup> Small Cell Forum, "Backhaul Technologies for Small Cells," Feb. 2013.

<sup>332</sup> Ibid.

Technology	Distance	Line-of-Sight	Throughput Speed
Microwave (6-60 GHz)	Varies by frequency: 2-4 km typical at 30-42 GHz	Yes	1 Gbps+
Licensed sub 6 GHz	1.5 to 10 km	No	170 Mbps (20 MHz TDD), 400 Mbps+ with new technology
Unlicensed sub-6 GHz	Up to 250 meters	No	450 Mbps (IEEE 802.11n 3X3 MIMO)
TV White Space (802.11af-based)	1 to 5 km max throughput, 10 km+ possible	Depends on deployment model	80 Mbps in 6 MHz TDD with 4X4 MIMO
Satellite	Available everywhere	Yes	Up to 50 Mbps downlink, 15 Mbps uplink

## Remote SIM Provisioning

The GSM Association (GSMA) is developing specifications that make it possible for consumers to purchase unprovisioned devices, select the operator of their choice and then download the subscriber identity module (SIM) application into the device.<sup>333</sup> This capability benefits devices such as watches, health bands, health monitors, and other small connected items.

## Abbreviations and Acronyms

The following abbreviations are used in this paper. Abbreviations are defined on first use.

1G – First Generation

1xEV-DO – One Carrier Evolution, Data Optimized

1xEV-DV – One Carrier Evolution, Data Voice

1XRTT – One Carrier Radio Transmission Technology

2G – Second Generation

3G – Third Generation (meeting requirements set forth by the ITU IMT project)

3GPP – Third Generation Partnership Project

3GPP2 – Third Generation Partnership Project 2

4G – Fourth Generation (meeting requirements set forth by the ITU IMT-Advanced project)

5GAA – 5GAA Automotive Association

5GC – 5G Core

---

<sup>333</sup> For details, see GSMA, “A New SIM.” <https://www.gsma.com/rsp/>, viewed Jun. 8, 2017.

5G-NGC – 5G Next Generation Core  
5QI – 5G QoS Identifier  
8-PSK – Octagonal Phase Shift Keying  
AAS – Adaptive Antenna Systems  
ABR – Allocation Retention Priority  
ACK – Acknowledgment  
AGW – Access Gateway  
AF – Application Functions  
AMF – Access and Mobility Management Function  
AMPS – Advanced Mobile Phone Service  
AMR – Adaptive Multi Rate  
AMR-WB – Adaptive Multi-Rate Wideband  
ANDSF – Access Network Discovery and Selection Function.  
ANSI – American National Standards Institute  
APCO – Association of Public Safety Officials  
API – Application Programming Interface  
APN – Access Point Name  
ARP – Allocation Retention Priority  
ARPU – Average Revenue per User  
ARQ – Automatic Repeat Request  
ASN.1 – Abstract Syntax Notation One  
ATM – Asynchronous Transfer Mode  
AUL – Autonomous Uplink  
AUSF – Authentication Server Function  
AWGN – Additive White Gaussian Noise Channel  
AWS – Advanced Wireless Services  
BBU – Baseband Unit  
BCCH – Broadcast Control Channel  
BFD – Beam Failure Detection  
bps – Bits per Second  
BRS – Broadband Radio Service  
BSC – Base Station Controller  
BTS – Base Transceiver Station  
BWP – Bandwidth Part  
C/I – Carrier to Intermodulation Ratio  
CAPEX – Capital Expenditure  
CAPIF – Common API Framework  
CBF – Coordinated Beam Forming  
CBRS – Citizens Broadband Radio Service  
CBS – Coordinated Beam Switching

CSS3 – Cascading Style Sheets 3 (CSS3)  
CDD – Cyclic Delay Diversity  
CDF – Cumulative Distribution Function  
CDMA – Code Division Multiple Access  
CL – Closed Loop  
CL-SM – Closed Loop Spatial Multiplexing  
CMAS – Commercial Mobile Alert System  
CMOS – Complementary Metal Oxide Semiconductor  
CNF – Containerized Network Function  
COLTs – Cell on Light Trucks  
CoMP – Coordinated Multi Point  
COT – Channel Occupancy Time  
COW – Cell on Wheels (also Cell on Wings)  
cMTC – Critical Machine Type Communications  
CP – Control Plane  
CP – Cyclic Prefix  
CPC – Continuous Packet Connectivity  
CPRI – Common Public Radio Interface  
CQI – Channel Quality Indicators  
C-RAN – Cloud Radio Access Network  
CRM – Customer Relationship Management  
CRS – Cell-specific Reference Signal  
CS – Convergence Sublayer  
CSFB – Circuit-Switched Fallback  
CTIA – Cellular Telephone Industries Association  
CU – Centralized Unit  
CUPS – Control User Plane Separation  
C-V2X – Cellular Vehicle-to-Everything  
D-AMPS – Digital Advanced Mobile Phone Service  
DAS – Distributed Antenna System  
DAS – Downlink EGPRS2-A Level Scheme  
dB – Decibel  
DBS – Downlink EGPRS2-B Level Scheme  
DC-HSPA – Dual Carrier HSPA  
DFT – Discrete Fourier Transform  
DU – Distributed Unit  
DL – Downlink  
DNS – Domain Name Service  
DPCCH – Dedicated Physical Control Channel  
DPS – Dynamic Point Selection



DSL – Digital Subscriber Line  
DSMIPv6 – Dual Stack Mobile IPv6  
DSRC – Dedicated Short Range Communications  
DSS – Dynamic Spectrum Sharing  
DTM – Dual Transfer Mode  
DRX – Discontinuous Reception  
D-TxAA – Double Transmit Adaptive Array  
DVB-H – Digital Video Broadcasting Handheld  
E-DCH – Enhanced Dedicated Channel  
EBCMCS – Enhanced Broadcast Multicast Services  
EC-GSM – Extended Coverage GSM  
eCoMP – Enhanced CoMP  
eCPRI – Enhanced Common Public Radio Interface  
EDGE – Enhanced Data Rates for GSM Evolution  
EFTA – Enhanced Flexible Timeslot Assignment  
EGPRS – Enhanced General Packet Radio Service  
eCAPIF – Enhanced Common API Framework  
eICIC – Enhanced Inter-Cell Interference Coordination  
eMBMS – Enhanced Multimedia Broadcast Multicast Services  
eNodeB – Evolved Node B  
EAP – Extensible Authentication Protocol  
eLAA – Enhanced Licensed-Assisted Access  
eNB – Evolved Node B  
EPC – Evolved Packet Core  
EPDCCH – Enhanced Physical Downlink Control Channel  
eMBB – Enhanced Mobile Broadband  
EN-DC – E-UTRAN New Radio Dual Connectivity  
ePDG – Enhanced Packet Data Gateway  
EPS – Evolved Packet System  
ERP – Enterprise Resource Planning  
eSaMOG – Enhanced S2a-based Mobility over GTP  
ESC – Environmental Sensing Capability  
eSRVCC – Enhanced Single-Radio Voice Call Continuity  
ETRI – Electronic and Telecommunications Research Institute  
ETSI – European Telecommunications Standards Institute  
E-UTRAN – Enhanced UMTS Terrestrial Radio Access Network  
EVS – Enhanced Voice Services (codec)  
FE-FACH – Further Enhanced Forward Access Channel  
EV-DO – Evolution, Data Optimized  
EV-DV – Evolution, Data Voice

EVRC – Enhanced Variable Rate Codec  
FBMC – Filter-Bank Multi-Carrier  
FCC – Federal Communications Commission  
FDD – Frequency Division Duplex  
FeCoMP – Further Enhanced Coordinated Multi Point  
feICIC – Further enhanced ICIC  
FirstNet – First Responder Network Authority  
Flash OFDM – Fast Low-Latency Access with Seamless Handoff OFDM  
FLO – Forward-Link Only  
FMC – Fixed Mobile Convergence  
FP7 – Seventh Framework Programme  
FR-1 – Frequency Range 1  
FR-2 – Frequency Range 2  
FRMCS - Future Railway Mobile Communication System  
FTP – File Transfer Protocol  
GAA – General Authorized Access  
GAN – Generic Access Network  
GB – Gigabyte  
Gbps – Gigabits Per Second  
GBR – Guaranteed Bit Rate  
GByte – Gigabyte  
GCS – Group Communication Service  
GERAN – GSM EDGE Radio Access Network  
GFDM – Generalized Frequency Division Multiplexing  
GGSN – Gateway GPRS Support Node  
GHz – Gigahertz  
GMSK – Gaussian Minimum Shift Keying  
gNB – NR NodeB  
GNSS – Global Navigation Satellite System  
GPRS – General Packet Radio Service  
G-Rake – Generalized Rake Receiver  
GSM – Global System for Mobile Communications  
GSMA – GSM Association  
GTP – GPRS Tunneling Protocol  
GTP-U – GTP User  
HAPS – High Altitude Platform Station  
HARQ – Hybrid Automatic Repeat Request  
HD – High Definition  
HetNet – heterogeneous network  
HFC – Hybrid Fiber Coaxial

HLR – Home Location Register  
Hr – Hour  
HSDPA – High Speed Downlink Packet Access  
HS-FACH – High Speed Forward Access Channel  
HS-PDSCH - High Speed Physical Downlink Shared Channel  
HS-RACH – High Speed Reverse Access Channel  
HSPA – High Speed Packet Access (HSDPA with HSUPA)  
HSPA+ – HSPA Evolution  
HSS – Home Subscriber Server  
HSUPA – High Speed Uplink Packet Access  
Hz – Hertz  
IAB – Integrated Access and Backhaul  
ICIC – Inter-Cell Interference Coordination  
ICN – Information-Centric Networking  
ICS – IMS Centralized Services  
ICT – Information and Communication Technologies  
IEEE – Institute of Electrical and Electronic Engineers  
IETF – Internet Engineering Taskforce  
IFFT – Inverse Fast Fourier Transform  
IFOM – IP Flow and Seamless Offload  
IM – Instant Messaging  
IMS – IP Multimedia Subsystem  
IMT – International Mobile Telecommunications  
IMT-Advanced - International Mobile Telecommunications-Advanced  
IRC – Interference Rejection Combining  
IoT – Internet of Things  
IPR - Intellectual Property Rights  
IP – Internet Protocol  
IPTV – Internet Protocol Television  
IR – Incremental Redundancy  
ISD – Inter-site Distance  
ISI – Intersymbol Interference  
ISP – Internet Service Provider  
ITU – International Telecommunication Union  
JCP – Java Community Process  
JR – Joint Reception  
JT – Joint Transmission  
Kbps – Kilobits Per Second  
kHz – Kilohertz  
km – Kilometer

LAA – License-Assisted Access  
LBT – Listen-Before-Talk  
LDPC - Low-Density Parity Code  
LEO – Low Earth Orbit  
LIPA – Local IP Access  
LMDS – Local Multipoint Distribution Service  
LMR – Land Mobile Radio  
LEO – Low Earth Orbiting  
LPP – LTE Positioning Protocol  
LPWA – Low-Power Wide-Area  
LTE – Long Term Evolution  
LTE-A – LTE-Advanced  
LTE-TDD – LTE Time Division Duplex  
LTE-U – LTE-Unlicensed  
LSTI – LTE/SAE Trial Initiative  
LWA – LTE Wi-Fi Aggregation  
LWIP – LTE WLAN Radio Level Integration with IPsec Tunnel  
M2M – Machine to machine  
MAC – Medium-Access Control  
MAPCON – Multi-Access PDN Connectivity  
MB - Megabyte  
MBMS - Multimedia Broadcast/Multicast Service  
Mbps – Megabits Per Second  
MBR – Maximum Bit Rate  
MBSFN – Multicast/broadcast, Single Frequency  
MCPA – Mobile Consumer Application Platform  
Mcps – Megachips Per Second  
MCPTT – Mission-Critical Push-to-Talk  
MCS – Modulation and Coding Scheme  
MCW – Multiple Codeword  
MDAF – Management Data Analytics Function  
MDAS – Management Data Analytics Services  
MDT – Minimization of Drive Tests  
MEAP – Mobile Enterprise Application Platforms  
MEC – Multi-access Edge Computing  
MediaFLO – Media Forward Link Only  
METIS – Mobile and wireless communications Enablers for the Twenty-twenty Information Society  
MHz – Megahertz  
MID – Mobile Internet Devices

MIMO – Multiple Input Multiple Output  
MMSE – Minimum Mean Square Error  
mITF – Japan Mobile IT Forum  
MMDS – Multichannel Multipoint Distribution Service  
MME – Mobile Management Entity  
mMTC – Massive Machine Type Communications  
MOS – Mean Opinion Score  
MP-QUIC – Multipath Quick UDP Internet Connections  
MP-TCP – Multipath TCP  
MRxD – Mobile Receive Diversity  
ms – Millisecond  
MS – Mobile Station  
MSA – Mobile Service Architecture  
MSC – Mobile Switching Center  
MTC – Machine Type Communications  
MTC-IWF – Machine-Type Communications Interworking Function (MTC-IWF)  
msec – Millisecond  
MU-MIMO – Multi-User MIMO  
MUST – Downlink Multiuser Superposition Transmission  
NAICS – Network-Assisted Interference Cancellation and Suppression  
NAK – Negative Acknowledgment  
NB-IoT – Narrowband Internet of Things  
NEF – Network Exposure Function  
NF – Network Function  
NENA – National Emergency Number Association  
NFVi – Network Function Virtualization Infrastructure  
NGC – Next Generation Core  
NGMC – Next Generation Mobile Committee  
NGMN – Next Generation Mobile Networks Alliance  
NG-RAN – New Generation Radio Access Network  
NMT – Nordic Mobile Telephone  
NOMA – Non-Orthogonal Multiple Access  
NPRM – Notice of Proposed Rulemaking  
NR – New Radio  
NRF – NF Repository Function  
NR-U – New Radio Unlicensed  
NSA – Non-Standalone  
NSSF – Network Slice Selection Function  
NTIA – National Telecommunications and Information Administration  
NTN – Non Terrestrial Networks

NWDAF – Network Data Analytics Function  
OFDM – Orthogonal Frequency Division Multiplexing  
OFDMA – Orthogonal Frequency Division Multiple Access  
OL-SM – Open Loop Spatial Multiplexing  
OMA – Open Mobile Alliance  
ONAP – Open Network and Automation Platform  
O-RAN – Open Radio Access Network  
ORI – Open Radio Equipment Interface  
PA – Priority Access  
PAL – Priority Access License  
PAR – Peak to Average Ratio  
PBCCH – Packet Broadcast Control Channel  
PCF – Policy Control Function  
PCH – Paging Channel  
PCRF – Policy Control and Charging Rules Function  
PCS – Personal Communications Service  
PDCCH – Physical Downlink Control Channel  
PDCP – Packet Data Convergence Protocol  
PDN – Packet Data Network  
PDSCH – Physical Downlink Shared Channel  
PDU – Protocol Data Unit  
PGW – Packet Gateway  
PHY – Physical Layer  
PMI – Precoding Matrix Indication  
PMIPv6 – Proxy Mobile IPv6  
PNF – Physical Network Function  
PoC – Push-to-Talk Over Cellular  
PSH – Packet Switched Handover  
PSK – Phase-Shift Keying  
PUSCH – Physical Uplink Shared Channel  
QAM – Quadrature Amplitude Modulation  
QCI – Quality of Service Class Identifier  
QLIC – Quasi-Linear Interference Cancellation  
QoS – Quality of Service  
QPSK – Quadrature Phase Shift Keying  
QUIC – Quick UDP Internet Connections.  
RAB – Radio Access Bearer  
RAN – Radio Access Network  
RAN-DAF – RAN Data Analytics Function  
RCAF – RAN Congestion Awareness Function

RCLWI - RAN Controlled LTE WLAN Interworking  
RCS – Rich Communications Suite  
REST – Representational State Transfer  
RF – Radio Frequency  
RLC – Radio Link Control  
RNC – Radio Network Controller  
ROHC – Robust Header Compression  
RRC – Radio Resource Control  
RRH – Remote Radio Head  
RRU – Remote Radio Unit  
RS – Reference Signal  
RSRP – Reference Signal Received Power  
RTP – Real Time Transport Protocol  
RTSP – Real Time Streaming Protocol  
SA - Standalone  
SAE – System Architecture Evolution  
SaMOG – S2a-based Mobility over GTP  
SAS – Spectrum Access System  
SBA – Service-Based Architecture  
SC-FDMA – Single Carrier Frequency Division Multiple Access  
SCMA – Sparse Coded Multiple Access  
SCRI – Signaling Connection Release Indication  
SCS - Subcarrier Spacing  
SCW – Single Codeword  
SDAP – Service Data Adaptation Protocol  
SDMA – Space Division Multiple Access  
SDN – Software-Defined Networking  
SDP – Session Description Protocol  
sec – Second  
SEAL – Service Enabler Architecture Layer for Verticals  
SFBA – Space Frequency Block Code  
SFN – Single Frequency Network  
SGSN – Serving GPRS Support Node  
SGW – Serving Gateway  
SIC – Successive Interference Cancellation  
SIM – Subscriber Identity Module  
SIMO – Single Input Multiple Output  
SINR – Signal to Interference Plus Noise Ratio  
SIP – Session Initiation Protocol  
SIPTO – Selected IP Traffic Offload

SISO – Single Input Single Output  
SMF – Session Management Function  
SMS – Short Message Service  
SNR – Signal to Noise Ratio  
SON – Self-Organizing Network  
SPS – Semi-Persistent Scheduling  
SRIT – Set of Radio Interface Technologies  
SRS – Sounding Reference signal  
SRVCC – Single-Radio Voice Call Continuity  
SSB – Synchronization Signal Blocks  
SU-MIMO – Single User MIMO  
SVDO – Simultaneous 1XRTT Voice and EV-DO Data  
SVLTE – Simultaneous Voice and LTE  
TCH – Traffic Channel  
TCP/IP – Transmission Control Protocol/IP  
TD – Transmit Diversity  
TDD – Time Division Duplex  
TDMA – Time Division Multiple Access  
TD-SCDMA – Time Division Synchronous Code Division Multiple Access  
TD-CDMA – Time Division Code Division Multiple Access  
TETRA – Terrestrial Trunked Radio  
THz – Terahertz  
TIA/EIA – Telecommunications Industry Association/Electronics Industry Association  
TISPAN – Telecoms and Internet Converged Services and Protocols for Advanced Networks  
TRP – Time Relative Positioning  
TSG-RAN – Technical Services Group Radio Access Network  
TTI – Transmission Time Interval  
UAS – Uplink EGPRS2-A Level Scheme  
UAS – Unmanned Aerial System  
UAV – Unmanned Aerial Vehicle  
UBS – Uplink EGPRS2-B Level Scheme  
UE – User Equipment  
UFMC – Universal Filtered Multi-Carrier  
UICC – Universal Integrated Circuit Card  
UL – Uplink  
UMA – Unlicensed Mobile Access  
UMB – Ultra Mobile Broadband  
UMTS – Universal Mobile Telecommunications System  
UDM – United Data Management  
UPCON – User-Plane Congestion Management



UPF – User Plane Function  
URA-PCH – UTRAN Registration Area Paging Channel  
URI – Uniform Resource Identifier  
URLLC – Ultra-Reliable and Low Latency Communications  
us – Microsecond  
USIM – UICC SIM  
UTRAN – UMTS Terrestrial Radio Access Network  
V2I – Vehicle-to-Infrastructure  
V2P – Vehicle-to-Person  
V2V – Vehicle-to-Vehicle  
V2X – Vehicle-to-Anything  
VAMOS – Voice Services over Adaptive Multi-User Channels on One Slot  
VDSL – Very-High-Bit-Rate DSL  
VEPC – Virtualized EPC  
ViLTE – Video Over LTE  
VoIP – Voice over Internet Protocol  
VoHSPA – Voice over HSPA  
VoLGA – Voice over LTE Generic Access  
VoLTE – Voice over LTE  
VNF- Virtual Network Function  
VPN – Virtual Private Network  
WAP – Wireless Application Protocol  
WBA – Wireless Broadband Alliance  
WCDMA – Wideband Code Division Multiple Access  
WCS – Wireless Communication Service  
WebRTC – Web Real-Time Communication  
Wi-Fi – Wireless Fidelity  
WiMAX – Worldwide Interoperability for Microwave Access  
WLAN – Wireless Local Area Network  
WMAN – Wireless Metropolitan Area Network  
WMM – Wi-Fi Multimedia  
WRC – World Radiocommunication Conference  
XR- Extended Reality

## **Additional Information**

5G Americas maintains market information, LTE deployment lists, and numerous white papers, available for free download on its web site: <http://www.5gamericas.org>.